

HISTORY INFORMATION FOR THE FOLLOWING MANUAL:

SERVICE MANUAL

AX-1X CHASSIS

<u>MODEL NAME</u>	<u>REMOTE COMMANDER</u>	<u>DESTINATION</u>	<u>CHASSIS NO.</u>
KDP-51WS655	RM-Y915	US/HAWAII	SCC-M39A-A
KDP-57WS655	RM-Y915	US/HAWAII	SCC-M39B-A

ORIGINAL MANUAL ISSUE DATE: 8/2004

 :UPDATED ITEM

<u>REVISION DATE</u>	<u>SUBJECT</u>
8/2004	No revisions or updates are applicable at this time.
10/2004	Corrected Note from section 2-12-1. Setup For Adjustment. Note is intended for use by the factory during production, and should not be performed by service technicians. (Replaced Page 41 with Page 41)
3/2005	Added Caution statement (Replaced Page 6 with Page 6) Corrected service mode list (Replaced Page 25 with Page 25) Added BH Board (PN A-1071-980-A) PWB (Replaced Page 82 with Page 82) Added alternate BH Board PN to Exploded View section (Replaced Page 91 with Page 91) New CRTs & Shades introduced for KDP-51WS655 Affects SNs 8,500,001 and up Updated PN for Blue Shade and Lens for KDP-57WS655 New CRT Coupler Assemblies introduced for KDP-57WS655 Affects SNs 9,702,147-9,702,444 and 9,713,504 and up (Replaced Page 92 with Page 92)

COLOR REAR VIDEO PROJECTION

SONY[®]

SERVICE MANUAL

AX-1X CHASSIS

<u>MODEL NAME</u>	<u>REMOTE COMMANDER</u>	<u>DESTINATION</u>	<u>CHASSIS NO.</u>
KDP-51WS655	RM-Y915	US/HAWAII	SCC-M39A-A
KDP-57WS655	RM-Y915	US/HAWAII	SCC-M39B-A



KDP-51WS655



RM-Y915

COLOR REAR VIDEO PROJECTION

SONY®

TABLE OF CONTENTS

SECTION TITLE	PAGE	SECTION TITLE	PAGE
Specifications	4	4-3. P & P Sub-Hue and Sub-Color Adjustment Video (SHUE, SCOL)	51
Warnings and Cautions	6	4-4. P & P Sub-Hue and Sub-Color Adjustment (RF) (SHUE, SCOL)	51
Safety Check-Out	7	4-5. Blue Offset Adjustment	52
Self-Diagnostic Function	8	SECTION 5: DIAGRAMS	53
SECTION 1: DISASSEMBLY	11	5-1. Circuit Boards Location	53
1-1. Rear Board Removal	11	5-2. Printed Wiring Boards and Schematic Diagrams Information	53
1-2. Chassis Assembly Removal	11	5-3. Block Diagrams	55
1-3. Service Position	12	Power Block Diagram	55
1-4. Terminal Board, P Board AND Q Box Assembly Removal ...	12	Audio Signal Path Block Diagram	56
1-5. BH Board Removal	13	Video Path Block Diagram	57
1-6. A Board, D Board, and G Board Removal	13	SYNC/OSD Path Block Diagram	58
1-7. High-Voltage Cable Installation and Removal	14	5-4. Schematics and Supporting Information	59
1-8. Picture Tube Removal	14	CR Board Schematic Diagram	59
1-9. Speaker Grille, HA2 Board, and HB3 Board Removal	15	CB Board Schematic Diagram	60
1-10. Beznets Assembly Removal	16	CG Board Schematic Diagram	61
1-10-1. Screen Tape Method	16	VM Board Schematic Diagram	64
1-11. SR Board Removal	17	A Board Schematic Diagram (1 of 6)	65
Wire Dressing	18	A Board Schematic Diagram (2 of 6)	66
SECTION 2: SET-UP ADJUSTMENTS	22	A Board Schematic Diagram (3 of 6)	67
2-1. Screen Voltage Adjustment (G2) (Coarse Adjustment)	22	A Board Schematic Diagram (4 of 6)	68
2-2. Screen (G2) Adjustment (Fine Adjustment)	22	A Board Schematic Diagram (5 of 6)	69
2-3. Deflection Yoke Tilt Adjustment	22	A Board Schematic Diagram (6 of 6)	70
2-4. Focus Lens Adjustment	23	D Board Schematic Diagram (1 of 2)	75
2-5. Focus VR Adjustment	23	D Board Schematic Diagram (2 of 2)	76
2-6. Centering Magnet Adjustment	24	BH Board Schematic Diagram (1 of 2)	80
2-7. 2-Pole Magnet Adjustment	24	BH Board Schematic Diagram (2 of 2)	81
2-8. 4-Pole Magnet Adjustment	24	G Board Schematic Diagram	83
2-9. Defocus Adjustment (Blue)	24	HA2 Board Schematic Diagram	86
2-10. Electrical Adjustments by Remote Commander	25	P Board Schematic Diagram	87
2-10-1. Method of Entering the Service Adjustment Mode ..	25	SR Board Schematic Diagram	88
2-10-2. Memory Write Confirmation Method	25	HB3 Board Schematic Diagram	88
2-10-3. Adjusting Buttons and Indicator	25	SECTION 6: EXPLODED VIEWS	90
2-11. Adjustable Service Data Lists	26	6-1. Cover	90
2-11-1. ID Map Table	40	6-2. Chassis	91
2-12. Registration Adjustment (PJE Mode Only)	41	6-3. Picture Tube	92
2-12-1. Setup for Adjustment	41	SECTION 7: ELECTRICAL PARTS LIST	93
2-12-2. Main Deflection Adjustment	41		
2-12-3. Operation Method for Projector Engine Mode	42		
2-13. PJE Adjustment (Sub Deflection Adjustment)	43		
2-13-1. Adjustment for NTSC Full Mode	44		
2-13-2. Copying All Registration Data to Other Modes	46		
2-14. Auto Registration Offsets	46		
2-15. Auto Registration Error Codes	47		
2-16. Auto Registration Diagnostics	48		
SECTION 3: SAFETY-RELATED ADJUSTMENTS	49		
D BOARD	49		
3-1. HV Regulation Circuit Check and Adjustment	49		
3-2. HV Hold Down Circuit Operation Check	49		
G BOARD	50		
3-3. +B Max Voltage Confirmation	50		
3-4. +B OVP Confirmation	50		
SECTION 4: CIRCUIT ADJUSTMENTS	51		
4-1. P & P Sub Contrast Adjustment (Video) (SCON)	51		
4-2. P & P Sub Contrast Adjustment (RF) (SCON)	51		

SPECIFICATIONS

Power Requirements 120V AC, 60Hz

Power Consumption (W)

In Use (Max) 260W

In Standby Under 1 W

In CableCARD Standby Under 16 W

Inputs/Outputs HDMI IN

Video

1080i, 720p, 480p, 480i

Audio

Two channel linear PCM 32, 44.1, and 48 kHz, 16, 20, and 24 bit

Video (IN)

4 total (1 on front panel)

1Vp-p, 75ohms unbalanced, sync negative

S Video (IN)

3 total (1 on front panel)

Y: 1Vp-p, 75ohms unbalanced, sync negative

C: 0.286Vp-p (Burst signal), 75ohms

Digital Audio Optical Output

PCM/Dolby Digital

1 Total

Optical Rectangular

Audio (IN)

7 total (1 on front panel)

500 mVrms (100% modulation)

Impedance:47 kilohm

Component Video Input

2 (Y,P_B,P_R)

Y: 1.0 Vp-p, 75 ohms unbalanced, sync negative;

P_B: 0.7 Vp-p, 75 ohms;

P_R: 0.7 Vp-p, 75 ohms

Control S (IN/OUT)

1 total

Variable/Fixed Audio (OUT)

More than 408 m Vrms (Variable) at the maximum volume setting

More than 408 m Vrms (Fixed) Impedance (output):2 kilohms

CableCARD Slot

PCMCIA Type I/II

	KDP-51WS655	KDP-57WS655
Speaker Output (W)	20W x 2	
Dimensions (W x H x D)		
mm	1194 x 1280 x 666 mm	1326 x 1377 x 692 mm
in	47 x 50 ^{1/2} x 26 ^{1/4} in	52 ^{1/4} x 54 ^{1/4} x 27 ^{1/4} in
Mass		
kg	79.6 kg	92.3 kg
lbs	175.5 lbs	203.5 lbs

CableCARD™ is a trademark of Cable Television Laboratories, Inc.

TruSurround, SRS and the (●)® symbol are trademarks of SRS Labs, Inc.

TruSurround technology is incorporated under license from SRS Labs, Inc.

BBE and BBE Symbol are trademarks of BBE Sound, Inc. and are licensed by BBE Sound, Inc. under U.S. Patent No. 4,638,258 and 4,482,866.



Manufactured under license from Dolby Laboratories Licensing Corporation. Dolby and the double-D symbol are trademarks of Dolby Laboratories Licensing Corporation.



This TV incorporates High-Definition Multimedia Interface (HDMI™) technology. HDMI, the HDMI logo and High-Definition Multimedia Interface are trademarks or registered trademarks of HDMI Licensing LLC.

WEGA, Steady Sound, Digital Reality Creation, CineMotion, Memory Stick, Memory Stick Duo, Memory Stick PRO, Memory Stick PRO Duo, MagicGate, MID and Twin View are trademarks of Sony Corporation.

Projection System

3 picture tubes, 3 lenses, horizontal in-line system

Picture Tube

7-inch high-brightness monochrome tubes (6.3 raster size),
with optical coupling and liquid cooling system.

Projection Lenses

High performance, large diameter hybrid lens F1.1

Antenna

75 ohm external terminal for VHF/UHF

Television System

NTSC, American TV Standard
ATSC (8VSB terrestrial) ATSC compliant 8VSB
QAM on cable ANSI/SCTE 07 2000

Channel Coverage

Terrestrial (analog)	2-69
Cable TV (analog)	1-125
Terrestrial (digital)	2-69
Cable TV (digital)	1-135

Screen Size (measured diagonally)

51 inches (KDP-51WS655)

57 inches (KDP-57WS655)

Supplied Accessories

Remote Control RM-Y915

Batteries (2) size AA (R6)

Optional Accessories

AV Cable (VMC-810/820/830 HG)

Audio Cable (RKC-515HG)

Component Video Cable (VMC-10/30 HG)

WARNINGS AND CAUTIONS

CAUTION

 These servicing instructions are for use by qualified service personnel only. To reduce the risk of electric shock, do not perform any servicing other than that contained in the operating instructions unless you are qualified to do so.

WARNING!!

An isolation transformer should be used during any service to avoid possible shock hazard, because of live chassis. The chassis of this receiver is directly connected to the ac power line.

SAFETY-RELATED COMPONENT WARNING!!

Components identified by shading and  mark on the schematic diagrams, exploded views, and in the parts list are critical for safe operation. Replace these components with Sony parts whose part numbers appear as shown in this manual or in supplements published by Sony. Circuit adjustments that are critical for safe operation are identified in this manual. Follow these procedures whenever critical components are replaced or improper operation is suspected.

ATTENTION!!

 Ces instructions de service sont à l'usage du personnel de service qualifié seulement. Pour prévenir le risque de choc électrique, ne pas faire l'entretien autre que celui contenu dans le Mode d'emploi à moins que vous soyez qualifié faire ainsi.

Afin d'éviter tout risque d'électrocution provenant d'un châssis sous tension, un transformateur d'isolement doit être utilisé lors de tout dépannage. Le châssis de ce récepteur est directement raccordé à l'alimentation du secteur.

ATTENTION AUX COMPOSANTS RELATIFS A LA SECURITE!!

Les composants identifiés par une trame et par une marque  sur les schémas de principe, les vues explosées et les listes de pièces sont d'une importance critique pour la sécurité du fonctionnement. Ne les remplacer que par des composants Sony dont le numéro de pièce est indiqué dans le présent manuel ou dans des suppléments publiés par Sony. Les réglages de circuit dont l'importance est critique pour la sécurité du fonctionnement sont identifiés dans le présent manuel. Suivre ces procédures lors de chaque remplacement de composants critiques, ou lorsqu'un mauvais fonctionnement suspecte.

SAFETY CHECK-OUT

After correcting the original service problem, perform the following safety checks before releasing the set to the customer:

1. Check the area of your repair for unsoldered or poorly soldered connections. Check the entire board surface for solder splashes and bridges.
2. Check the interboard wiring to ensure that no wires are "pinched" or touching high-wattage resistors.
3. Check that all control knobs, shields, covers, ground straps, and mounting hardware have been replaced. Be absolutely certain that you have replaced all the insulators.
4. Look for unauthorized replacement parts, particularly transistors, that were installed during a previous repair. Point them out to the customer and recommend their replacement.
5. Look for parts which, though functioning, show obvious signs of deterioration. Point them out to the customer and recommend their replacement.
6. Check the line cords for cracks and abrasion. Recommend the replacement of any such line cord to the customer.
7. Check the B+ and HV to see if they are specified values. Make sure your instruments are accurate; be suspicious of your HV meter if sets always have low HV.
8. Check the antenna terminals, metal trim, "metallized" knobs, screws, and all other exposed metal parts for AC leakage. Check leakage as described below.

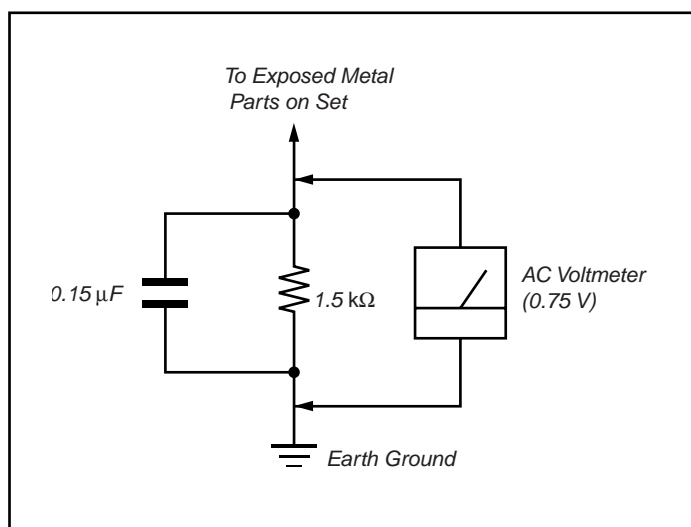

Figure A. Using an AC voltmeter to check AC leakage.

Leakage Test

The AC leakage from any exposed metal part to earth ground and from all exposed metal parts to any exposed metal part having a return to chassis, must not exceed 0.5 mA (500 microamperes). Leakage current can be measured by any one of three methods.

1. A commercial leakage tester, such as the Simpson 229 or RCA WT-540A. Follow the manufacturers' instructions to use these instructions.
2. A battery-operated AC milliammeter. The Data Precision 245 digital multimeter is suitable for this job.
3. Measuring the voltage drop across a resistor by means of a VOM or battery-operated AC voltmeter. The "limit" indication is 0.75 V, so analog meters must have an accurate low voltage scale. The Simpson's 250 and Sanwa SH-63TRD are examples of passive VOMs that are suitable. Nearly all battery-operated digital multimeters that have a 2 VAC range are suitable (see Figure A).

How to Find a Good Earth Ground

A cold-water pipe is a guaranteed earth ground; the cover-plate retaining screw on most AC outlet boxes is also at earth ground. If the retaining screw is to be used as your earth ground, verify that it is at ground by measuring the resistance between it and a cold-water pipe with an ohmmeter. The reading should be zero ohms.

If a cold-water pipe is not accessible, connect a 60- to 100-watt trouble-light (not a neon lamp) between the hot side of the receptacle and the retaining screw. Try both slots, if necessary, to locate the hot side on the line; the lamp should light at normal brilliance if the screw is at ground potential (see Figure B).

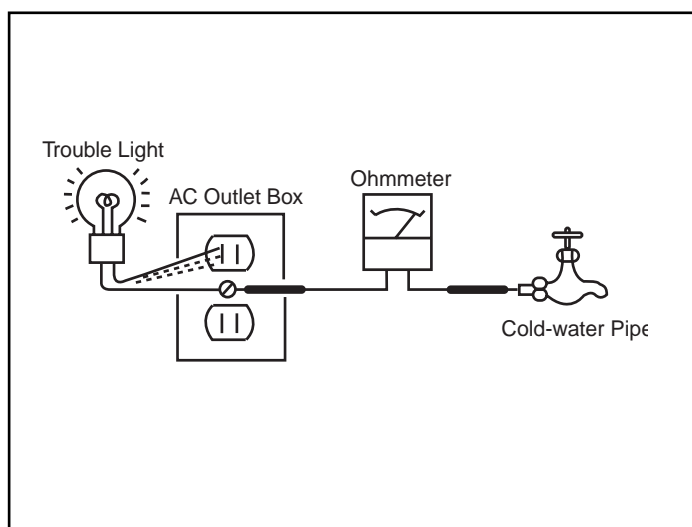

Figure B. Checking for earth ground.

SELF-DIAGNOSTIC FUNCTION



The units in this manual contain a self-diagnostic function. If an error occurs, the STANDBY/TIMER LED will automatically begin to flash. The number of times the LED flashes translates to a probable source of the problem. A definition of the STANDBY/TIMER LED flash indicators is listed in the instruction manual for the user's knowledge and reference. If an error symptom cannot be reproduced, the Remote Commander can be used to review the failure occurrence data stored in memory to reveal past problems and how often these problems occur.

Diagnostic Test Indicators

When an error occurs, the STANDBY/TIMER LED will flash a set number of times to indicate the possible cause of the problem. If there is more than one error, the LED will identify the first of the problem areas.

Results for all of the following diagnostic items are displayed on screen. If the screen displays a "0", no error has occurred.

Diagnostic Item	No. of times STANDBY / TIMER lamp flashes	Display Result	Probable Cause Location	Detected Symptoms
Power does not turn on	Does not light	_____	<ul style="list-style-type: none"> Power cord is not plugged in. Fuse is burned out (F6000). (G Board) 	<ul style="list-style-type: none"> Power does not come on. No power is supplied to the TV. AC Power supply is faulty.
+B Overcurrent (OCP)*	2 times	2:0 or 2:1	<ul style="list-style-type: none"> H.OUT (Q5001) is shorted. (D Board) +B PWM (Q5201) is shorted. (D Board) 	<ul style="list-style-type: none"> Power does not come on. Load on power line shorted.
+B Overvoltage (OVP)	3 times	3:0 or 3:1	<ul style="list-style-type: none"> IC6503 is faulty. (D Board) 	<ul style="list-style-type: none"> Has entered standby mode.
Vertical Deflection Stopped	4 times	4:0 or 4:1	<ul style="list-style-type: none"> 15V is not supplied. (D Board) IC5101 is faulty. (D Board) 	<ul style="list-style-type: none"> Has entered standby mode after Horizontal raster. Vertical deflection pulse is stopped. Power line is shorted or power supply is stopped.
White Balance Failure (not balanced)	5 times	5:0 or 5:1	<ul style="list-style-type: none"> Video OUT (IC9101, IC9201, IC9301) is faulty. (CR, CG, CB Board) CRT drive (IC452) is faulty. (A Board) G2 is improperly adjusted.** 	<ul style="list-style-type: none"> No raster is generated. CRT cathode current detection reference pulse output is small.
LOW +B OCP/OVP (overcurrent/overvoltage)***	6 times	6:0 or 6:1	<ul style="list-style-type: none"> +5 line is overloaded. (A and BH Boards) +5 line is shorted. (A and BH Boards) IC303 is faulty. (A Board) 	<ul style="list-style-type: none"> No picture
Horizontal Deflection Stopped	7 times	7:0 or 7:1	<ul style="list-style-type: none"> Q5006 is broken (D Board) IC452 is faulty (A Board) 	<ul style="list-style-type: none"> No picture
Audio Protection	8 times	8:0 or 8:1	<ul style="list-style-type: none"> + or - 22V audio supply is not present—Check PS600 & PS601 Audio AMP is damaged IC601 on A Board 	<ul style="list-style-type: none"> No picture
Zero Crossing Detector	9 times	9:0 or 9:1	<ul style="list-style-type: none"> D6116 or D6301 is open (G Board) 	<ul style="list-style-type: none"> No picture
HV Protection	10 times	10:0 or 10:1	<ul style="list-style-type: none"> Q8014 or Q8013 have shorted replace along with R8051 on D Board IC8005 is damaged (D Board) 	<ul style="list-style-type: none"> No picture

* If a +B overcurrent is detected, stoppage of the vertical deflection is detected simultaneously. The symptom that is diagnosed first by the microcontroller is displayed on the screen.

** Refer to Screen (G2) Adjustment (Fine Adjustments) in Section 2 of this manual.

*** If STANDBY/STEREO LED flashes six (6) times, unplug the unit and wait 10 seconds before performing the adjustment.

Display of Standby/Timer LED Flash Count

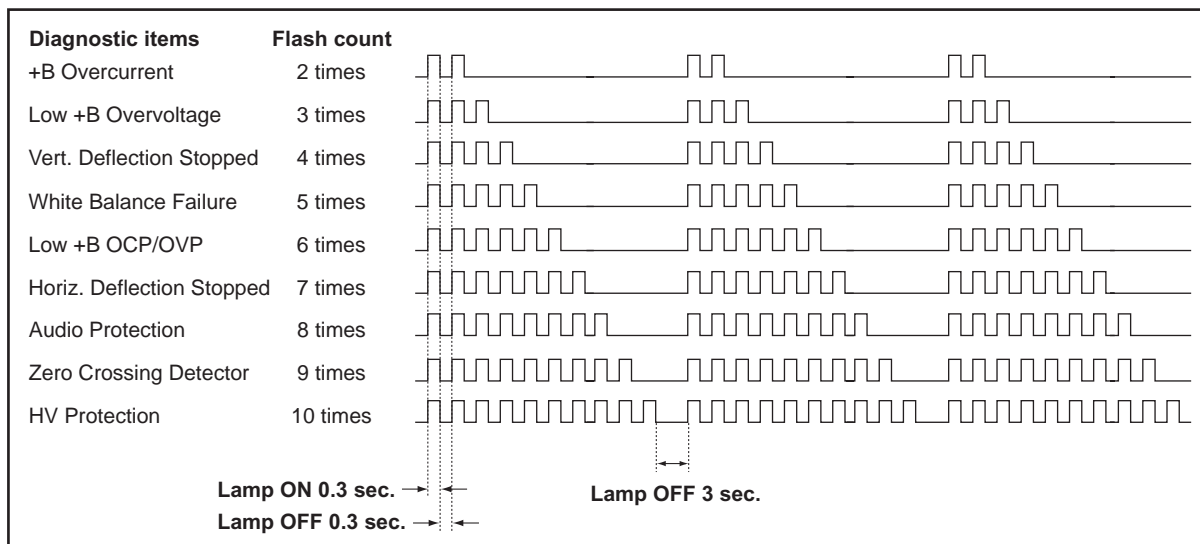
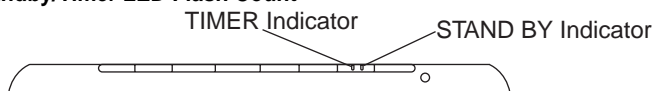

Release of TIMER STAND BY indicator blinking

The TIMER/STANDBY indicator blinking display is released by turning OFF the power switch on the TV main unit or removing the plug from the power.

Self-Diagnosis Screen Displays

In cases of malfunctions where it is not possible to determine the symptom such as when the power goes off occasionally or when the screen disappears occasionally, there is a screen display on whether the malfunction occurred or not in the past (and whether the detection circuit operated or not) in order to allow confirmation.

Screen Display Method

Quickly press the remote command button in the following order from the standby state.

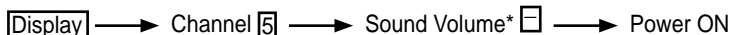

SELF DIAGNOSIS	
2: +B OCP	0
3: +B OVP	0
4: VSTOP	0
5: AKB	1
6: LOWB	0
7: H-STOP	0
8: AUDIO	0
9: ZCD	0
10: HV PROT	0
101: WDT	24

*Note that this differs from entering the service mode (sound volume []))

Numeral "0" means that no fault was detected.
 Numerical "1" means a fault was detected one time only.

Self-Diagnosis Screen Display

The results display is not automatically cleared. In case of repairs and after repairs, check the self-diagnosis screen and be sure to return the results display to " 0 ".

If the results display is not returned to " 0 " it will not be possible to judge a new malfunction after completing repairs.

Method of Clearing Results Display

1. Power off (Set to the stand by mode.)
2. [Display] → Channel [5] → Sound Volume [] → Power ON (Service Mode)
3. Channel [8] → [ENTER] (Test reset = Factory preset condition)

Method of Ending Self Diagnosis Screen

When ending the self-diagnosis screen completely, turn the power switch OFF on the remote commander or the main unit.

Self-Diagnosis Function Operation

+B overcurrent (OCP)

Occurs when excessive current flows through R6812. The increase in voltage across Q6803 causes it to turn on which sends a high signal to the micro.

+B overvoltage (OVP)

IC6801 detects +B OVP condition and turns on Q6802. This sends a high signal to the micro and also shuts down the AC relay.

V-STOP

Occurs when an absence of the vertical deflection pulse is detected by pin 56 of IC452 (A Board). Power supply will shut down when waveform interval exceeds 2 seconds.

White Balance Failure

If the RGB levels* do not balance within 2 seconds after the power is turned on, this error will be detected by IC452 (A Board). TV will stay on, but there will be no picture.

* (Refers to the RGB levels of the AKB detection Ref pulse that detects 1K).

Low B OCP/OVP

Occurs when set 5V is out.

- Also check for : + 135V line shorted
- + 135V line is going over 145V

Horizontal Deflection Stopped

Occurs when either:

- 1) a +B overcurrent is detected (Q6803), or
- 2) IC452 (A Board) is damaged.

Self-Diagnosis Block Diagram

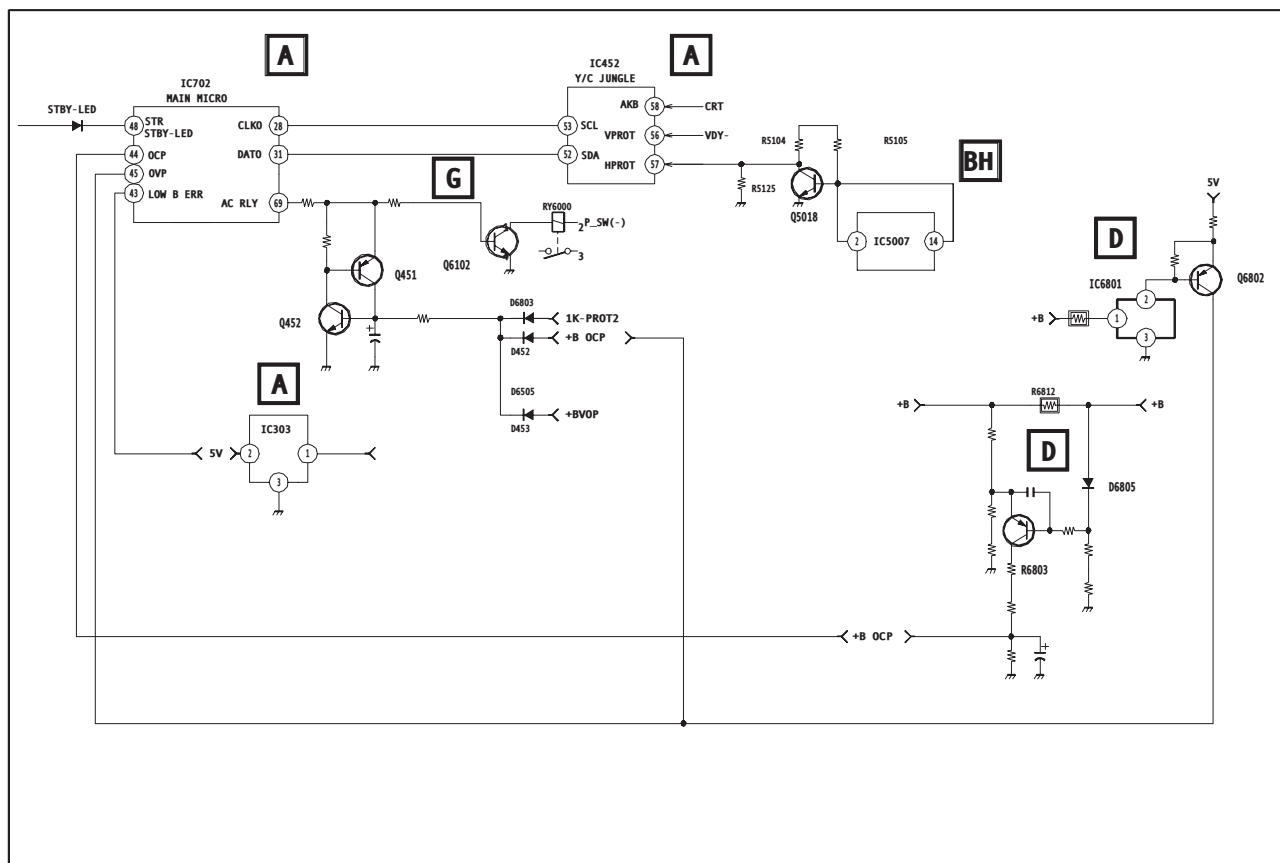

SECTION 1: DISASSEMBLY

1-1. REAR BOARD REMOVAL

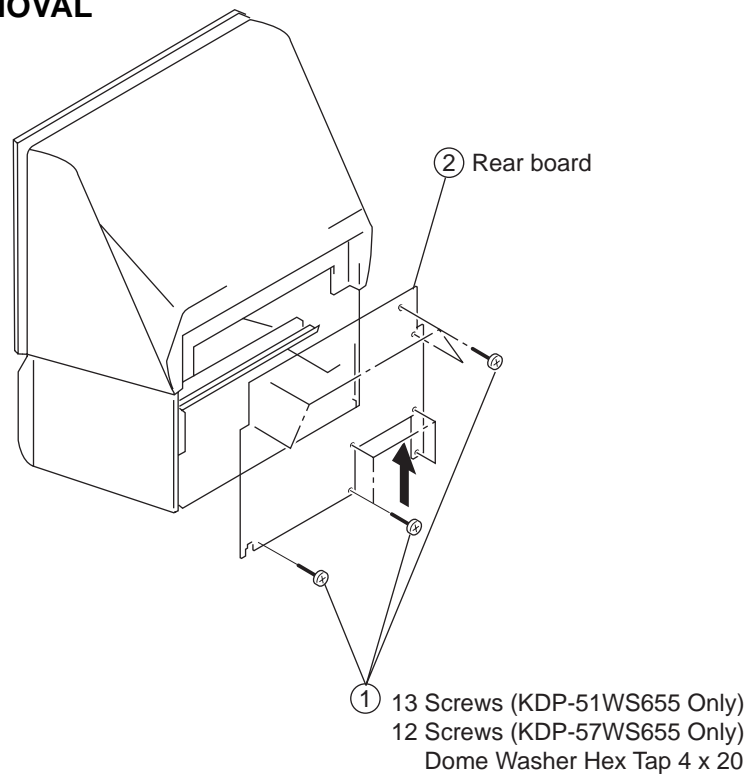

1-2. CHASSIS ASSEMBLY REMOVAL

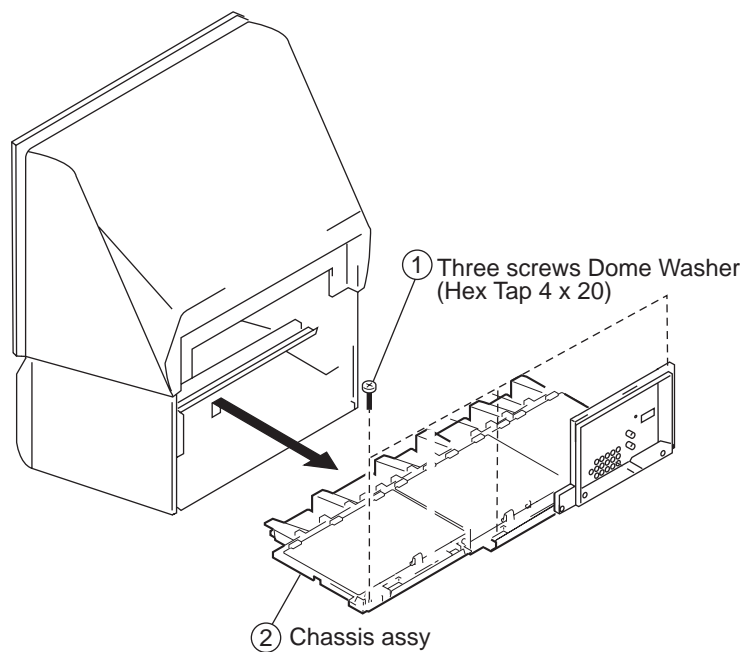

1-3. SERVICE POSITION

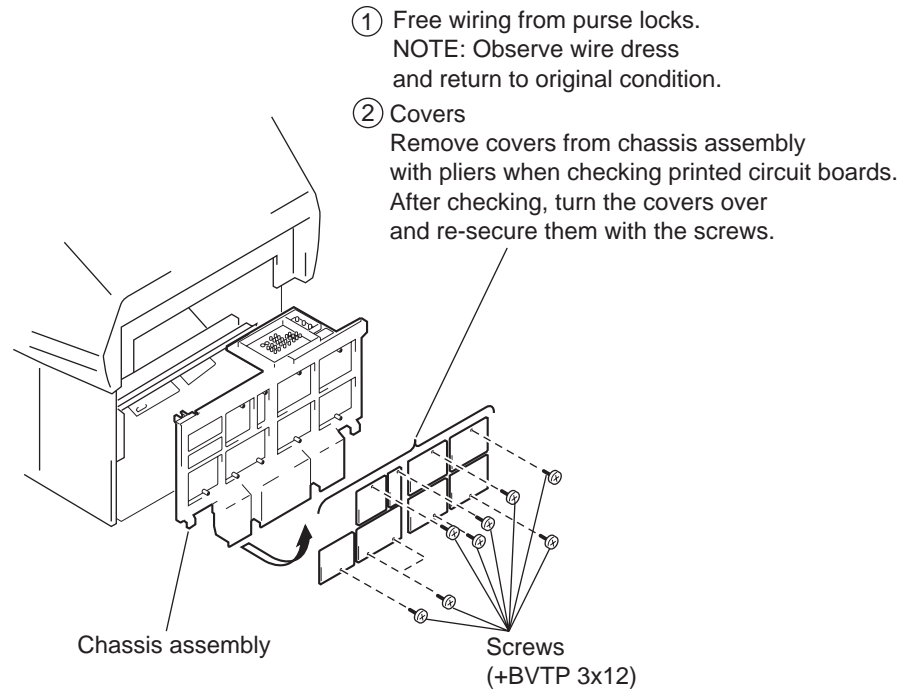

1-4. TERMINAL BOARD, P BOARD AND Q BOX ASSEMBLY REMOVAL

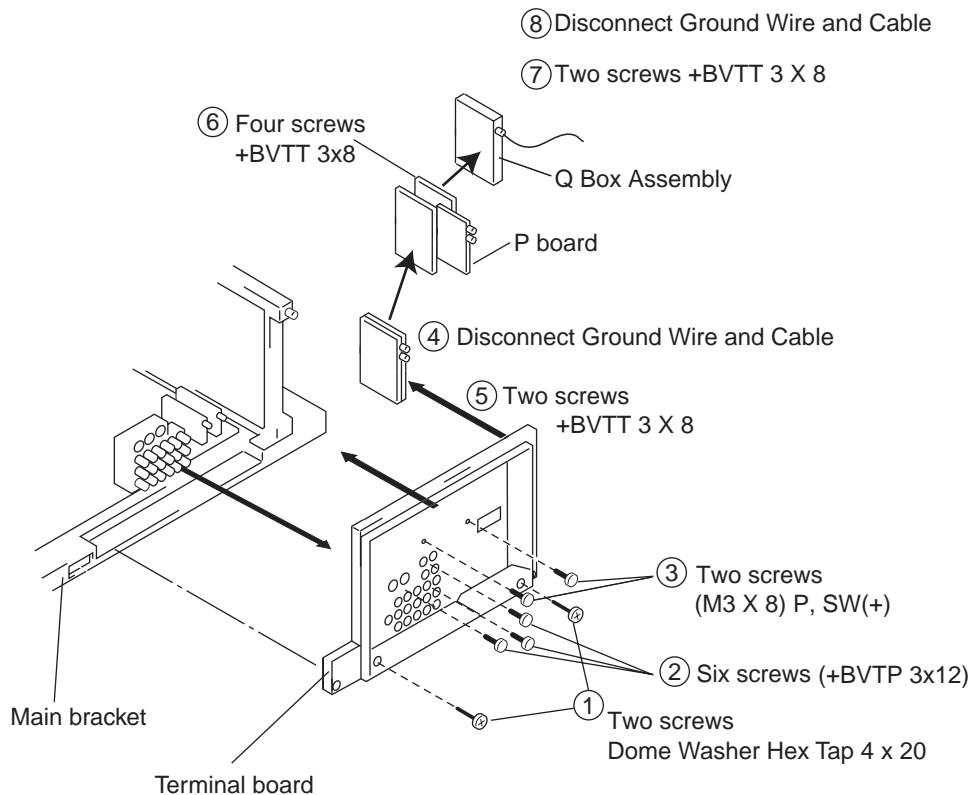

1-5. BH BOARD REMOVAL

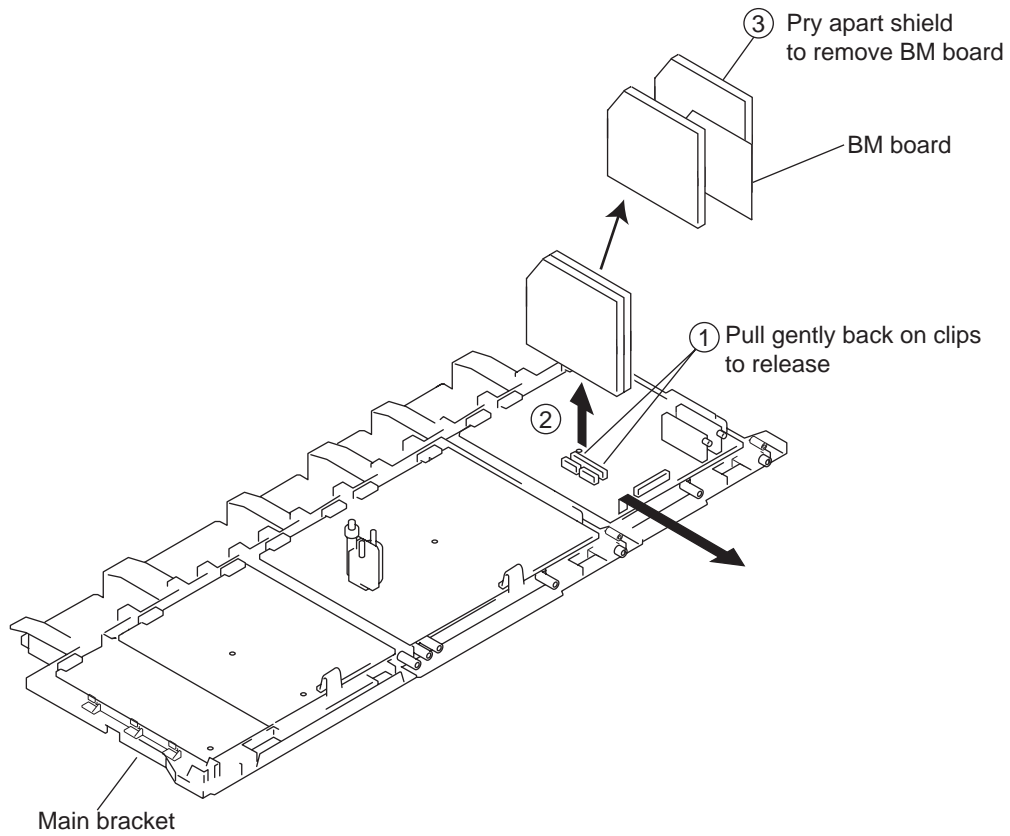

1-6. A BOARD, D BOARD, AND G BOARD REMOVAL

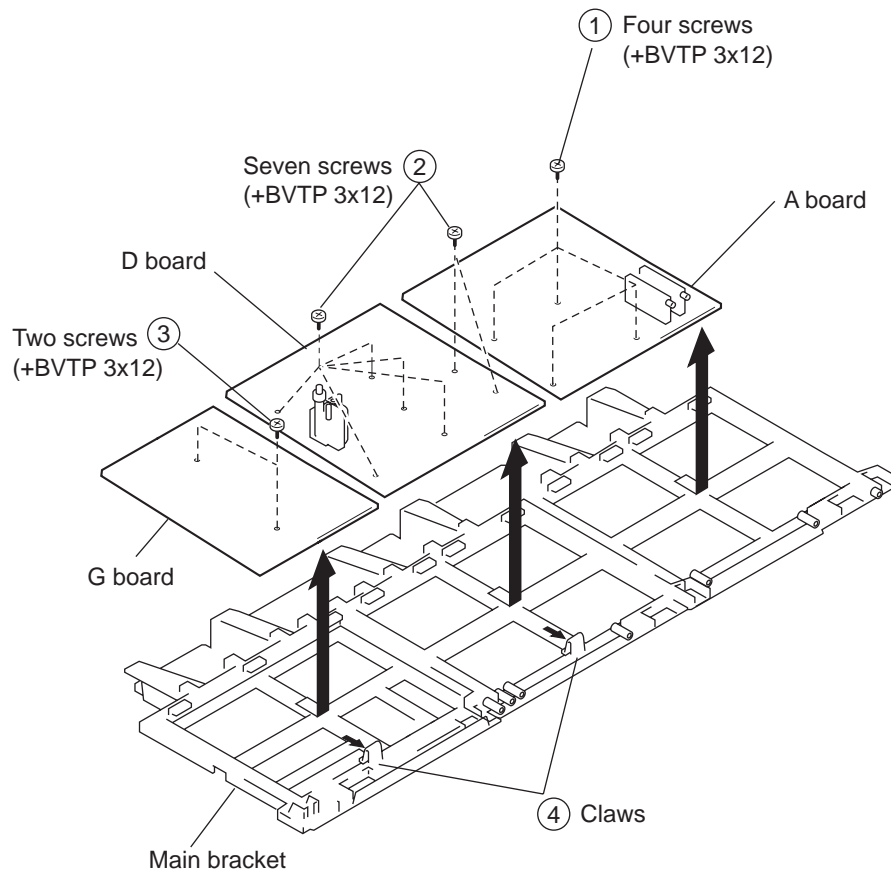

1-7. HIGH-VOLTAGE CABLE INSTALLATION AND REMOVAL

(1) Removal

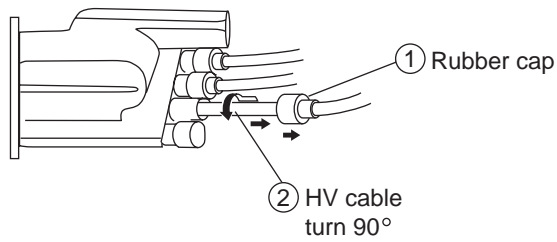

(2) Installation

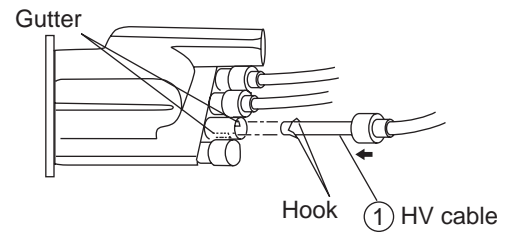

1-8. PICTURE TUBE REMOVAL

CAUTION: Removing the arrow-marked screws is strictly prohibited. If removed, it may cause liquid to spill.

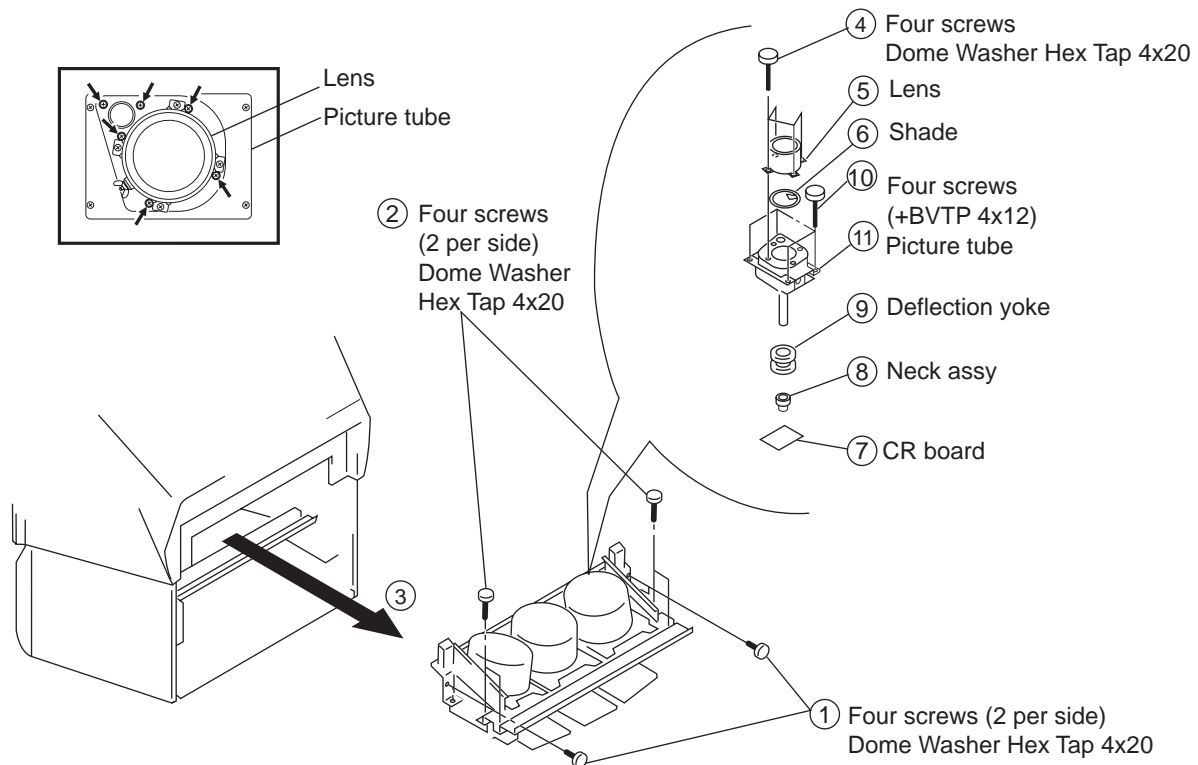

1-9. SPEAKER GRILLE, HA2 BOARD, AND HB3 BOARD REMOVAL

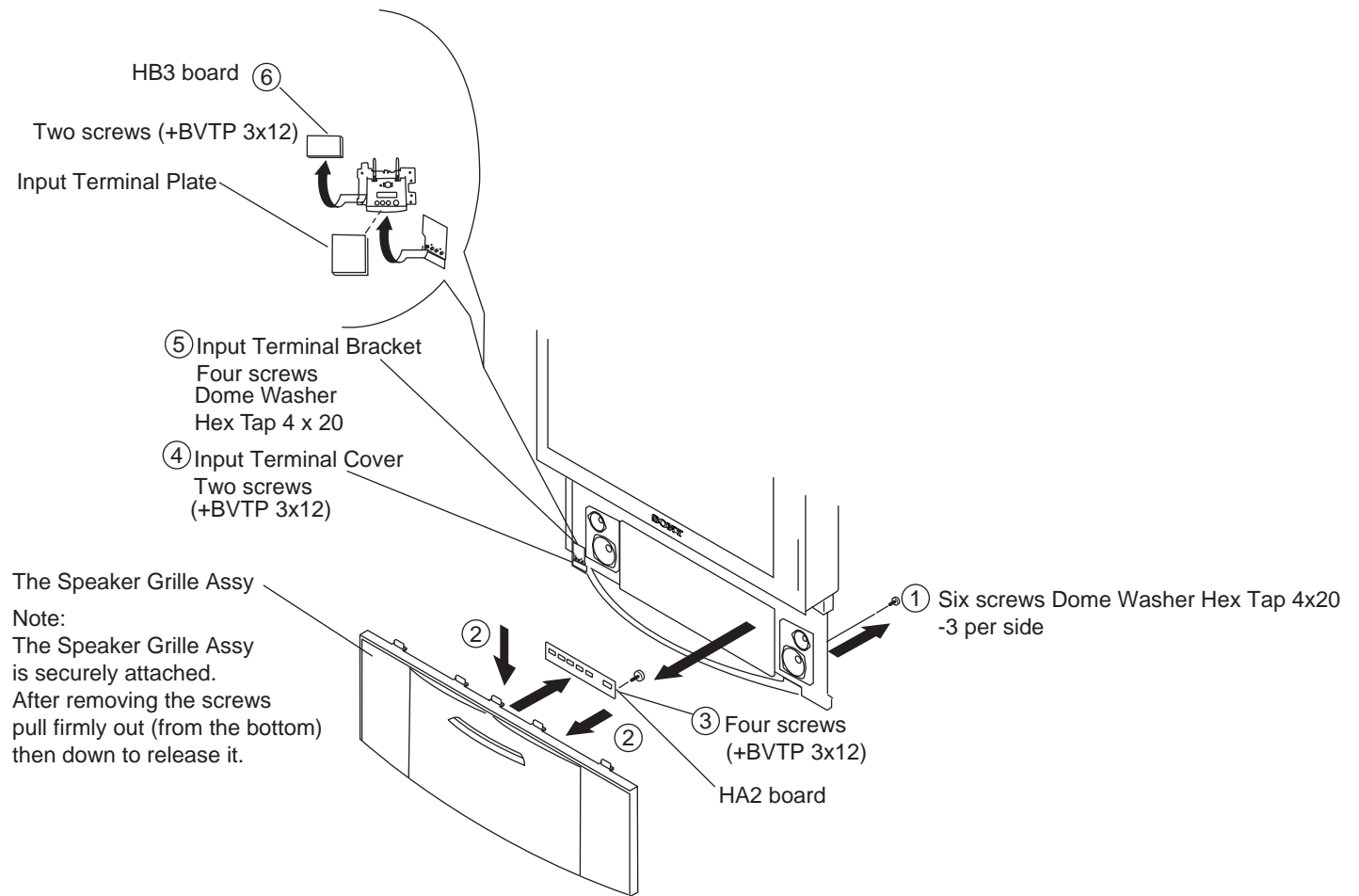

1-10.BEZNET ASSEMBLY REMOVAL

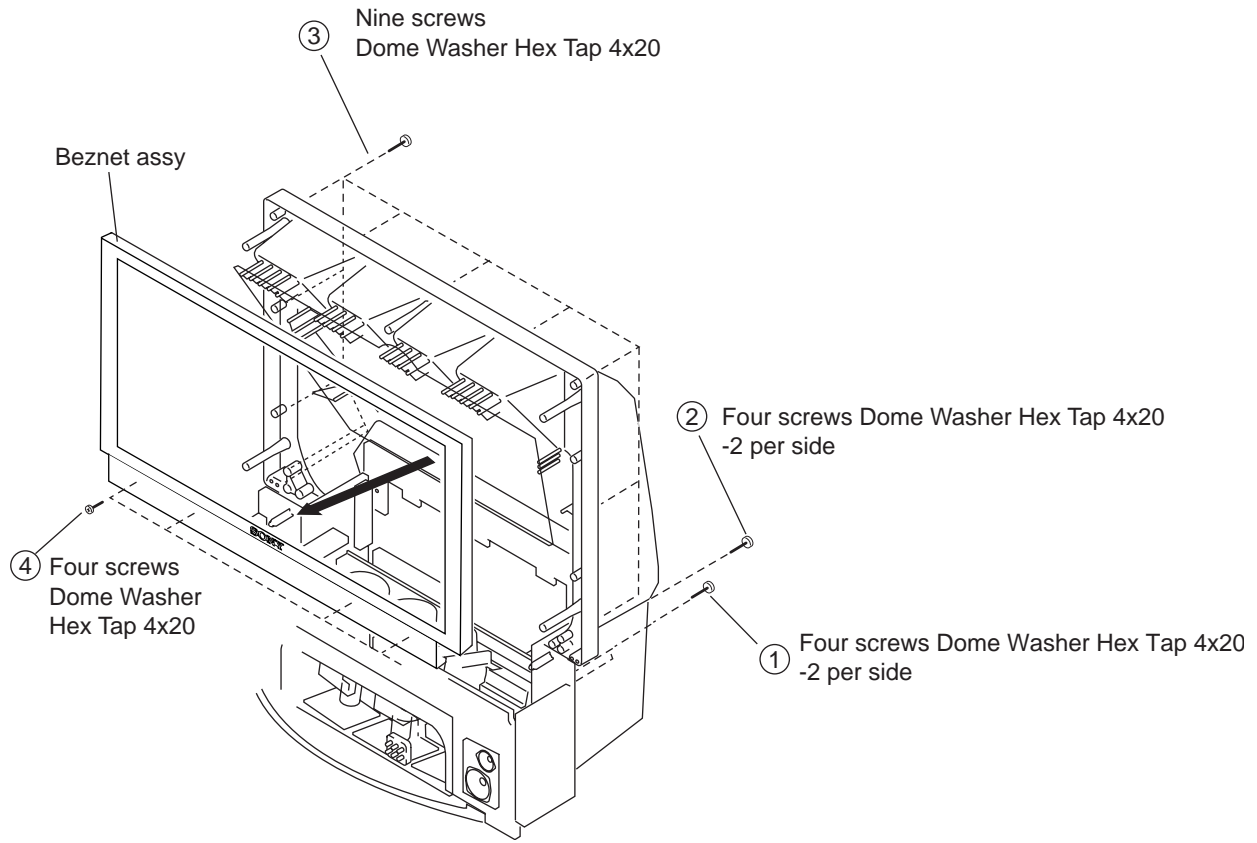

1-10-1.SCREEN TAPE METHOD

The following demonstrates the taping method when replacing the Contrast Screen or Diffusion Plates.
For Part Numbers refer to the Miscellaneous section in the back of the manual.

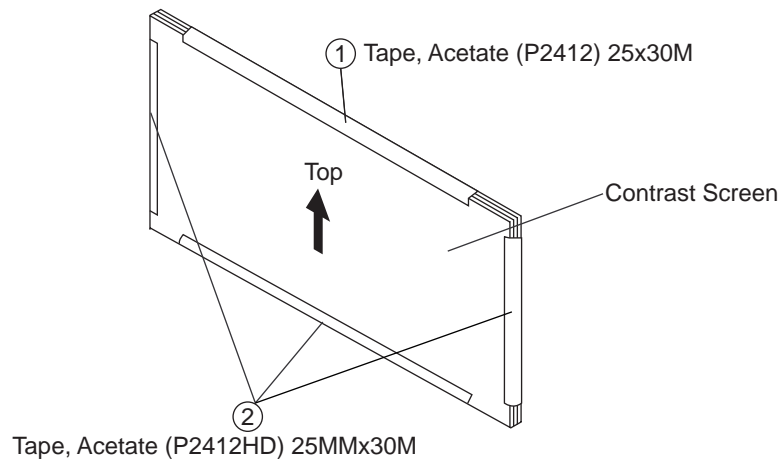

1-11.SR BOARD REMOVAL

The Screen Holder does not need to be removed in order to remove the SR boards.

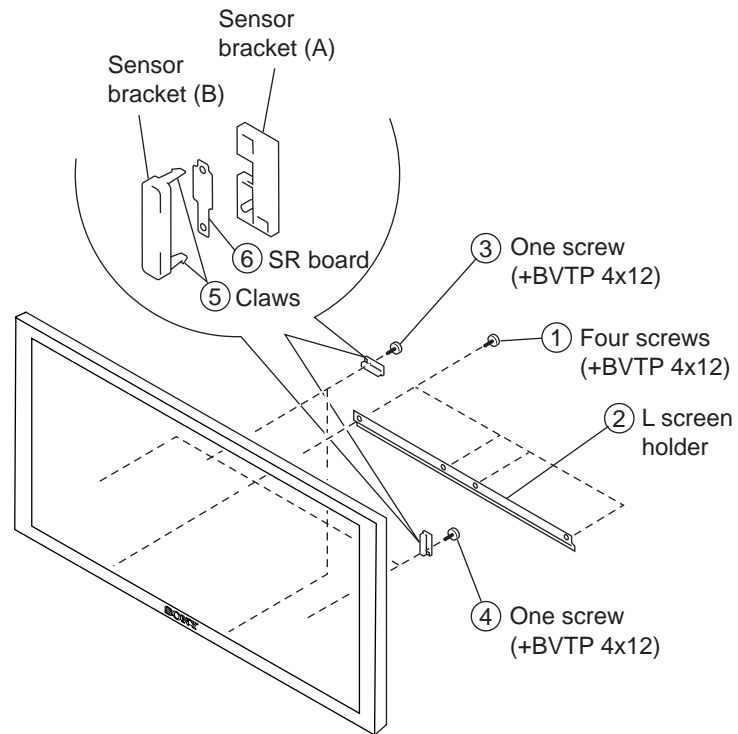

WIRE DRESSING

KDP-51/57WS655 front wire dressing

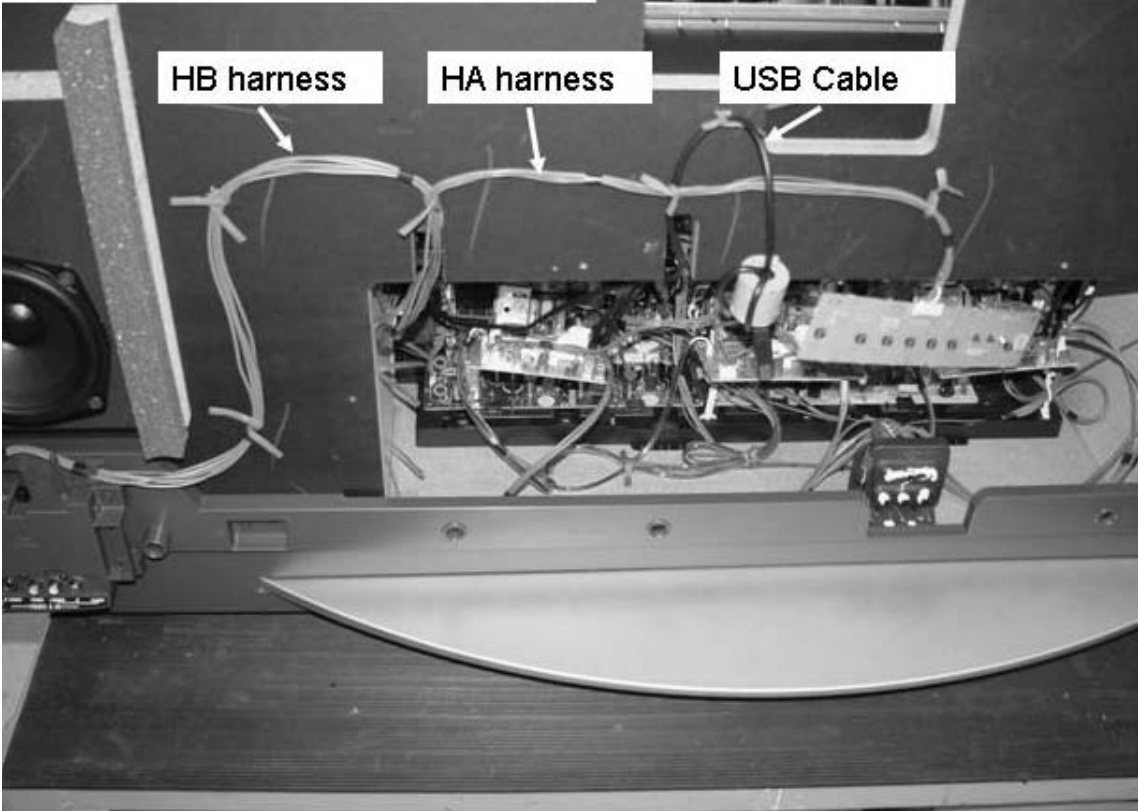

KDP-51/57WS655 front wire dressing

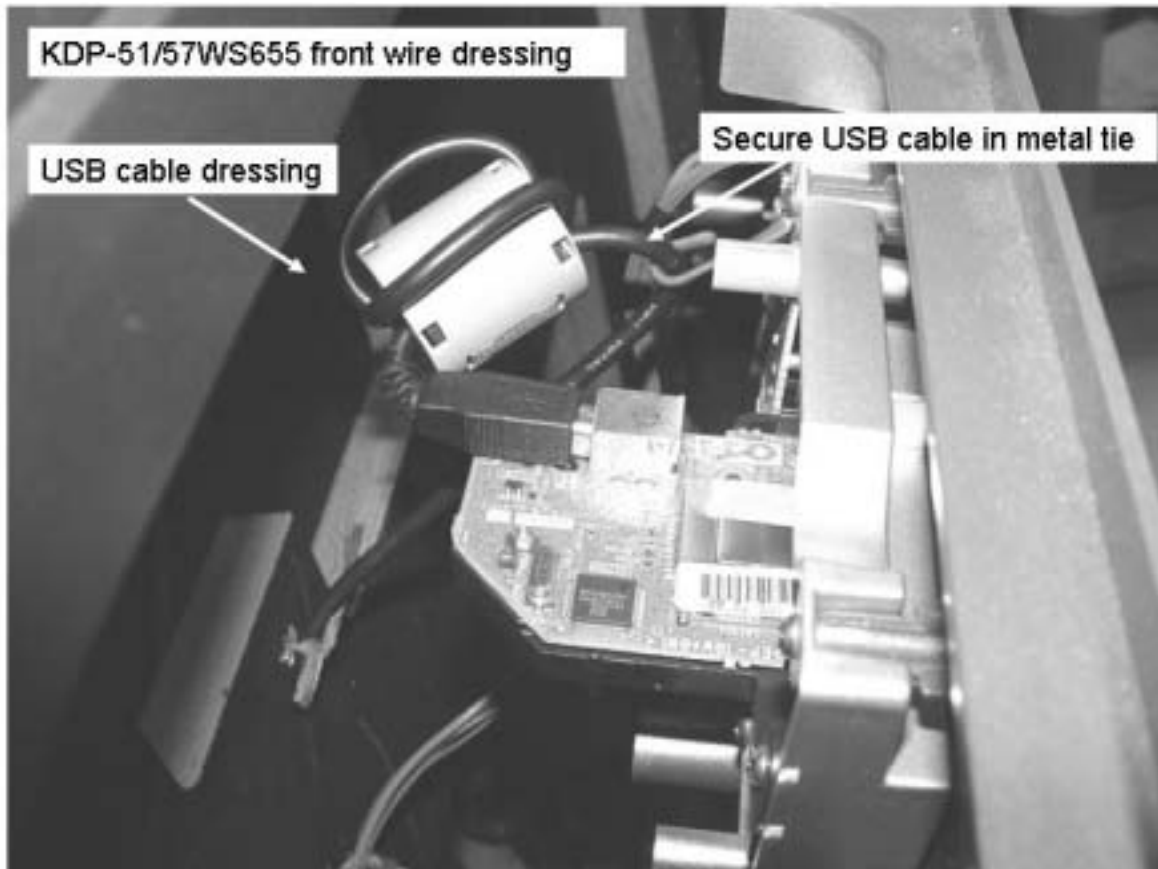

KDP-51/57WS655 G PWB wire dressing

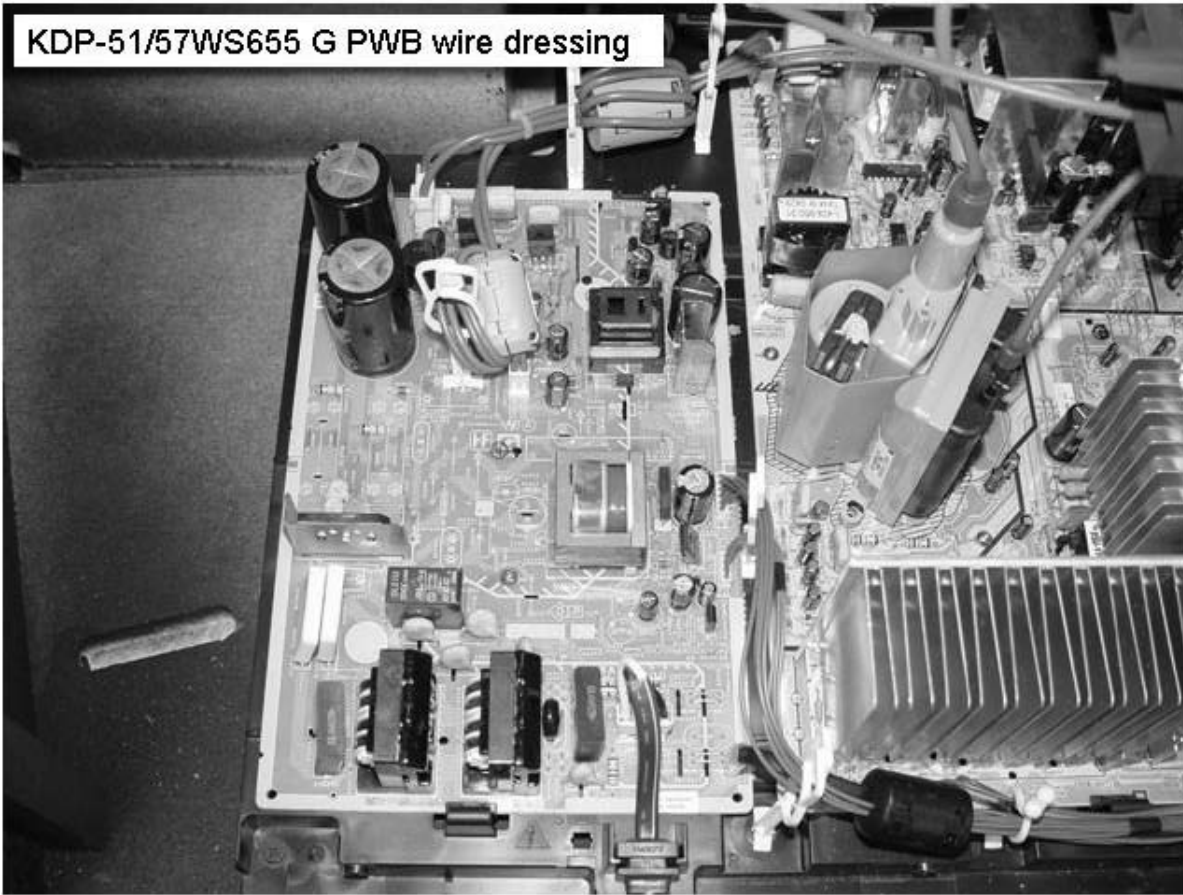

KDP-51/57WS655 D PWB wire dressing

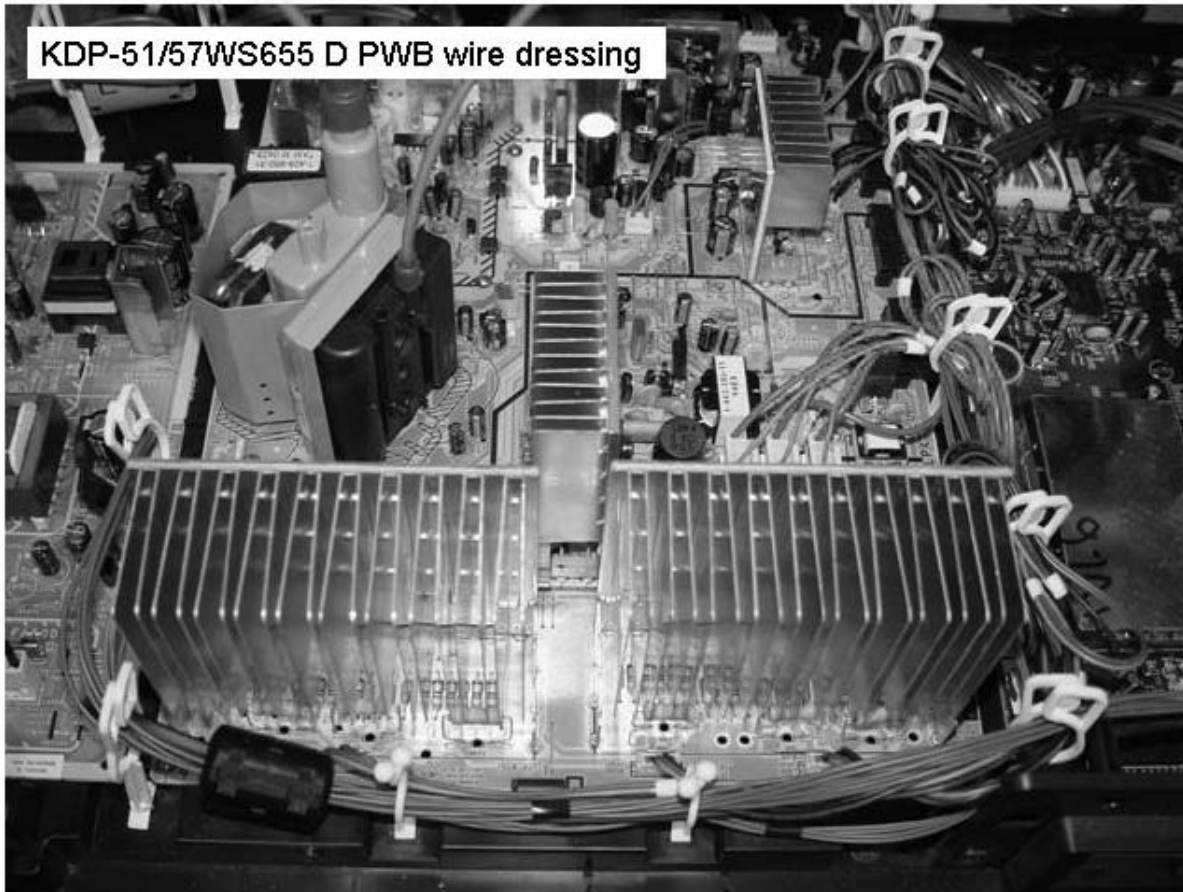

KDP-51/57WS655 A PWB wire dressing

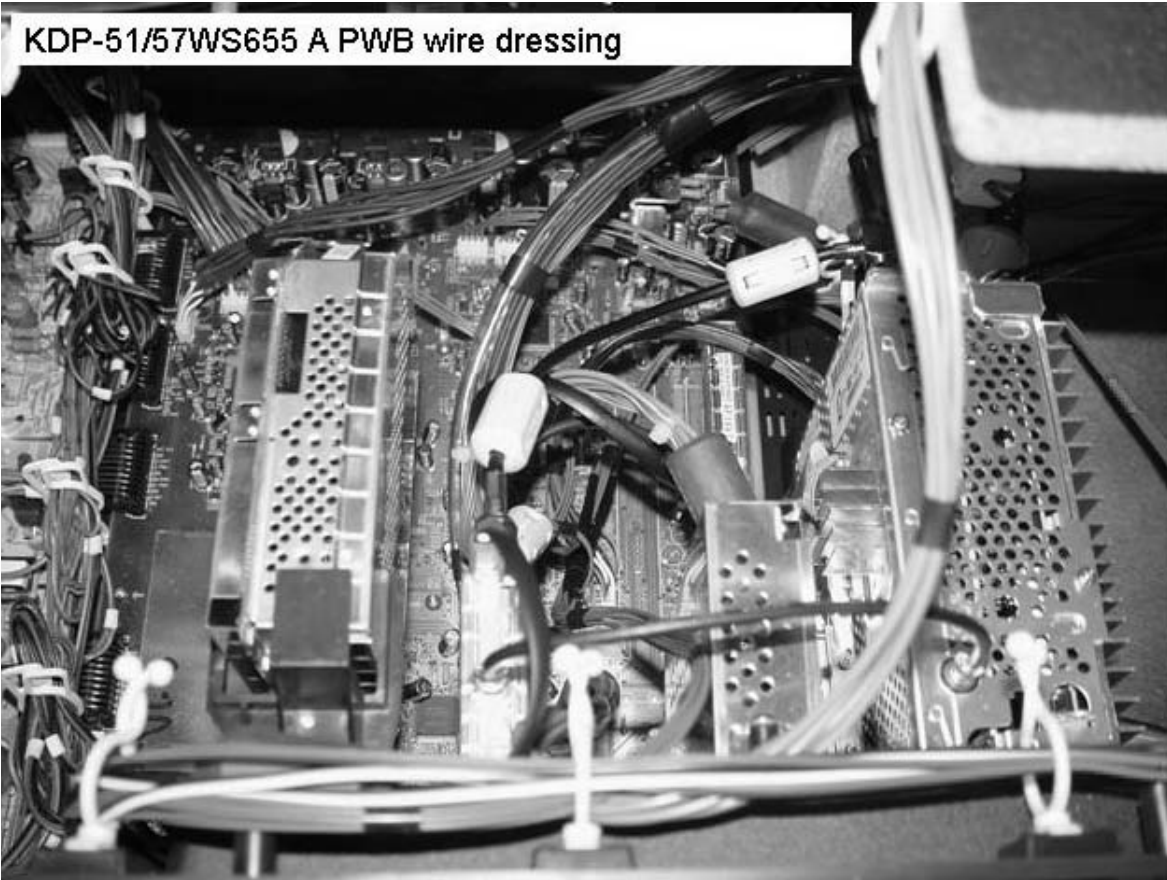

KDP-51/57WS655 chassis wire dressing



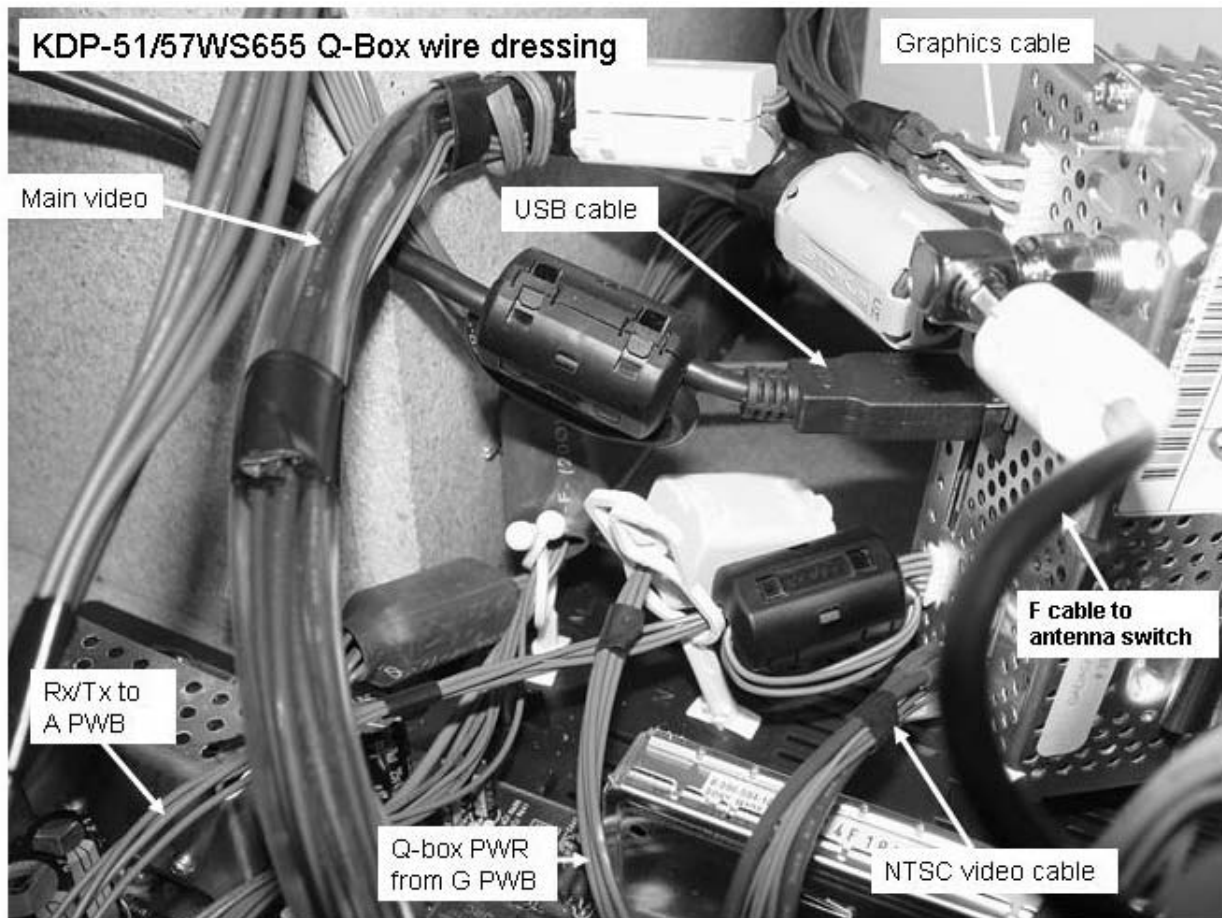
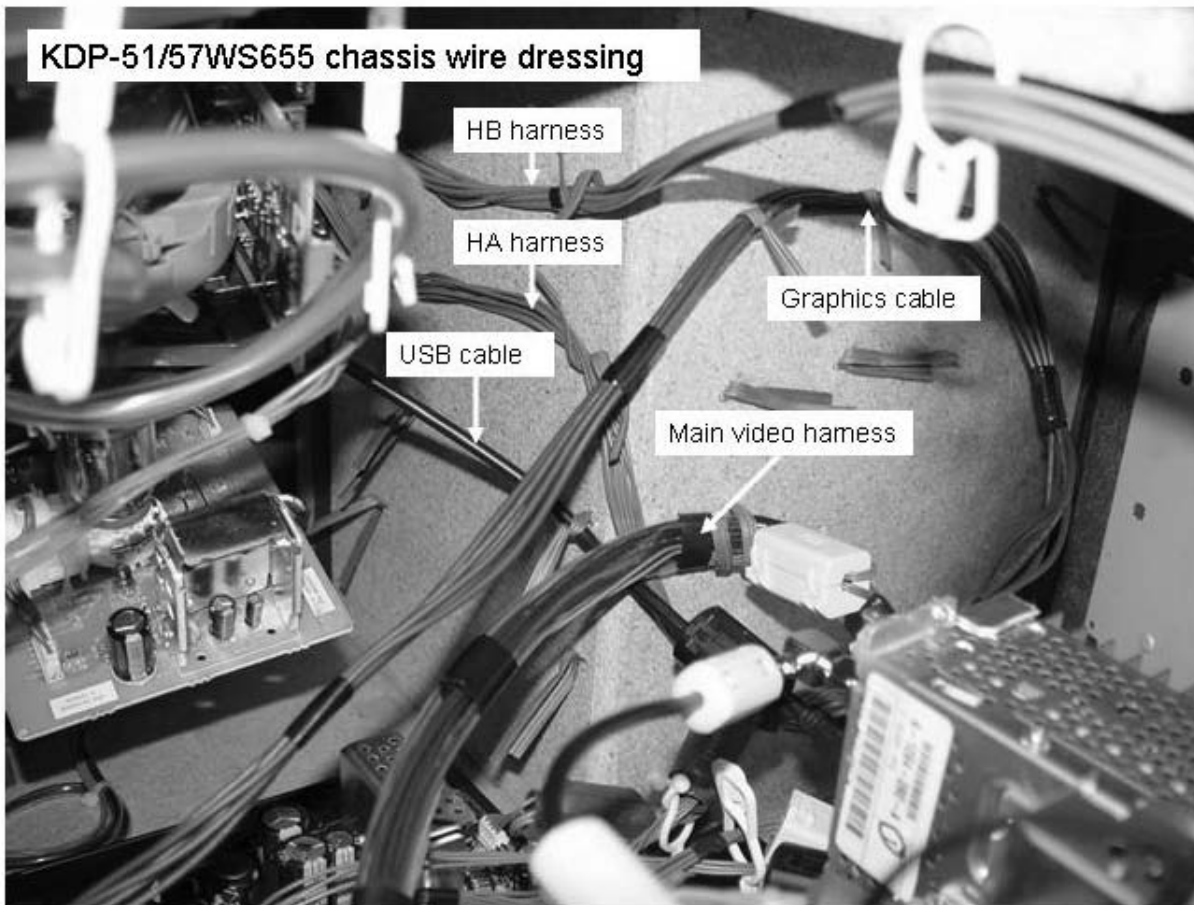

SECTION 2: SET-UP ADJUSTMENTS

2-1. SCREEN VOLTAGE ADJUSTMENT (G2) (COARSE ADJUSTMENT)

1. Receive the Monoscope signal.
2. Set BRIGHTNESS to 50% and PICTURE to minimum.
3. Turn the red VR on the focus block all the way to the left and then gradually turn it to the right until the retrace line is barely visible.
4. Gradually turn the control to the left until the retrace line disappears.

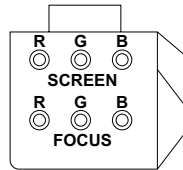

FOCUS Block

2-2. SCREEN (G2) ADJUSTMENT (FINE ADJUSTMENT)

If the jig described below is available, it is recommended that the G2 Fine Mode Adjustment be performed to set the screen controls to their optimal condition. If desired, you can build the jig illustrated below, using 3-watt resistors. Please note that if the proper voltage is not obtained with the listed resistor's values, then increase or decrease one of the values in the resistor network to obtain the correct voltage.

1. Select VIDEO-1 mode no signal applied (the screen must be black).
2. Connect the G2 JIG.
3. SW on JIG.
4. Connect an oscilloscope to the TP9101(KR), TP9201(KG) and TP9301(KB) of CR board, CG board, and CB board.
5. Adjust red, green, and blue screen voltage to $177.5 \pm 0.5V$ with screen VR on the focus block.

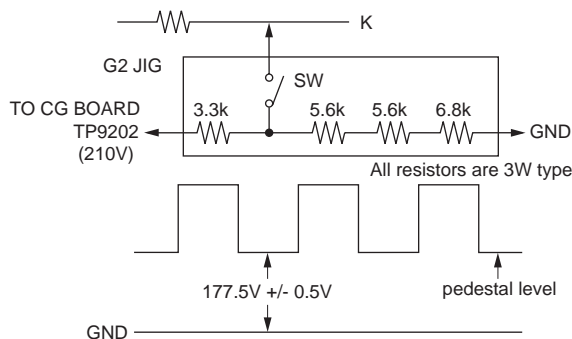

2-3. DEFLECTION YOKE TILT ADJUSTMENT

1. Connect the color bar generator monoscope pattern to Video 1 input.
2. Cover the red and blue CRT lenses with lens caps to allow only green to show (or use the method shown in the note below for turning off the CRTs individually without using lens caps).
3. Loosen the CRT's deflection yoke set screw and align the tilt of the deflection yoke so that the horizontal bars at the center of the cross-hatch pattern are parallel to the top and bottom edges of the screen.
4. After aligning the deflection yoke fasten it securely to the funnel-shaped portion (neck) of the CRT.
5. Cover the green and blue CRT lenses with lens caps to allow only green to show (or use the method shown in the note below for turning off the CRTs individually without using lens caps), then repeat steps 3 and 4 for the red CRT.
Cover the green and red CRT lenses with lens caps to allow only green to show (or use the method shown in the note below for turning off the CRTs individually without using lens caps), then repeat steps 3 and 4 for the blue CRT.

Note: If lens caps are unavailable, you can cut off the unnecessary color beams by controlling the service mode MCP-RON, GON, BON.

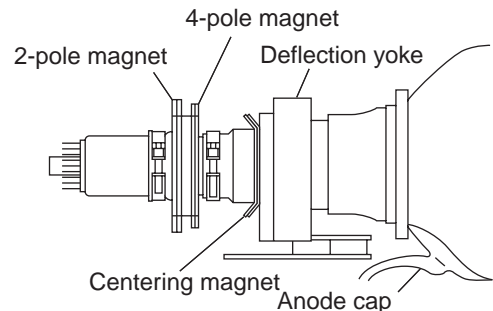

2-4. FOCUS LENS ADJUSTMENT

In this adjustment, use the remote commander while in service mode. For details on the usage of the service mode and the remote commander, please refer to section

2-10. ELECTRICAL ADJUSTMENTS BY REMOTE COMMANDER.

1. Loosen the lens screw.
2. Cover the red and blue CRT lenses with lens caps to allow only green to show (or use the method shown in the note below for turning off the CRTs individually without using lens caps).
3. Turn the green lens to adjust to the optimum focus point with the crosshatch signal.
4. Tighten the lens screw.
5. Cover the green and blue CRT lenses with the lens caps to allow only red to show (or use the method shown in the note below for turning off the CRTs individually without using lens caps).
6. Turn the red lens to adjust to the optimum focus point with the crosshatch signal.
7. Tighten the lens screw.
8. Cover the green and red CRT lenses with the lens caps to allow only blue to show (or use the method shown in the note below for turning off the CRTs individually without using lens caps).
9. Turn the blue lens to adjust to the optimum focus point with the crosshatch signal.
10. Tighten the lens screw.
11. After adjusting the items:
 2-5. FOCUS VR ADJUSTMENT,
 2-7. 2-POLE MAGNET ADJUSTMENT,
 2-8. 4-POLE MAGNET ADJUSTMENT,
 reconfirm the optimum focus point and adjust again if necessary.

* In PJE mode, every time 6 is pressed, the test signal changes to:
 "crosshatch+video signal" → "crosshatch+borderline (black)" →
 "crosshatch (black)" → "dots (black)" → "all white" → off

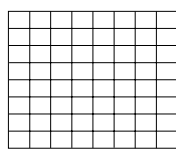

Test Signal

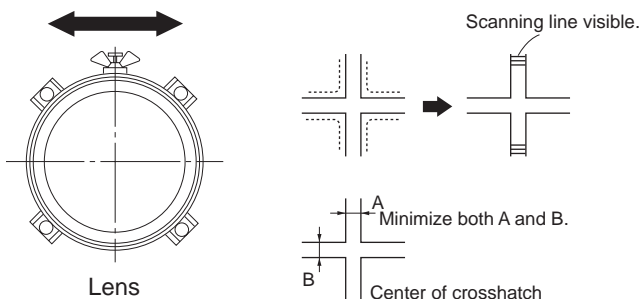

Note: If lens caps are unavailable, you can cut off the unnecessary color beams by controlling the service mode MCP-RON, GON, BON.

2-5. FOCUS VR ADJUSTMENT

1. Set generator to crosshatch.
2. Cover the red and blue CRT lenses with lens caps to allow only green to show (or use the method shown in the note below for turning off the CRTs individually without using lens caps).
3. Turn the green focus VR on the focus block to adjust to the optimum focus point with the crosshatch signal.
4. Cover the green and blue picture lenses with lens caps to allow only red to show (or use the method shown in the note below for turning off the CRTs individually without using lens caps).
5. Turn the red focus VR on the focus block to adjust to the optimum focus point with the crosshatch signal.
6. Cover the green and red picture lenses with lens caps to allow only blue to show (or use the method shown in the note below for turning off the CRTs individually without using lens caps).
7. Turn the blue focus VR on the focus block to adjust to the optimum focus point with the crosshatch signal.
8. After adjusting the items:
 2-4. FOCUS LENS ADJUSTMENT,
 2-7. 2-POLE MAGNET ADJUSTMENT,
 2-8. 4-POLE MAGNET ADJUSTMENT,
 reconfirm the optimum focus point and adjust again if necessary.

Note: If lens caps are unavailable, you can cut off the unnecessary color beams by controlling the service mode MCP-RON, GON, BON.

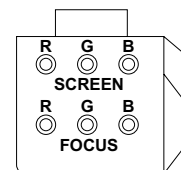

FOCUS Block

2-6. CENTERING MAGNET ADJUSTMENT

1. Set the mode to PRO.
2. Receive the monoscope signal.
3. Cover the red and blue CRT lenses with lens caps to allow only green to show (or use the method shown in the note below for turning off the CRTs individually without using lens caps).
4. Adjust the green CRT's centering magnet to put the center of the monoscope signal to the center of the screen.
5. Repeat steps 1 through 4 for the red CRT except now you will cover the green and blue CRT lenses with lens caps to allow only red to show (or use the method shown in the note below for turning off the CRTs individually without using lens caps) and you will adjust the red centering magnet.
6. Repeat steps 1 through 4 for the blue CRT except now you will cover the red and green CRT lenses with lens caps to allow only blue to show (or use the method shown in the note below for turning off the CRTs individually without using lens caps) and you will adjust the blue centering magnet.
7. After 2-Pole and 4-Pole adjustment, entering magnet adjustment needs to be confirmed. If centering magnet is re-adjusted, then 2-Pole magnet will need to be confirmed.

Note: If lens caps are unavailable, you can cut off the unnecessary color beams by controlling the service mode MCP-RON, GON, BON.

2-7. 2-POLE MAGNET ADJUSTMENT

1. Set the mode to PRO and picture to MAX.
2. Receive the 100IRE 1080i Dot signal.
3. Cover the red and blue CRT lenses with lens caps to allow only green to show (or use the method shown in the note below for turning off the CRTs individually without using lens caps).
4. Turn the focus VR on the focus block to the left (counter clockwise) and set it to overfocus to enlarge the spot.
5. Adjust the CRT's 2-pole magnet so that the small bright spot is in the center.
6. Align the focus VR on the focus block and set it for the best focus.
7. Repeat steps 1 through 6 for the red CRT covering the green and blue CRT lenses with lens caps to allow only red to show (or use the method shown in the note below for turning off the CRTs individually without using lens caps) and you will adjust the red focus control on the focus block.
8. Repeat steps 1 through 6 for the blue CRT covering the red and green CRT lenses with lens caps to allow only blue to show (or use the method shown in the note below for turning off the CRTs individually without using lens caps) and you will adjust the blue focus control on the focus block.

Note: If lens caps are unavailable, you can cut off the unnecessary color beams by controlling the service mode MCP-RON, GON, BON.

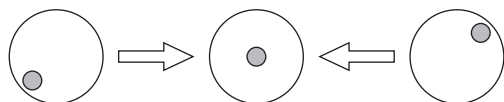

2-8. 4-POLE MAGNET ADJUSTMENT

1. Set the mode to PRO and WIDE mode = Zoom, VM:Off.
2. Receive the 100IRE 1080i Dot signal.
3. Cover the red and blue CRT lenses with lens caps to allow only green to show (or use the method shown in the note below for turning off the CRTs individually without using lens caps).
4. Turn the (green) focus VR on the focus block to the right (clockwise) and set it to under-focus to reduce the spot.
5. Adjust the 4-pole magnet so that the small spot in the center of the screen becomes round for green and red.
6. Adjust the blue spot for:
 - a. KDP-57WS655 to a round shape X:Y=1:1
 - b. KDP-51WS655 to an oval shape X:Y=1.2:1
7. Repeat steps 1 through 6 for the red CRT except now you will cover the green and blue CRT lenses with lens caps to allow only red to show (or use the method shown in the note below for turning off the CRTs individually without using lens caps) and you will adjust the red focus control on the focus block.
8. Repeat steps 1 through 6 for the blue CRT except now you will cover the red and green CRT lenses with lens caps to allow only blue to show (or use the method shown in the note below for turning off the CRTs individually without using lens caps) and you will adjust the blue focus control on the focus block.

Note: If lens caps are unavailable, you can cut off the unnecessary color beams by controlling the service mode MCP-RON, GON, BON.

Use the center dot

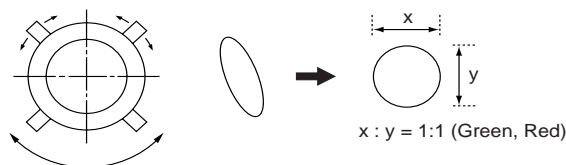

2-9. DEFOCUS ADJUSTMENT (BLUE)

Note: Adjust the blue dot to be slightly larger than red and green dots. This adjustment provides a more pleasing picture to the customer.

1. Set the mode to PRO, PICTURE : Max, COLOR TEMP : Cool.
2. Receive the 100IRE 1080i Dot signal.
3. Cover the red and green CRT lenses with lens caps to allow only blue to show (or use the method shown in the note below for turning off the CRTs individually without using lens caps).
4. Turn the blue focus VR on the focus block to the right (clockwise) until blue spot is in focus.
5. Change mode to VIVID to confirm Flare level is minimal using cross hatch signal.
6. Set the generator to an all white signal and check uniformity.

Note: If lens caps are unavailable, you can cut off the unnecessary color beams by controlling the service mode MCP-RON, GON, BON.

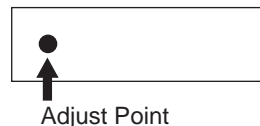

2-10.ELECTRICAL ADJUSTMENTS BY REMOTE COMMANDER

All of the circuit adjustments can be made by using the remote commander (RM-Y915).

Note: The following test equipment is required:

1. Pattern Generator (with component outputs)
2. Frequency counter
3. Digital multimeter
4. Audio oscillator

2-10-1.METHOD OF ENTERING THE SERVICE ADJUSTMENT MODE

SERVICE MODE PROCEDURE

1. TV must be in Standby mode. (Power off)
2. Press "DISPLAY", "5", "VOL +", then "POWER" on the remote commander to access service mode.
(Press each button within 1 second of pressing the previous button.)

SERVICE MODE ADJUSTMENT

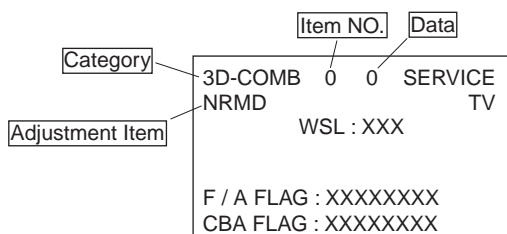

3. The screen displays the item being adjusted within that category.
 4. Press "1" or "4" on the remote commander to select the adjustment item
 5. Press "3" or "6" on the remote commander to change the data
 6. Press "2" or "5" on the remote commander to select the adjustment category
- Every time you press "2" (Category up), service mode changes in the order shown below:

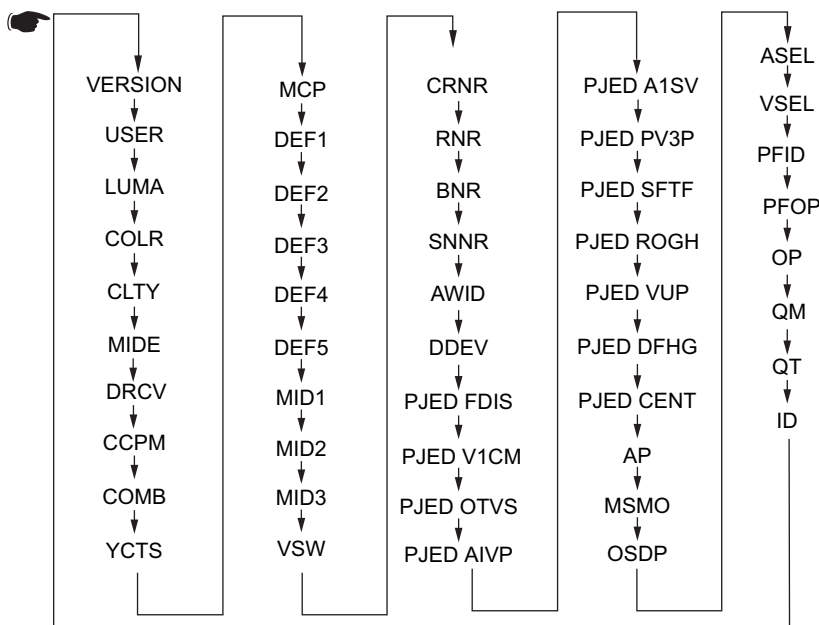

7. If you want to go back to the most recently saved value, press "0" then "ENTER" to read the memory.
8. Press "MUTING" then "ENTER" to write the new adjustment data into memory.
9. Turn power off when you want to exit the service mode.

Note: Press "8" then "ENTER" on the remote commander to restore the factory settings for user controls and channel memories (this will also turn the set off and then on to exit service mode).

2-10-2.MEMORY WRITE CONFIRMATION METHOD

1. After adjustment, turn the power off with the remote commander.
2. Press "DISPLAY", "5", "VOL +", then "POWER" on the remote commander to access service mode.
3. Cycle through the adjusted items again and confirm that the adjustments were saved.

2-10-3.ADJUSTING BUTTONS AND INDICATOR

Note: When the PJE mode (which displays an internally generated signal) is activated, several buttons on the remote commander will have different functions than the ones listed below. Therefore, when in the PJE mode, refer to section 2-12-3 for button functions.

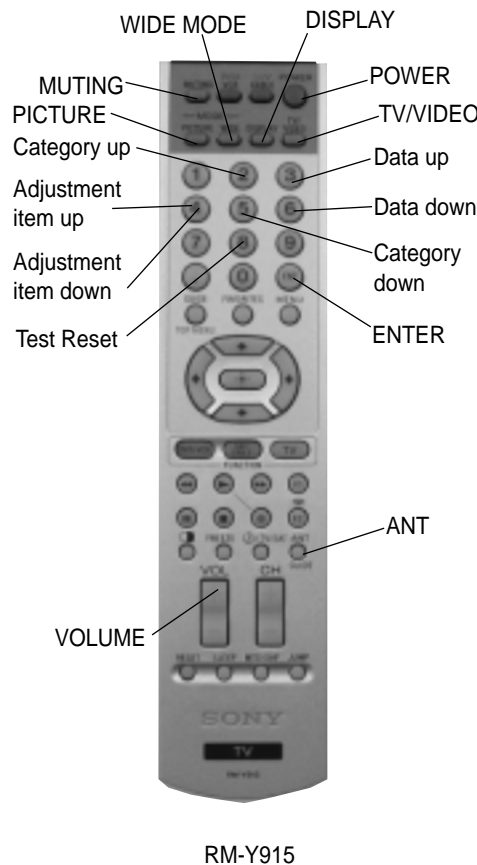

2-11.ADJUSTABLE SERVICE DATA LISTS

Only the Adjustable registers are shown in this data list.

A complete set of the AX1X Digital service data, Fixed and Adjustable, can be downloaded at:

http://www-ec.sdp.sel.sony.com/padics/Model_Data_List.htm

Only Sony authorized Service Technician can access this site.

CATEGORY	#	ITEM	DESCRIPTION	CONDITION	SERVICE DATA (dec)			
					51WS655 (U/C)	57WS655 (U/C)	MIN	MAX
OP	5	OSDH	OSD Horizontal Position	(common)	21	21	0	255
	6	OSDF	OSD Favorite Position	(common)	28	28	0	63

CATEGORY	#	ITEM	DESCRIPTION	CONDITION	SERVICE DATA (dec)			
					51WS655 (U/C)	57WS655 (U/C)	MIN	MAX
COLR	2	RDRV	Red Drive Gain	COMMON	38	38	0	63
	4	BDRV	Blue Drive Gain	COMMON	23	23	0	63
	5	RCUT	Red cut-off	COMMON	23	23	0	63
	7	BCUT	Blue cut-off	COMMON	27	27	0	63
	8	SBRT	Sub Bright	COMMON	23	23	0	63
CCPM	1	YLEV	Y Level	RF - 60HZ	205	205	0	255
				CV - 60HZ	190	190	0	255
	2	CLEV	C Level	RF - 60HZ	110	110	0	255
				CV - 60HZ	103	103	0	255
	3	SHUE	Sub Hue	RF - 60HZ	7	7	0	15
				CV - 60HZ	7	7	0	15
YCTS (CXA2103)	2	SCON	Sub Contrast	RF	9	9	0	15
				OTHER	6	6	0	15
	3	SCOL	Sub Color	RF	6	6	0	15
				OTHER	5	5	0	15
	4	SHUE	Sub Hue	RF	3	3	0	15
				OTHER	5	5	0	15
MCP	9	CBOF	Cb Offset	DRC - RF/BS/CV/YC	31	31	0	63
				DRC - RF/BS/CV/YC	30	30	0	63
DEF1	0	VPOS	Vertical Position	COMMON	25	25	0	63
	1	VSIZ	Vertical Size	COMMON	31	31	0	63
DEF2	2	HSIZ	Horizontal Size	WIDEZOOM	24	24	0	63
				OTHER	24	24	0	63
	3	SLIN	S Linearity	WIDEZOOM	7	7	0	15
				OTHER	7	7	0	15

CATEGORY	#	ITEM	DESCRIPTION	CONDITION	SERVICE DATA (dec)			
					51WS655 (U/C)	57WS655 (U/C)	MIN	MAX
PJE	93	R0GH	Ratio Offset S0 G H	(common)	0	0	-128	127
	94	R0RH	Ratio Offset S0 R H	(common)	0	0	-128	127
	95	R0BH	Ratio Offset S0 B H	(common)	0	0	-128	127
	96	R1GH	Ratio Offset S1 G H	(common)	0	0	-128	127
	97	R1RH	Ratio Offset S1 R H	(common)	0	0	-128	127
	98	R1BH	Ratio Offset S1 B H	(common)	0	0	-128	127
	99	R2GH	Ratio Offset S2 G H	(common)	0	0	-128	127
	100	R2RH	Ratio Offset S2 R H	(common)	0	0	-128	127
	101	R2BH	Ratio Offset S2 B H	(common)	0	0	-128	127
	102	R3GH	Ratio Offset S3 G H	(common)	0	0	-128	127
	103	R3RH	Ratio Offset S3 R H	(common)	0	0	-128	127
	104	R3BH	Ratio Offset S3 B H	(common)	0	0	-128	127
	105	R1GV	Ratio Offset S1 G V	(common)	0	0	-128	127
	106	R1RV	Ratio Offset S1 R V	(common)	0	0	-128	127
	107	R1BV	Ratio Offset S1 B V	(common)	0	0	-128	127
	108	R2GV	Ratio Offset S2 G V	(common)	0	0	-128	127
	109	R2RV	Ratio Offset S2 R V	(common)	0	0	-128	127
	110	R2BV	Ratio Offset S2 B V	(common)	0	0	-128	127
	111	PTRH	Pattern Offset Top R H	(common)	0	0	-128	127
	112	PTBH	Pattern Offset Top B H	(common)	0	0	-128	127
	113	PLRH	Pattern Offset Left R H	(common)	0	0	-128	127
	114	PLBH	Pattern Offset Left B H	(common)	0	0	-128	127
	115	PLRV	Pattern Offset Left R V	(common)	0	0	-128	127
	116	PLBV	Pattern Offset Left B V	(common)	0	0	-128	127
	117	PRRH	Pattern Offset Right R H	(common)	0	0	-128	127
	118	PRBH	Pattern Offset Right B H	(common)	0	0	-128	127
	119	PRGV	Pattern Offset Right G V	(common)	0	0	-128	127
	120	PRRV	Pattern Offset Right R V	(common)	0	0	-128	127
	121	PRBV	Pattern Offset Right B V	(common)	0	0	-128	127
	122	PBGH	Pattern Offset Bottom G H	(common)	0	0	-128	127
	123	PBRH	Pattern Offset Bottom R H	(common)	0	0	-128	127
	124	PBBH	Pattern Offset Bottom B H	(common)	0	0	-128	127
	125	ERR	Auto Regi Error Code	(common)	0	0	0	255
	130	VUP	Auto Regi V Upper Pattern Position	(common)	50	50	0	2047
	131	VMID	Auto Regi V Middle Pattern Position	(common)	495	495	0	2047
	132	VLOW	Auto Regi V Lower Pattern Position	(common)	947	947	0	2047
	133	HLE	Auto Regi H Left Pattern Position	(common)	181	181	0	2047
	134	HMID	Auto Regi H Middle Pattern Position	(common)	853	853	0	2047
	135	HRIT	Auto Regi H Right Pattern Position	(common)	1522	1522	0	2047

CATEGORY	#	ITEM	DESCRIPTION	CONDITION	SERVICE DATA (dec)			
					51WS655 (U/C)	57WS655 (U/C)	MIN	MAX
PJE	141	CENT	R H Cent	Full / Normal	40	40	-512	511
				Zoom	40	40	-512	511
				WideZoom	40	40	-512	511
				1080i Full / Normal	40	40	-512	511
				1080i Zoom	40	40	-512	511
				1080i WideZoom	40	40	-512	511
			R V Cent	Full / Normal	20	20	-512	511
				Zoom	20	20	-512	511
				WideZoom	20	20	-512	511
				1080i Full / Normal	20	20	-512	511
				1080i Zoom	20	20	-512	511
				1080i WideZoom	20	20	-512	511
			G H Cent	Full / Normal	40	40	-512	511
				Zoom	40	40	-512	511
				WideZoom	40	40	-512	511
				1080i Full / Normal	40	40	-512	511
				1080i Zoom	40	40	-512	511
				1080i WideZoom	40	40	-512	511
			G V Cent	Full / Normal	20	20	-512	511
				Zoom	20	20	-512	511
				WideZoom	20	20	-512	511
				1080i Full	20	20	-512	511
				1080i Zoom	20	20	-512	511
				1080i WideZoom	20	20	-512	511

CATEGORY	#	ITEM	DESCRIPTION	CONDITION	SERVICE DATA (dec)			
					51WS655 (U/C)	57WS655 (U/C)	MIN	MAX
PJE	141	CENT	B H Cent	Full / Normal	40	40	-512	511
				Zoom	40	40	-512	511
				WideZoom	40	40	-512	511
				1080i Full / Normal	40	40	-512	511
				1080i Zoom	40	40	-512	511
				1080i WideZoom	40	40	-512	511
			B V Cent	Full / Normal	20	20	-512	511
				Zoom	20	20	-512	511
				WideZoom	20	20	-512	511
				1080i Full / Normal	20	20	-512	511
				1080i Zoom	20	20	-512	511
				1080i WideZoom	20	20	-512	511
	142	SIZE	R H Size	Full / Normal	-120	-120	-512	511
				Zoom	-120	-120	-512	511
				WideZoom	-120	-120	-512	511
				1080i Full / Normal	-120	-120	-512	511
				1080i Zoom	-120	-120	-512	511
				1080i WideZoom	-120	-120	-512	511
			R V Size	Full / Normal	-80	-80	-512	511
				Zoom	-80	-80	-512	511
				WideZoom	-80	-80	-512	511
				1080i Full / Normal	-80	-80	-512	511
				1080i Zoom	-80	-80	-512	511
				1080i WideZoom	-80	-80	-512	511

CATEGORY	#	ITEM	DESCRIPTION	CONDITION	SERVICE DATA (dec)			
					51WS655 (U/C)	57WS655 (U/C)	MIN	MAX
PJE	142	SIZE	G H Size	Full / Normal	-120	-120	-512	511
				Zoom	-120	-120	-512	511
				WideZoom	-120	-120	-512	511
				1080i Full / Normal	-120	-120	-512	511
				1080i Zoom	-120	-120	-512	511
				1080i WideZoom	-120	-120	-512	511
			G V Size	Full / Normal	-80	-80	-512	511
				Zoom	-80	-80	-512	511
				WideZoom	-80	-80	-512	511
				1080i Full / Normal	-80	-80	-512	511
				1080i Zoom	-80	-80	-512	511
				1080i WideZoom	-80	-80	-512	511
			B H Size	Full / Normal	-120	-120	-512	511
				Zoom	-120	-120	-512	511
				WideZoom	-120	-120	-512	511
				1080i Full / Normal	-120	-120	-512	511
				1080i Zoom	-120	-120	-512	511
				1080i WideZoom	-120	-120	-512	511
			B V Size	Full / Normal	-80	-80	-512	511
				Zoom	-80	-80	-512	511
				WideZoom	-80	-80	-512	511
				1080i Full / Normal	-80	-80	-512	511
				1080i Zoom	-80	-80	-512	511
				1080i WideZoom	-80	-80	-512	511

CATEGORY	#	ITEM	DESCRIPTION	CONDITION	SERVICE DATA (dec)			
					51WS655 (U/C)	57WS655 (U/C)	MIN	MAX
PJE	143	LIN	R H Lin	Full / Normal	300	300	-512	511
				Zoom	300	300	-512	511
				WideZoom	300	300	-512	511
				1080i Full / Normal	300	300	-512	511
				1080i Zoom	300	300	-512	511
				1080i WideZoom	300	300	-512	511
			R V Lin	Full / Normal	0	0	-512	511
				Zoom	0	0	-512	511
				WideZoom	0	0	-512	511
				1080i Full / Normal	0	0	-512	511
				1080i Zoom	0	0	-512	511
				1080i WideZoom	0	0	-512	511
			G H Lin	Full / Normal	0	0	-512	511
				Zoom	0	0	-512	511
				WideZoom	0	0	-512	511
				1080i Full / Normal	0	0	-512	511
				1080i Zoom	0	0	-512	511
				1080i WideZoom	0	0	-512	511
			G V Lin	Full / Normal	0	0	-512	511
				Zoom	0	0	-512	511
				WideZoom	0	0	-512	511
				1080i Full / Normal	0	0	-512	511
				1080i Zoom	0	0	-512	511
				1080i WideZoom	0	0	-512	511

CATEGORY	#	ITEM	DESCRIPTION	CONDITION	SERVICE DATA (dec)			
					51WS655 (U/C)	57WS655 (U/C)	MIN	MAX
PJE	143	LIN	B H Lin	Full / Normal	-300	-300	-512	511
				Zoom	-300	-300	-512	511
				WideZoom	-300	-300	-512	511
				1080i Full / Normal	-300	-300	-512	511
				1080i Zoom	-300	-300	-512	511
				1080i WideZoom	-300	-300	-512	511
			B V Lin	Full / Normal	0	0	-512	511
				Zoom	0	0	-512	511
				WideZoom	0	0	-512	511
				1080i Full / Normal	0	0	-512	511
				1080i Zoom	0	0	-512	511
				1080i WideZoom	0	0	-512	511
	144	SKEW	R H Skew	Full / Normal	0	0	-512	511
				Zoom	0	0	-512	511
				WideZoom	0	0	-512	511
				1080i Full	0	0	-512	511
				1080i Zoom	0	0	-512	511
				1080i WideZoom	0	0	-512	511
			R V Skew	Full / Normal	0	0	-512	511
				Zoom	0	0	-512	511
				WideZoom	0	0	-512	511
				1080i Full / Normal	0	0	-512	511
				1080i Zoom	0	0	-512	511
				1080i WideZoom	0	0	-512	511

CATEGORY	#	ITEM	DESCRIPTION	CONDITION	SERVICE DATA (dec)			
					51WS655 (U/C)	57WS655 (U/C)	MIN	MAX
PJE	144	SKEW	G H Skew	Full / Normal	0	0	-512	511
				Zoom	0	0	-512	511
				WideZoom	0	0	-512	511
				1080i Full / Normal	0	0	-512	511
				1080i Zoom	0	0	-512	511
				1080i WideZoom	0	0	-512	511
			G V Skew	Full / Normal	0	0	-512	511
				Zoom	0	0	-512	511
				WideZoom	0	0	-512	511
				1080i Full / Normal	0	0	-512	511
				1080i Zoom	0	0	-512	511
				1080i WideZoom	0	0	-512	511
			B H Skew	Full / Normal	0	0	-512	511
				Zoom	0	0	-512	511
				WideZoom	0	0	-512	511
				1080i Full / Normal	0	0	-512	511
				1080i Zoom	0	0	-512	511
				1080i WideZoom	0	0	-512	511
			B V Skew	Full / Normal	0	0	-512	511
				Zoom	0	0	-512	511
				WideZoom	0	0	-512	511
				1080i Full / Normal	0	0	-512	511
				1080i Zoom	0	0	-512	511
				1080i WideZoom	0	0	-512	511

CATEGORY	#	ITEM	DESCRIPTION	CONDITION	SERVICE DATA (dec)			
					51WS655 (U/C)	57WS655 (U/C)	MIN	MAX
PJE	145	BOW	R H Bow	Full / Normal	0	0	-512	511
				Zoom	0	0	-512	511
				WideZoom	0	0	-512	511
				1080i Full / Normal	0	0	-512	511
				1080i Zoom	0	0	-512	511
				1080i WideZoom	0	0	-512	511
			R V Bow	Full / Normal	0	0	-512	511
				Zoom	0	0	-512	511
				WideZoom	0	0	-512	511
				1080i Full / Normal	0	0	-512	511
				1080i Zoom	0	0	-512	511
				1080i WideZoom	0	0	-512	511
			G H Bow	Full / Normal	0	0	-512	511
				Zoom	0	0	-512	511
				WideZoom	0	0	-512	511
				1080i Full / Normal	0	0	-512	511
				1080i Zoom	0	0	-512	511
				1080i WideZoom	0	0	-512	511
			G V Bow	Full / Normal	0	0	-512	511
				Zoom	0	0	-512	511
				WideZoom	0	0	-512	511
				1080i Full / Normal	0	0	-512	511
				1080i Zoom	0	0	-512	511
				1080i WideZoom	0	0	-512	511

CATEGORY	#	ITEM	DESCRIPTION	CONDITION	SERVICE DATA (dec)			
					51WS655 (U/C)	57WS655 (U/C)	MIN	MAX
PJE	145	BOW	B H Bow	Full / Normal	0	0	-512	511
				Zoom	0	0	-512	511
				WideZoom	0	0	-512	511
				1080i Full / Normal	0	0	-512	511
				1080i Zoom	0	0	-512	511
				1080i WideZoom	0	0	-512	511
		B V Bow	Full / Normal	0	0	-512	511	
			Zoom	0	0	-512	511	
			WideZoom	0	0	-512	511	
			1080i Full / Normal	0	0	-512	511	
			1080i Zoom	0	0	-512	511	
			1080i WideZoom	0	0	-512	511	
	146	KEY	R H Key	Full / Normal	0	0	-512	511
				Zoom	0	0	-512	511
				WideZoom	0	0	-512	511
				1080i Full / Normal	0	0	-512	511
				1080i Zoom	0	0	-512	511
				1080i WideZoom	0	0	-512	511
		R V Key	Full / Normal	130	130	-512	511	
			Zoom	130	130	-512	511	
			WideZoom	130	130	-512	511	
			1080i Full / Normal	130	130	-512	511	
			1080i Zoom	130	130	-512	511	
			1080i WideZoom	130	130	-512	511	

CATEGORY	#	ITEM	DESCRIPTION	CONDITION	SERVICE DATA (dec)			
					51WS655 (U/C)	57WS655 (U/C)	MIN	MAX
PJE	146	KEY	G H Key	Full / Normal	0	0	-512	511
				Zoom	0	0	-512	511
				WideZoom	0	0	-512	511
				1080i Full / Normal	0	0	-512	511
				1080i Zoom	0	0	-512	511
				1080i WideZoom	0	0	-512	511
			G V Key	Full / Normal	0	0	-512	511
				Zoom	0	0	-512	511
				WideZoom	0	0	-512	511
				1080i Full / Normal	0	0	-512	511
				1080i Zoom	0	0	-512	511
				1080i WideZoom	0	0	-512	511
			B H Key	Full / Normal	0	0	-512	511
				Zoom	0	0	-512	511
				WideZoom	0	0	-512	511
				1080i Full / Normal	0	0	-512	511
				1080i Zoom	0	0	-512	511
				1080i WideZoom	0	0	-512	511
			B V Key	Full / Normal	-130	-130	-512	511
				Zoom	-130	-130	-512	511
				WideZoom	-130	-130	-512	511
				1080i Full / Normal	-130	-130	-512	511
				1080i Zoom	-130	-130	-512	511
				1080i WideZoom	-130	-130	-512	511

CATEGORY	#	ITEM	DESCRIPTION	CONDITION	SERVICE DATA (dec)			
					51WS655 (U/C)	57WS655 (U/C)	MIN	MAX
PJE	147	PIN	R H Pin	Full / Normal	0	0	-512	511
				Zoom	0	0	-512	511
				WideZoom	0	0	-512	511
				1080i Full / Normal	0	0	-512	511
				1080i Zoom	0	0	-512	511
				1080i WideZoom	0	0	-512	511
			R V Pin	Full / Normal	380	380	-512	511
				Zoom	380	380	-512	511
				WideZoom	380	380	-512	511
				1080i Full / Normal	380	380	-512	511
				1080i Zoom	380	380	-512	511
				1080i WideZoom	380	380	-512	511
			G H Pin	Full / Normal	0	0	-512	511
				Zoom	0	0	-512	511
				WideZoom	0	0	-512	511
				1080i Full / Normal	0	0	-512	511
				1080i Zoom	0	0	-512	511
				1080i WideZoom	0	0	-512	511
			G V Pin	Full / Normal	430	430	-512	511
				Zoom	430	430	-512	511
				WideZoom	430	430	-512	511
				1080i Full / Normal	430	430	-512	511
				1080i Zoom	430	430	-512	511
				1080i WideZoom	430	430	-512	511

CATEGORY	#	ITEM	DESCRIPTION	CONDITION	SERVICE DATA (dec)			
					51WS655 (U/C)	57WS655 (U/C)	MIN	MAX
PJE	147	PIN	B H Pin	Full / Normal	0	0	-512	511
				Zoom	0	0	-512	511
				WideZoom	0	0	-512	511
				1080i Full / Normal	0	0	-512	511
				1080i Zoom	0	0	-512	511
				1080i WideZoom	0	0	-512	511
			B V Pin	Full / Normal	380	380	-512	511
				Zoom	380	380	-512	511
				WideZoom	380	380	-512	511
				1080i Full / Normal	380	380	-512	511
				1080i Zoom	380	380	-512	511
				1080i WideZoom	380	380	-512	511
	148	MLIN	R H Middle Lin	Full / Normal	0	0	-512	511
				Zoom	0	0	-512	511
				WideZoom	0	0	-512	511
				1080i Full / Normal	0	0	-512	511
				1080i Zoom	0	0	-512	511
				1080i WideZoom	0	0	-512	511
			G H Middle Lin	Full / Normal	0	0	-512	511
				Zoom	0	0	-512	511
				WideZoom	0	0	-512	511
				1080i Full / Normal	0	0	-512	511
				1080i Zoom	0	0	-512	511
				1080i WideZoom	0	0	-512	511

CATEGORY	#	ITEM	DESCRIPTION	CONDITION	SERVICE DATA (dec)			
					51WS655 (U/C)	57WS655 (U/C)	MIN	MAX
PJE	148	MLIN	B H Middle Lin	Full / Normal	0	0	-512	511
				Zoom	0	0	-512	511
				WideZoom	0	0	-512	511
				1080i Full / Normal	0	0	-512	511
				1080i Zoom	0	0	-512	511
				1080i WideZoom	0	0	-512	511
				149	MSIZ	R H Middle Size	Full / Normal	0
	Zoom	0	0	-512			511	
	WideZoom	0	0	-512			511	
	1080i Full / Normal	0	0	-512			511	
	1080i Zoom	0	0	-512			511	
	1080i WideZoom	0	0	-512			511	
	G H Middle Size	Full / Normal	0	0			-512	511
		Zoom	0	0		-512	511	
		WideZoom	0	0		-512	511	
		1080i Full / Normal	0	0		-512	511	
		1080i Zoom	0	0		-512	511	
		1080i WideZoom	0	0		-512	511	
		B H Middle Size	Full / Normal	0		0	-512	511
	Zoom / V.Comp		0	0		-512	511	
	WideZoom		0	0		-512	511	
1080i Full	0		0	-512		511		
1080i Full	0		0	-512		511		
1080i V.Comp	0		0	-512		511		

2-11-1.ID MAP TABLE

CATEGORY	#	ITEM	DESCRIPTION	CONDITION	SERVICE DATA (dec)			
					KDP-51WS655(U/C)	KDP-57WS655(U/C)	MIN	MAX
ID	0	ID0	ID Byte 0	(common)	89	89	0	255
	1	ID1	ID Byte 1	(common)	255	255	0	255
	2	ID2	ID Byte 2	(common)	239	239	0	255
	3	ID3	ID Byte 3	(common)	106	106	0	255
	4	ID4	ID Byte 4	(common)	75	75	0	255
	5	ID5	ID Byte 5	(common)	243	243	0	255
	6	ID6	ID Byte 6	(common)	190	190	0	255
	7	ID7	ID Byte 7	(common)	155	155	0	255

2-12.REGISTRATION ADJUSTMENT (PJE MODE ONLY)

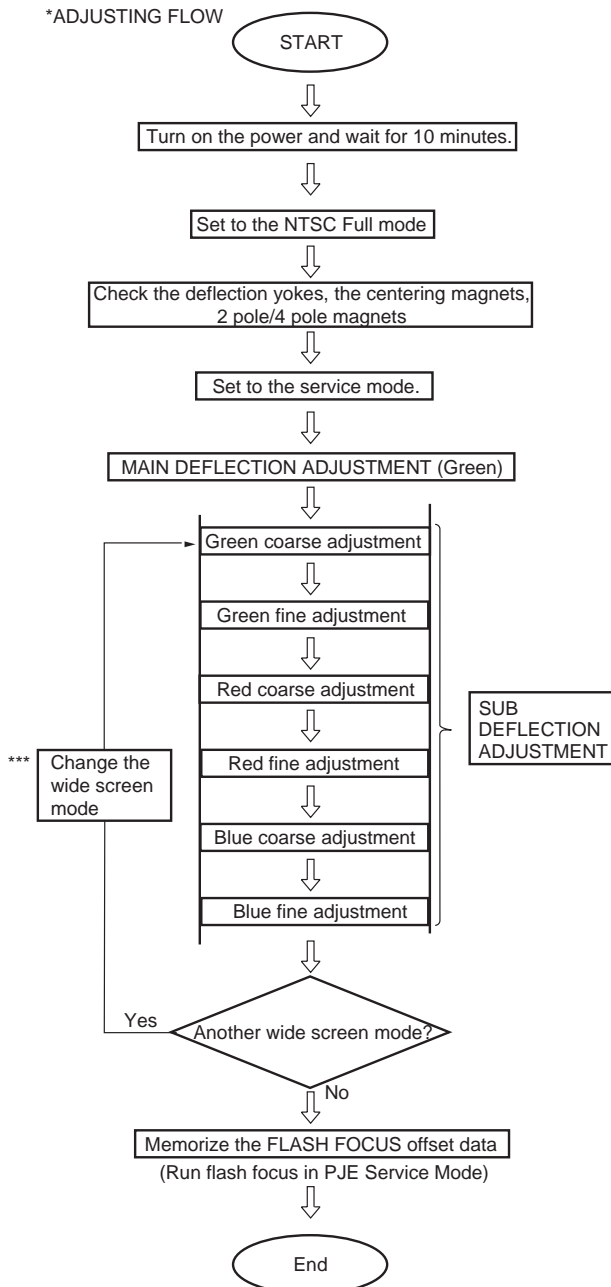

*** COPY

When the NTSC Full mode adjustment has finished, copy its data to NTSC Zoom, HD Full, and HD Zoom modes the first time only and be sure to adjust in the order given.

When the NTSC Wide Zoom mode adjustment has finished, copy its data to HD Wide Zoom mode.

This will serve as a starting point for adjusting these other modes. See section 2-13-2. Copying All Registration Data To Other Modes for more information.

2-12-1.SETUP FOR ADJUSTMENT

MARKING

- At the 4 sides of the screen, locate the middle. Use a tape measure to identify the middle.

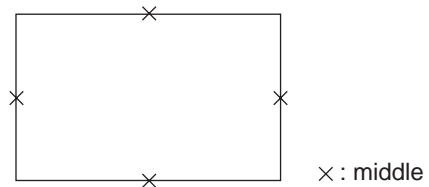

DATA SETTING

- Set NTSC Full mode.
- Enter the service mode, and select "PJE".

2-12-2.MAIN DEFLECTION ADJUSTMENT

NOTE: Before this adjustment, refer to section 2-11 SERVICE DATA LISTS for PJE item #141-149 input data.

- Cover the red and blue CRT lenses with lens caps to allow only green to show (or use the method shown in the note below for turning off the CRTs individually without using lens caps).
- Enter the monoscope signal and set to NTSC Full mode.
- Enter the service mode, and select "DEF1".
- Adjust "0 VPOS" and "1 VSIZ" so that the picture is displayed in the center of the screen.

0 VPOS

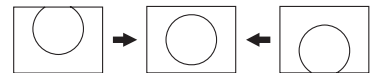

1 V-Size

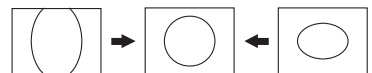

- Select "DEF2" and adjust "2 H-Size" so that the picture size is within the specification.

SPEC

Overscan Spec. = 9%

Input Signal	H SIZE	V SIZE
Monoscope	15.6 ± 0.2 sq.	11.5 ± 0.2 sq.

2 H-Size

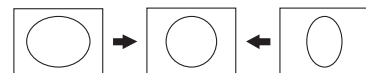

- Copy the data of the NTSC Full mode to the other wide screen mode and, if necessary, adjust in the other mode.

2-12-3. OPERATION METHOD FOR PROJECTOR ENGINE MODE

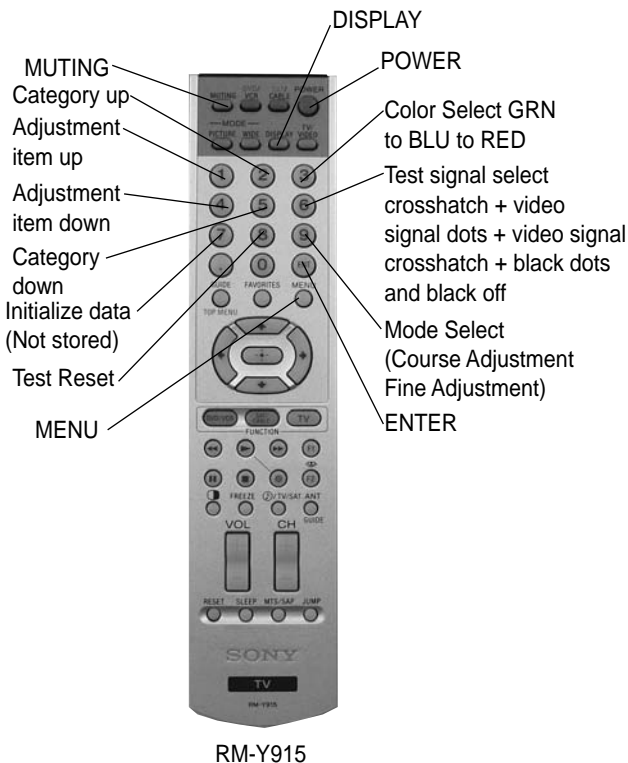

RM-Y915

1. FUNCTION OF KEYS ON COMMANDER

- ① Changes adjustment item. (Item # moves up)
Marker moves clockwise from center to outside. (In Fine Adjustment mode)
- ④ Changes adjustment item. (Item # moves down)
Marker moves counter clockwise from outside to center. (In Fine Adjustment mode)
- ② Changes adjustment category. (Category # moves up)
- ⑤ Changes adjustment category. (Category # moves down)

Joystick Changes data value. (Up or down)

Marker moves clockwise from center (up, down, right, and then left) to outside. (In Fine Adjustment mode)

- ③ Changes adjustment color. GRN →BLU →RED
- ⑥ Displays or changes internal test signals.
crosshatch + external signal →
crosshatch + borderline →
crosshatch only →
dot only → off
- ⑨ Switches adjustment mode.
Coarse adjustment model →
Fine adjustment point mode →
Fine adjustment row mode →
Fine adjustment column mode

Press Switches marker moving method.

Joystick (In Fine Adjustment mode)

Pressing down on the joystick in Fine Adjustment mode switches between selecting and un-selecting a point.

When a point is selected, the cursor changes to that color to indicate the point is selected and can be adjusted. If a point is not selected the cursor is white.

Joystick ▲ ▼ ◀ ▶ keys → 1 and 4 buttons

Commander Function

Buttons	Mode	Description
0 + ENTER	READ	Reads data to NVM.
MUTING+ENTER	WRITE	Writes data from NVM.
7 + ENTER	PJE INITIAL	Service data initialization. Not stored. (Be sure not to use usually)

2. OPERATION METHOD FOR COARSE ADJUSTMENT

1. Enter the service mode and select "PJE".
2. Press the "1" or "4" button on the remote commander to select the item, and then use the joystick to change the data.

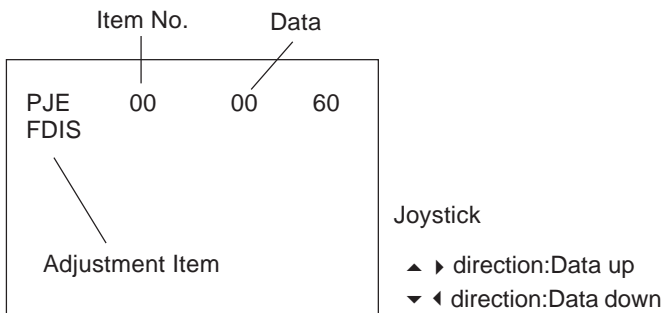

3. Select "GRN CENT". When BLU or RED is displayed, press the "3" button on the remote commander to change the adjustment color in the order of GRN →BLU →RED.
4. In the GRN, BLU, or RED mode, move the joystick ▲ or ▼ to change the data in vertical direction, or ◀ or ▶ to change the data in a horizontal direction.

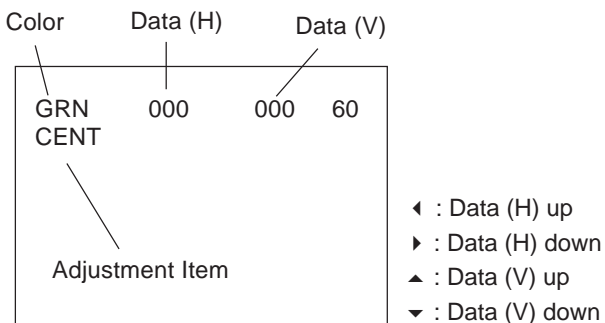

5. Before returning to the service mode, press the "MUTING" + "ENTER" buttons on the remote commander to write the data. (You must complete step 5 to write the data. If you omit step 5 the set data is returned to the data prior to the adjustment.)

3. OPERATION METHOD FOR FINE ADJUSTMENT

1. Enter the service mode and select "PJE".
2. Select FDIS and set the data to "01" so that the data at each position can be displayed in fine adjustment mode.
3. Press the "9" button on the remote commander and fine adjustment mode will be active where a green marker appears in the center of the screen. (In the case of GRN mode)
4. Press down on the joystick, and the marker color will be alternately switched between green (GRN mode) and white.
5. Press the "1" or "4" button on the remote commander or use the joystick to move the marker to the position to be adjusted, where fine adjustment can be made.

* When the marker color is white:
(in this case, fine adjustment is disabled)

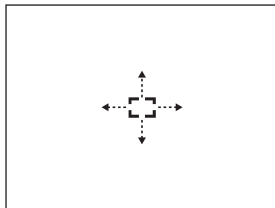

Use the joystick to move the marker up, down, left, or right.

* When the marker color is green:
(GRN mode)

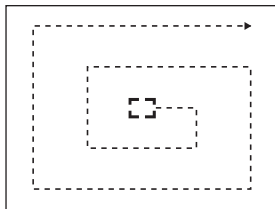

- ① : Moves the marker clockwise from the center to the outside.
- ④ : Moves the marker counter clockwise from the outside to the center.

* Fine adjustment can be made on the basis of a marker position using the joystick to move ▲ ▼ ◀ ▶.

Move joystick ▲ direction

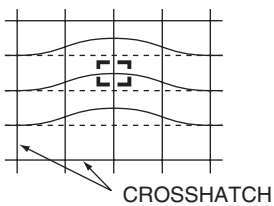

Move joystick ▶ direction

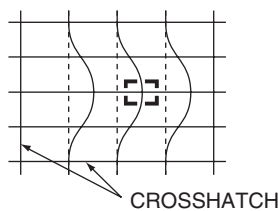

6. Press the "9" button on the remote commander to return to the coarse adjustment mode.

2-13.PJE ADJUSTMENT (SUB DEFLECTION ADJUSTMENT)

Adjustment item	Adjustment type		
	G	R	B
	H/V*	H/V*	H/V*
CENT	O/O	O/O	O/O
SKEW	O/O	O/O	O/O
SIZE	O/O	O/O	O/O
LIN	O/O	O/O	O/O
BOW	O/O	O/O	O/O
KEY	O/O	O/O	O/O
PIN	O/O	O/O	O/O
MLIN	O/-	O/-	O/-
MSIZ	O/-	O/-	O/-

* H = Horizontal V = Vertical O = Yes - = No

Note: If the value is over the limit value, adjust these in the fine adjustment.

Coarse Data Limit Value:

CENT H	-135 TO + 205
CENT V	-150 TO + 190
SKEW	-75 TO + 75
SIZE H	-75 MAX
BLUE H LIN	-425 MIN
RED H LIN	+425 MAX
FINE DATA LIMIT	± 107
Except the extreme left & right outside columns which have no limit	

2-13-1. ADJUSTMENT FOR NTSC FULL MODE

- The adjustment should be done in the numerical order given.

1) GREEN ADJUSTMENT

- Cover the red and blue CRT lenses with lens caps to allow only green to show (or use the method shown in the note below for turning off the CRTs individually without using lens caps).
- Enter the monoscope signal to set.
- Select the PJE mode.
- Press the "6" button on the remote commander to display the internal test signal (crosshatch).
- Select "GRN CENT", and adjust so that the pictures coincide in the center of screen.

Note: If lens caps are unavailable, you can cut off the unnecessary color beams by controlling the service mode MCP-RON, GON, BON.

GRN CENT (Horizontally/Vertically)

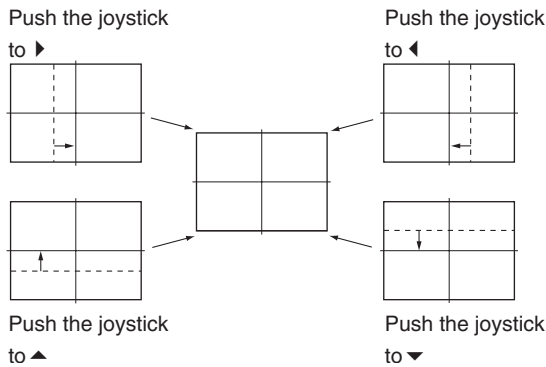

- Select "GRN SKEW", and correct the tilt of horizontal lines and vertical lines.

GRN SKEW (Horizontally/Vertically)

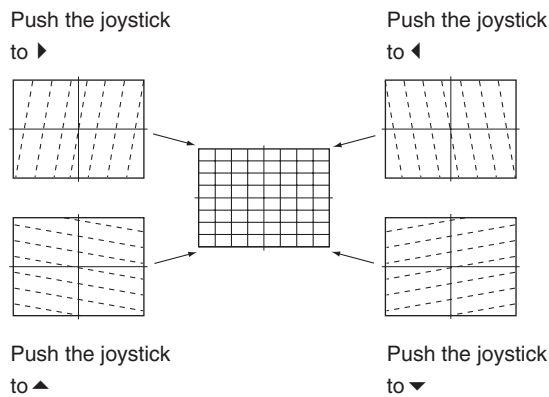

- Select "GRN SIZE", and adjust so that each distance from center to left end and to right end is equal. Adjust so that each distance from center to top and to bottom is equal.

GRN SIZE (Horizontally/Vertically)

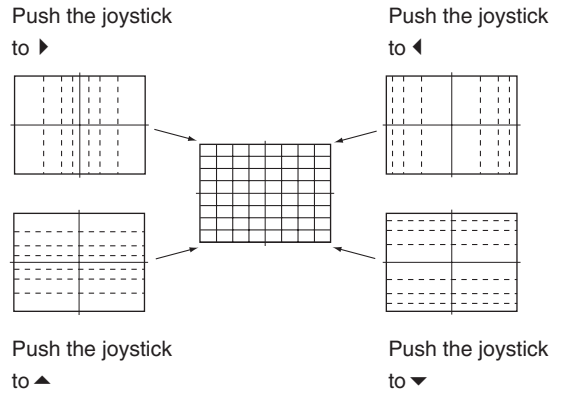

- Select "GRN LIN", and adjust so that each space at the right end and at the left end of screen is equal. Adjust so that each space at the top and at the bottom of screen is equal.

GRN LIN (Horizontally/Vertically)

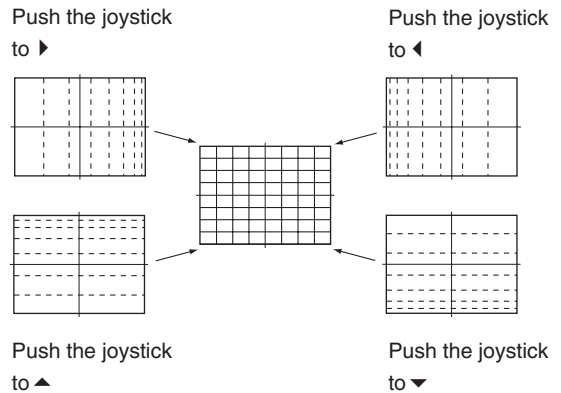

- Select "GRN BOW", and adjust so that the raster is not curved.

GRN BOW (Horizontally/Vertically)

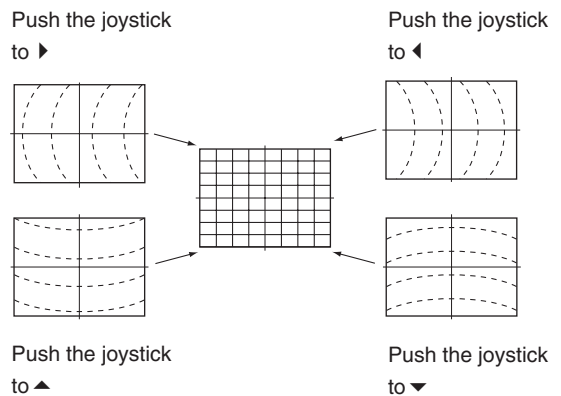

10. Select "GRN MSIZ", and correct the space intervals for the horizontal section so the screen is equal.

GRN MSIZ (Horizontally)

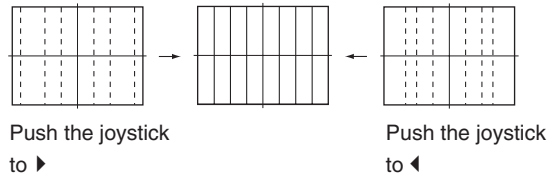

11. Select "GRN MLIN", and correct the sizes of the horizontal line so the center of the screen is symmetrical left and right.

GRN MLIN (Horizontally)

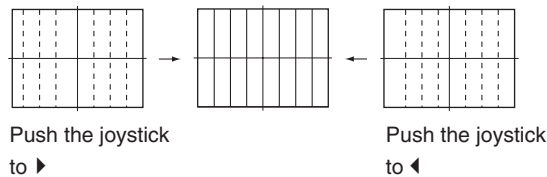

Note: The SIZE and LIN, MSIZ and MLIN adjustments affect each other. If necessary, adjust these mutually.

12. Select "GRN PIN", and adjust so that right and left vertical lines on the screen become straight. Adjust so that upper and lower horizontal lines on the screen become straight.

GRN PIN (Horizontally/Vertically)

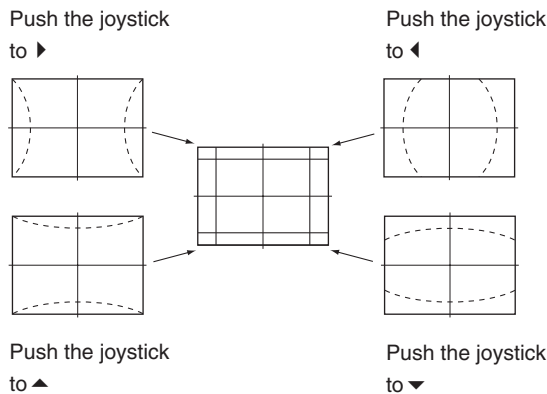

13. Select "GRN KEY", and adjust so that upper and lower horizontal lines on the screen become parallel.

GRN KEY (Vertically)

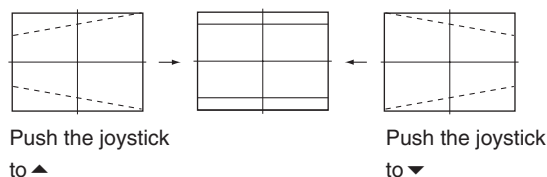

Note: The VPIN and KEY adjustments affect each other. If necessary, adjust these mutually.

14. Press the "9" button on the remote commander to enter fine adjustment mode.
15. Make the fine adjustment so that horizontal lines and vertical lines become straight.
16. Press the "9" button on the remote commander to return to coarse adjustment mode.

2) RED ADJUSTMENT

1. Cover the blue CRT lens with a lens caps to allow only the green and red to show (or use the method shown in the note below for turning off the CRTs individually without using lens caps).
2. Press the "3" button on the remote commander to select RED mode.
3. Adjust the following items so that red lines overlap with green lines.
 - RED CENT (horizontally/vertically)
 - RED SKEW (horizontally/vertically)
 - RED SIZE (horizontally/vertically)
 - RED LIN (horizontally/vertically)
 - RED MSIZ (horizontally)
 - RED MLIN (horizontally)
 - RED PIN (horizontally/vertically)
 - RED KEY (vertically)
4. Press the "9" button on the remote commander to enter fine adjustment mode.
5. Make the fine adjustment so that horizontal lines and vertical lines overlap with green lines.
6. Press the "9" button on the remote commander to return to coarse adjustment mode.

Note: If lens caps are unavailable, you can cut off the unnecessary color beams by controlling the service mode MCP-RON, GON, BON.

3) BLUE ADJUSTMENT

1. Remove the lens cap from the blue picture lens to display all colors.
2. Press the "3" button on the remote commander to select BLU mode.
3. Adjust the following items so that blue lines overlap with green lines.
 - BLU CENT (horizontally/vertically)
 - BLU SKEW (horizontally/vertically)
 - BLU SIZE (horizontally/vertically)
 - BLU LIN (horizontally/vertically)
 - BLU PIN (horizontally/vertically)
 - BLU KEY (vertically)
4. Press the "9" button on the remote commander to enter fine adjustment mode.
5. Make the fine adjustment so that horizontal lines and vertical lines overlap with green and red lines.
6. Press the "9" button on the remote commander to return to coarse adjustment mode.

Note: When replacing CRTs, adjust the set-up adjustments (2-1 to 2-9) and the registration adjustment (2-12). When replacing multiple CRTs at the same time, replace and adjust them individually.

4) REGISTRATION DATA WRITING

1. After completing each adjustment of green, blue, and red for the NTSC Full mode press the "MUTING"+ "ENTER" buttons in PJE service mode on the remote commander to write the registration data to the NVM.

2-13-2. COPYING ALL REGISTRATION DATA TO OTHER MODES

1. Make sure that the adjustment for NTSC Full mode is complete and the data has already been written.
2. Select the PJE mode.
3. Select Copy and set the data to "01", and press the "MUTING"+"ENTER" buttons on the remote commander.
4. The data from the NTSC Full mode is copied to NTSC Zoom Screen, HD Full Screen, and HD Zoom Screen modes.

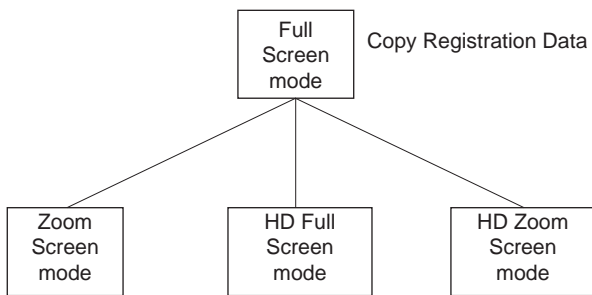

5. Make sure that the adjustment for NTSC Wide Zoom mode is complete and the data has already been written.
6. Select the PJE mode.
7. Select Copy and set the data to "01", and press the "MUTING"+"ENTER" buttons on the remote commander.
8. The data from the NTSC Wide Zoom mode is copied to HD Wide Zoom Screen mode.

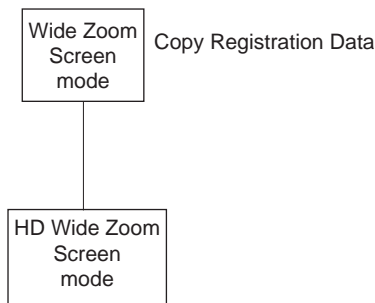

9. Check in the other modes and adjust as demands.
Be sure to write data in each mode.

2-14.AUTO REGISTRATION OFFSETS

IMPORTANT

This adjustment must be performed after registration adjustment or after readjustment for any reason!

Once registration in all modes is satisfactory:

1. Darken the room environment near the set.
2. Select input of RF (with a signal) or Video1 - Video4 (with a signal), and enter Full Mode.
WARNING: DO NOT USE 1080i SIGNAL!
3. Enter service mode and select the PJE group.
4. Press the "MUTING" + "ENTER" buttons on the remote commander to write the data for Full mode.

Important:

You must complete step 4 even if registration looks OK in Full mode and there were not any adjustments made.

5. To automatically store the offset values, press the "FLASH FOCUS" button on the front panel of the set.
(The offset value is now stored)
If FLASH FOCUS successfully calibrates, it displays "CALIBRATION OK."
If FLASH FOCUS does not successfully calibrate, an error message is displayed. (Refer to section 2-15)
6. Exit the service mode.
7. If the calibration was successful, press the "FLASH FOCUS" button out of service mode.
8. Confirm registration is OK in all modes.

2-15.AUTO REGISTRATION ERROR CODES

If an error code is displayed after the set has been correctly adjusted, check the following items: position, tilt and sizing. If any of these adjustments are off, even slightly, the auto-registration pattern will not hit the four sensors properly. This occurs when the internal generator patterns are being flashed on the screen for the sensors to read. Therefore, auto registration (called auto convergence) cannot operate properly, causing an error code to be displayed. In order for this function to operate properly, position, tilt and size must be adjusted properly.

ERROR CODE LIST

ERROR CODE	DESCRIPTION	NOTE
00	No Error	
10	Sensor 0 low output	Check sensor 0, connection/wiring, circuit, and pattern position (are patterns hitting sensor?) adjust 130 VUP, 134 HMID if necessary.
11	Sensor 1 low output	Check sensor 1, connection/wiring, circuit, and pattern position (are patterns hitting sensor?) adjust 133 HLE, 131 VMID if necessary.
12	Sensor 2 low output	Check sensor 2, connection/wiring, circuit, and pattern position (are patterns hitting sensor?) adjust 135 HRIV, 131 VMID if necessary.
13	Sensor 3 low output	Check sensor 3, connection/wiring, circuit, and pattern position (are patterns hitting sensor?) adjust 132 VLOW, 134 HMID if necessary.
20	Sensor 0 high output	Check sensor 0 and circuit.
21	Sensor 1 high output	Check sensor 1 and circuit.
22	Sensor 2 high output	Check sensor 2 and circuit.
23	Sensor 3 high output	Check sensor 3 and circuit.
30	V CENT or SKEW adjustment loop overflow	Check 131 VMID data and check registration condition.
31	H CENT or SKEW adjustment loop overflow	Check 134 HMID data and check registration condition.
32	H LIN or SIZE adjustment loop overflow	Check 133 HLE and 135 HRIT data and check registration condition.
40	V CENT regi data overflow	Check 131 VMID data and confirm V CENT data (all modes) is not near 511.
41	H CENT regi data overflow	Check 134 HMID data and confirm H CENT data (all modes) is not near 511.
42	V SKEW regi data overflow	Check 131 VMID data and confirm V SKEW data (all modes) is not near 511.
43	H SKEW regi data overflow	Check 134 HMID data and confirm H SKEW data (all modes) is not near 511.
44	H LIN regi data overflow	Check 133 HLE and 135 HRIT data and confirm H CENT data (all modes) is not near 511.
45	H SIZE regi data overflow	Check 133 HLE and 135 HRIT data and confirm H CENT data (all modes) is not near 511.
50	V CENT regi data overdraw	Check 131 VMID data and confirm V CENT data (all modes) is not near -512.
51	H CENT regi data overdraw	Check 134 HMID data and confirm H CENT data (all modes) is not near -512.
52	V SKEW regi data overdraw	Check 131 VMID data and confirm V SKEW data (all modes) is not near -512.
53	H SKEW regi data overdraw	Check 134 HMID data and confirm H SKEW data (all modes) is not near -512.
54	H LIN regi data overdraw	Check 133 HLE and 135 HRIT data and confirm H CENT data (all modes) is not near -512.
55	H SIZE regi data overdraw	Check 133 HLE and 135 HRIT data and confirm V CENT data (all modes) is not near -512.
60	CENT/SKEW calibration loop overflow	Check 134 HMID and 131 VMID data and check registration condition.
61	SIZE/LIN calibration loop overflow	Check 133 HLE, 135 HRIT, 130 VUP, and 132 VLOW data and check registration condition.
70	V CENT/SKEW ratio limit	Check sensors 1 and 2, connection/wiring, circuit, increase 129 RTML.
71	H CENT/SKEW ratio limit	Check sensors 0 and 3, connection/wiring, circuit, increase 129 RTML.
73	H SIZE/Lin ratio limit	Check sensors 1 and 2, connection/wiring, circuit, increase 129 RTML.
80	SIZE Limit Error	Check that horizontal SIZE data is not near 128 SZLM.

* In the case of multiple errors, last error is displayed.

SENSOR POSITIONS

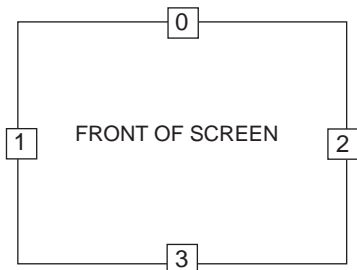

- 0: UPPER SENSOR
- 1: LEFT SENSOR
- 2: RIGHT SENSOR
- 3: LOWER SENSOR

• ERROR CODE SCREEN DISPLAY

Error codes in normal (customer) mode are not displayed. You must enter PJE service mode to see the error code.

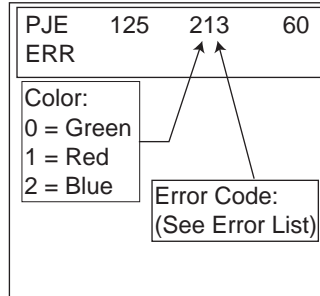

(Blue Sensor 3 Low Output)

In service mode, the error will be displayed in text format.

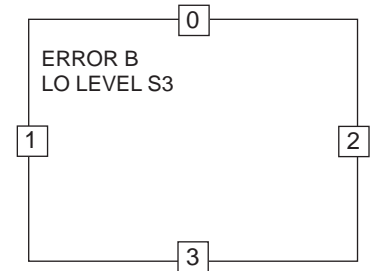

2-16.AUTO REGISTRATION DIAGNOSTICS

The TEST service item (PJE #136) can be used to determine if a sensor or sensor amplifier is working properly. It can also be used to check pattern positions.

133

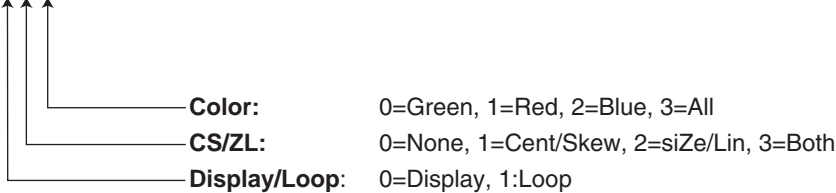

DISPLAY/ LOOP	CS/ZL	COLOR	ACTION
(0)	0	0	Normal calibration (no diagnostics).
(0)	X	X	Performs one adjustment cycle, then displays average peak voltages for the specified CS/ZL and Color.
(0)	3	3	Does nothing (can't display more than one CS/ZL or Color at a time.)
1	X	X	Adjusts specified CS/ZL and Color until a key is pressed. Useful for measuring signals with oscilloscope.

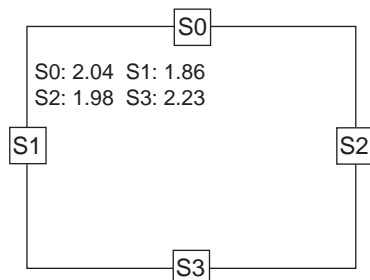



Sensor 0 peak voltage = 2.04 V, etc.

SECTION 3: SAFETY-RELATED ADJUSTMENTS

D BOARD

3-1. HV REGULATION CIRCUIT CHECK AND ADJUSTMENT

When replacing the following components marked with a  on the schematic diagram always check the HV regulation, and if necessary re-adjust.

Part Replaced ()	Adjustment ()
D BOARD T8001 (RHT), IC8002, IC8004, IC8005, PH8003, R8014, R8015, R8017, R8060, R8012	HV REGULATOR RV8002

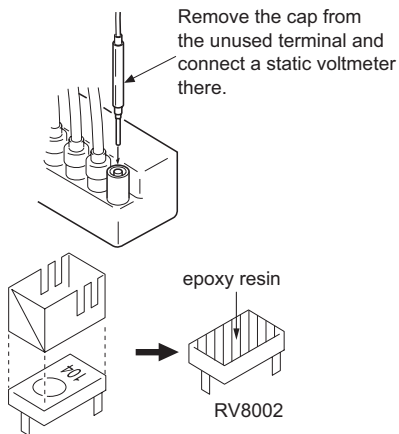

HV REGULATION ADJUSTMENT

1. Receive the all white signal.
2. Set PIC MAX/BRT CENT.
3. Connect a HV static voltmeter to the unconnected plug of the high-voltage block.
4. Power on the set.
5. Receive the all white signal.
6. Set PIC MAX/BRT CENT.
7. Confirm that the static voltmeter reading is $31.0 \pm 0.3kV$.
8. If not, adjust with RV8002 to the specified value.
9. After adjustment, put the VR cover on RV8002 (as shown below) and apply sufficient amount of epoxy resin around RV8002 .



3-2. HV HOLD DOWN CIRCUIT OPERATION CHECK

When replacing the following components marked with a  on the schematic diagram always check the hold-down operation.

Part Replaced ()	Adjustment ()
D BOARD T8001 (RHT), D8022, IC8001, IC8104, R8008, R8016, R8046, R8052, R8072, R8078, R8079, R8165, R8019	HV HOLD DOWN RV8002

OPERATION CHECK

1. Receive any source.
2. Using an external DC supply, apply 5 VDC to pin 3 of CN5 on A Board. Set will shutdown.

G BOARD

3-3. +B MAX VOLTAGE CONFIRMATION

The following adjustments should always be performed when replacing IC6503 R6590.

1. Supply 130VAC to variable autotransformer.
2. Receive dot signal pattern and set the PICTURE and BRIGHTNESS settings to their minimum.
3. Confirm the voltage of TP +B 135V is less than 137.0Vdc.
4. If step 3 is not satisfied, replace IC6503 and repeat steps 1-3.

3-4. +B OVP CONFIRMATION

1. Turn on set.
2. Set input conditions.
3. Turn off set.
4. Separate R6809 (D Board) from +135.
5. Apply external $160 \pm 1V$ DC to open end of R6809.
6. Turn on set.
7. Measure voltage at Pin 8 of CN5006 (D Board). Voltage should be less than 0.8V.

Input Conditions

Input Voltage: 120VAC

Input Signal: Dot pattern NTSC

Video Controls: PICTURE set to minimum
BRIGHTNESS set to minimum

SECTION 4: CIRCUIT ADJUSTMENTS

4-1. P & P SUB CONTRAST ADJUSTMENT (VIDEO) (SCON)

- Receive the signal.
VIDEO 1 terminal Composite: Color-bar (white-75%, 7.5% setup)
- VIDEO MODE : Pro
PICTURE : Maximum
COLOR : Minimum
MCP RON = 0
BON = 0
- Set to P & P mode, and receive the color bars in both main and sub (left and right), and set to service mode.
- Connect an oscilloscope between the check point and ground.
Check points : A Board CN5 pin 6 (G)
- Select "CCPM-YLEV" (Main scon), and adjust so that the waveform level of VWB is $1.75 \pm 0.03V_{p-p}$.
- Select "YCTS-SCON" (Sub scon), and adjust so that the waveform level of VWB is $1.75 \pm 0.03V_{p-p}$.
- After completing the adjustments, write the data into memory by pressing "MUTING" → "ENTER" on the remote commander.

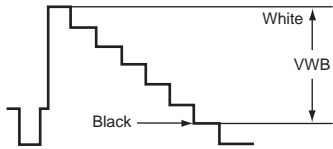

4-2. P & P SUB CONTRAST ADJUSTMENT (RF) (SCON)

- Receive the signal.
TV terminal RF : Color-bar (white-75%, 7.5% setup)
- VIDEO MODE : Pro
PICTURE : Maximum
COLOR : Minimum
MCP RON = 0
BON = 0
- Set to P & P mode, and receive the color bars in both main and sub (left and right), and set to service mode.
- Connect an oscilloscope between the check point and ground.
Check points : A Board CN5 pin 6 (G)
- Select "CCPM-YLEV" (Main scon), and adjust so that the waveform level of VWB is $1.75 \pm 0.03V_{p-p}$.
- Select "YCTS-SCON" (Sub scon), and adjust so that the waveform level of VWB is $1.75 \pm 0.03V_{p-p}$.
- After completing the adjustments, write the data into memory by pressing "MUTING" → "ENTER" on the remote commander.

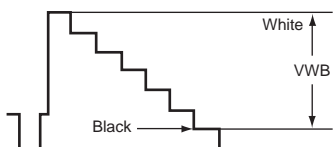

4-3. P & P SUB-HUE AND SUB-COLOR ADJUSTMENT VIDEO (SHUE, SCOL)

- Receive the signal.
VIDEO 1 terminal Composite: Color-bar (white-75%, 7.5% setup)
- VIDEO MODE : Pro
PICTURE : Maximum
COLOR : Center
- Set to P & P mode, and receive the color bars in both main and sub (left and right), set to service mode.
- Connect an oscilloscope between pin 7 of CN5 (A Board) connector and ground.
- Select "CCPM-CLEV, CCPM-SHUE" (Main), and adjust them to have $VB1 = VB4 \pm 40mV$ and $VB2 = VB3 \pm 40mV$ in the waveform levels.
- Select "YCTS-SCOL, YCTS-SHUE" (Sub), and adjust them to have $VB1 = VB4 \pm 40mV$ and $VB2 = VB3 \pm 40mV$ in the waveform levels.
- After completing the adjustments, write the data into memory by pressing "MUTING" → "ENTER" on the remote commander.

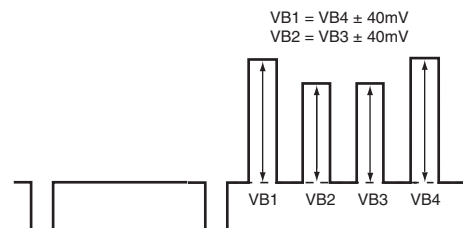

4-4. P & P SUB-HUE AND SUB-COLOR ADJUSTMENT (RF) (SHUE, SCOL)

- Receive the signal.
TV terminal : Color-bar (white-75%, 7.5% setup)
- VIDEO MODE : Pro
PICTURE : Maximum
COLOR : Center
- Set to P & P mode, and receive the color bars in both main and sub (left and right), set to service mode.
- Connect an oscilloscope between pin 7 of CN5 (A Board) connector and ground.
- Select "CCPM-CLEV, CCPM-SHUE" (Main), and adjust them to have $VB1 = VB4 \pm 40mV$ and $VB2 = VB3 \pm 40mV$ in the waveform levels.
- Select "YCTS-SCOL, YCTS-SHUE" (Sub), and adjust them to have $VB1 = VB4 \pm 40mV$ and $VB2 = VB3 \pm 40mV$ in the waveform levels.
- After completing the adjustments, write the data into memory by pressing "MUTING" → "ENTER" on the remote commander.

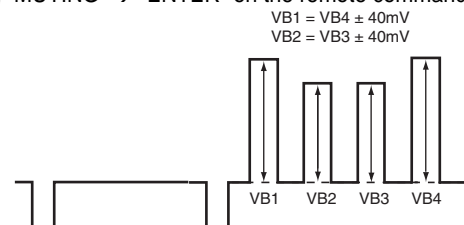

4-5. BLUE OFFSET ADJUSTMENT

1. Receive the all black (1080i, component) signal with VIDEO 5 input, and set PICTURE to maximum.
2. Connect an oscilloscope between CN5 7 pin (B) on the (A Board) and ground.
3. Set in the service mode and select the category "DEF2-SLIN".
4. Adjust "3 SLIN" so that the waveform level is $2.20 \pm 0.05V_{pp}$.
5. After completing the adjustments, write the data into memory by pressing "MUTING" → "ENTER" on the remote commander.
6. Receive the RF signal and change the wide screen mode to "Wide Zoom". Copy the same data to "DEF2-SLIN".

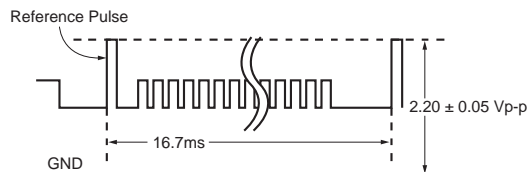

SECTION 5: DIAGRAMS

5-1. CIRCUIT BOARDS LOCATION

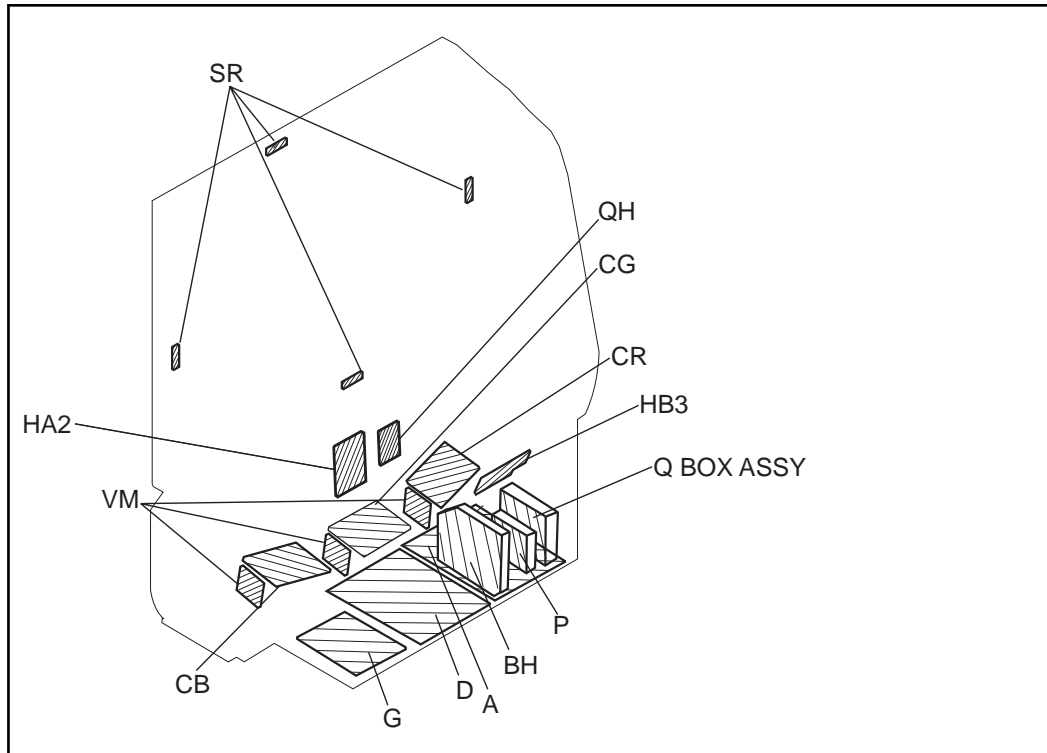

5-2. PRINTED WIRING BOARDS AND SCHEMATIC DIAGRAMS INFORMATION

All capacitors are in μF unless otherwise noted. pF : μF 50VV or less are not indicated except for electrolytics and tantalums.

All electrolytics are in 50V unless otherwise specified.

All resistors are in ohms. K=1000, M=1000k

Indication of resistance, which does not have one for rating electrical power, is as follows: Pitch : 5mm

Rating electrical power : $\frac{1}{4}$ W

$\frac{1}{4}$ W in resistance, $\frac{1}{10}$ W and $\frac{1}{8}$ W in chip resistance.

: nonflammable resistor.

: fusible resistor.

: internal component.

: panel designation and adjustment for repair.

: earth ground

: earth-chassis

All variable and adjustable resistors have characteristic curve B, unless otherwise noted.

Readings are taken with a NTSC color-bar signal input.

Readings are taken with a 10M digital multimeter.

Voltages are DC with respect to ground unless otherwise noted.

Voltage variations may be noted due to normal production tolerances.

All voltages are in V.

S : Measurement impossibility.

KDP-51WS655/57WS655

The components identified by shading and are critical for safety. Replace only with part number specified.

The symbol indicates a fast operating fuse and is displayed on the component side of the board. Replace only with fuse of the same rating as marked.

Les composants identifiés par un trame et une marque sont critiques pour la sécurité. Ne les remplacer que par une pièce portant le numéro spécifié.

Le symbole indique une fusible à action rapide. Doit être remplacé par une fusible de même valeur, comme marqué.



: B+ line

: B-line. (Actual measured value may be different).

: signal path. (RF)



Circled numbers are waveform references.

The components identified by  in this basic schematic diagram have been carefully factory-selected for each set in order to satisfy regulations regarding X-ray radiation. Should replacement be necessary, replace only with the value originally used.

When replacing components identified by , make the necessary adjustments as indicated. If the results do not meet the specified value, change the component identified by  and repeat the adjustment until the specified value is achieved.

(Refer to adjustments in Sections 3-1 and 3-2.)













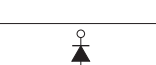





















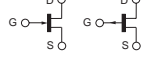

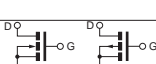



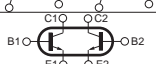

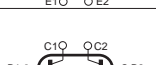

When replacing the parts listed in the table below, it is important to perform the related adjustments.

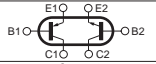
Part Replaced ()	Adjustment ()
D BOARD T8001 (RHT), IC8002, IC8004, IC8005, PH8003, R8014, R8015, R8017, R8060, R8012	HV REGULATOR RV8002
D BOARD T8001 (RHT), D8022, IC8001, IC8104, R8008, R8016, R8046, R8052, R8072, R8078, R8079, R8165, R8019	HV HOLD DOWN RV8002

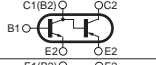
REFERENCE INFORMATION

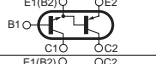
RESISTOR	: RN	METAL FILM
	: RC	SOLID
	: FPRD	NONFLAMMABLE CARBON
	: FUSE	NONFLAMMABLE FUSIBLE
	: RW	NONFLAMMABLE WIREWOUND
	: RS	NONFLAMMABLE METAL OXIDE
	: RB	NONFLAMMABLE CEMENT
	: 	ADJUSTMENT RESISTOR
COIL	: LF-8L	MICRO INDUCTOR
CAPACITOR	: TA	TANTALUM
	: PS	STYROL
	: PP	POLYPROPYLENE
	: PT	MYLAR
	: MPS	METALIZED POLYESTER
	: MPP	METALIZED POLYPROPYLENE
	: ALB	BIPOLAR
	: ALT	HIGH TEMPERATURE
	: ALR	HIGH RIPPLE

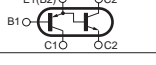
Terminal name of semiconductors in silk screen printed circuit (*)

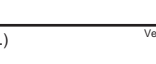
	Device	Printed symbol	Terminal name	Circuit
①	Transistor		Collector Base Emitter	
②	Transistor		Collector Base Emitter	
③	Diode		Cathode Anode	
④	Diode		Cathode Anode (NC)	
⑤	Diode		Cathode Anode (NC)	
⑥	Diode		Common Anode Cathode	
⑦	Diode		Common Anode Cathode	
⑧	Diode		Common Anode Anode	
⑨	Diode		Common Anode Anode	
⑩	Diode		Common Cathode Cathode	
⑪	Diode		Common Cathode Cathode	
⑫	Diode		Anode Anode Cathode Cathode	
⑬	Transistor (FET)		Drain Source Gate	
⑭	Transistor (FET)		Drain Source Gate	
⑮	Transistor (FET)		Source Drain Gate	
⑯	Transistor		Emitter Collector Base	
⑰	Transistor		C2 B1 E1 E2 B2 C1	
⑱	Transistor		C1 B2 E2 E1 B1 C2	
⑲	Transistor		C1 B2 E2 E1 B1 C2	
⑳	Transistor		C1 B2 E2 E1 B1 C2	
㉑	Transistor		E2 B1 E1 C2 C1(B2)	
㉒	Transistor		(B2) B1 E1 E2 C1 C2	
㉓	Transistor		(B2) E2 E1 B1 C2 C1	
-	Discrete semiconductor			

(Chip semiconductors that are not actually used are included.)

Ver.1.6

5-3. BLOCK DIAGRAMS

POWER BLOCK DIAGRAM

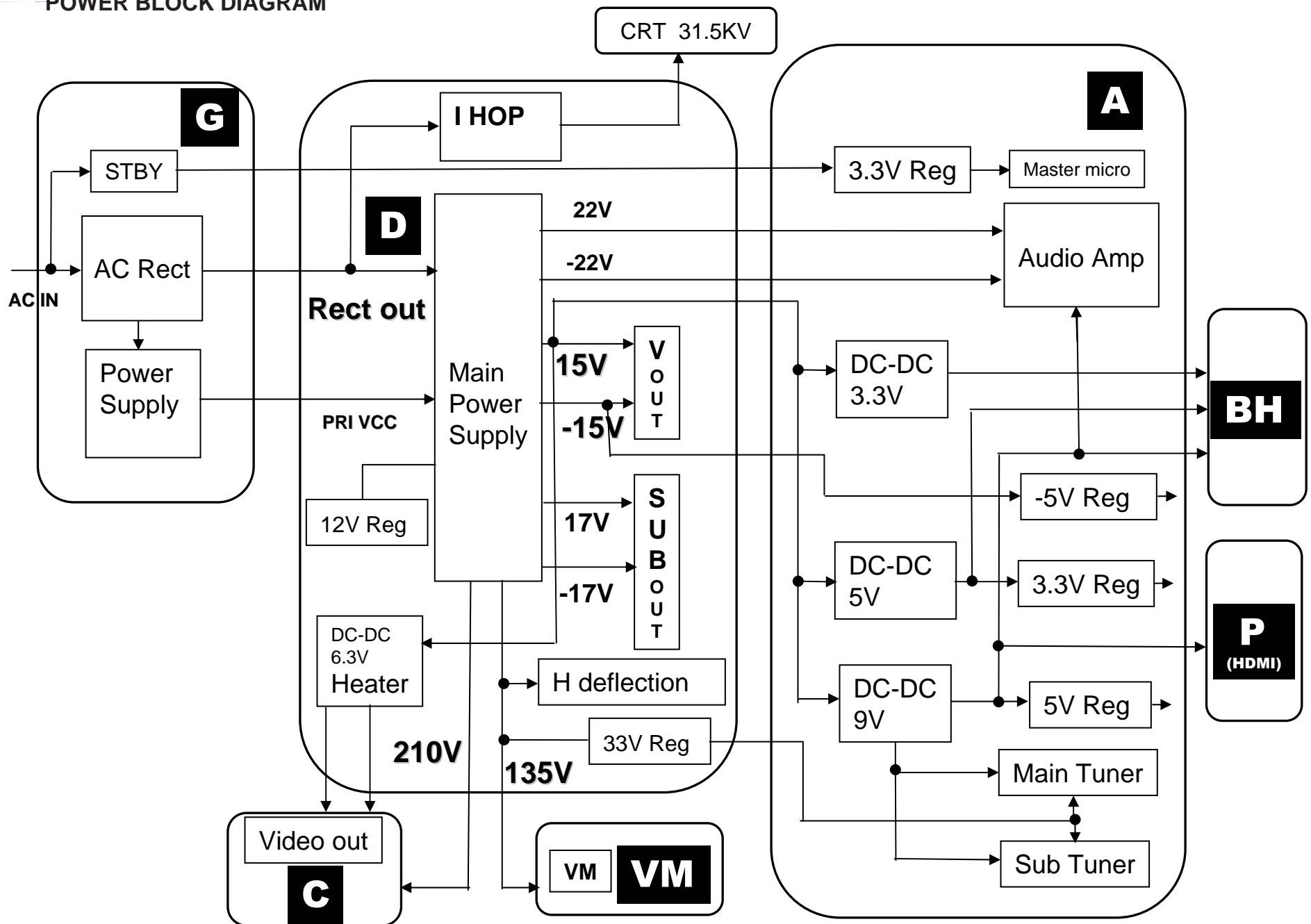

AUDIO SIGNAL PATH BLOCK DIAGRAM

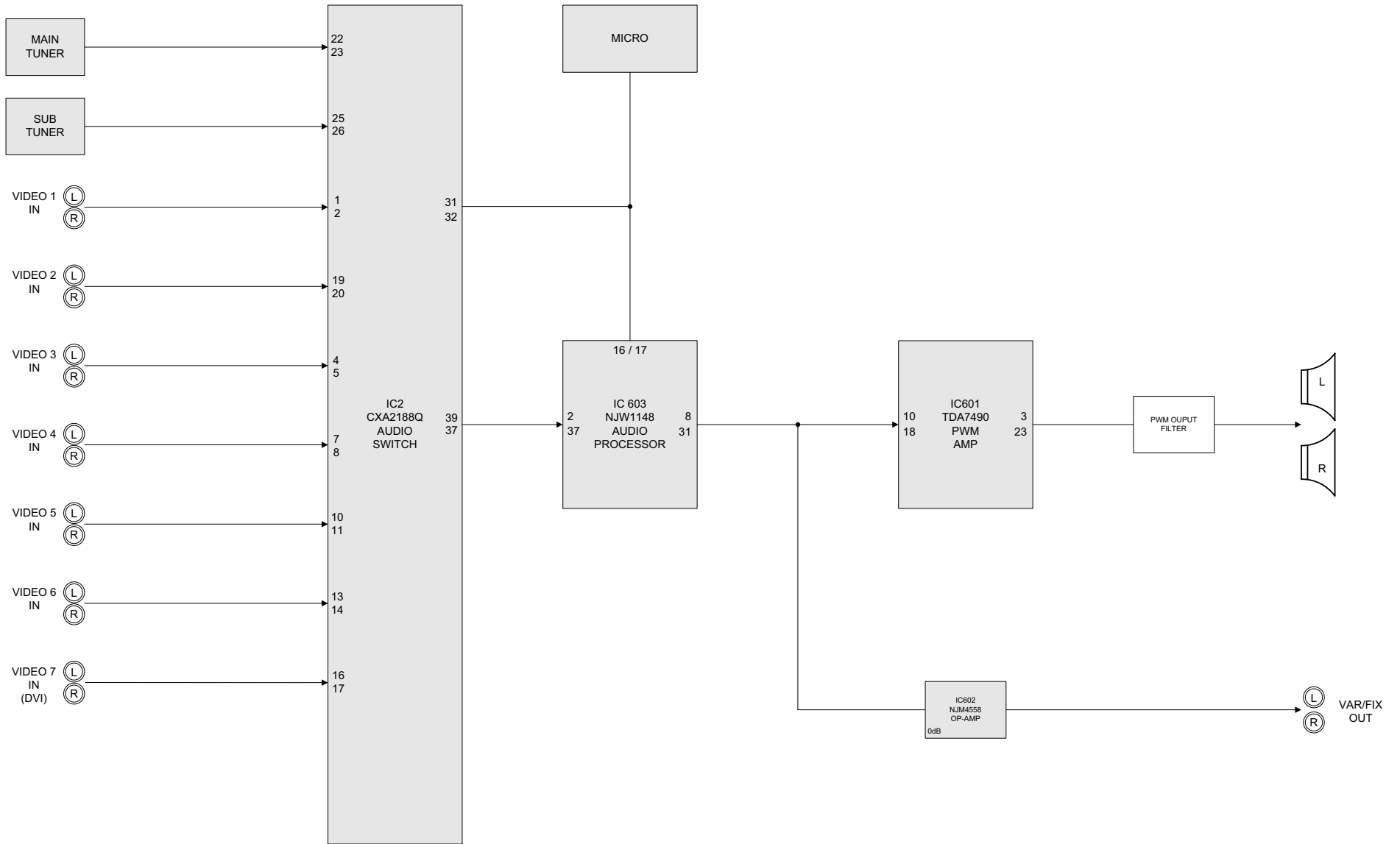

VIDEO PATH BLOCK DIAGRAM

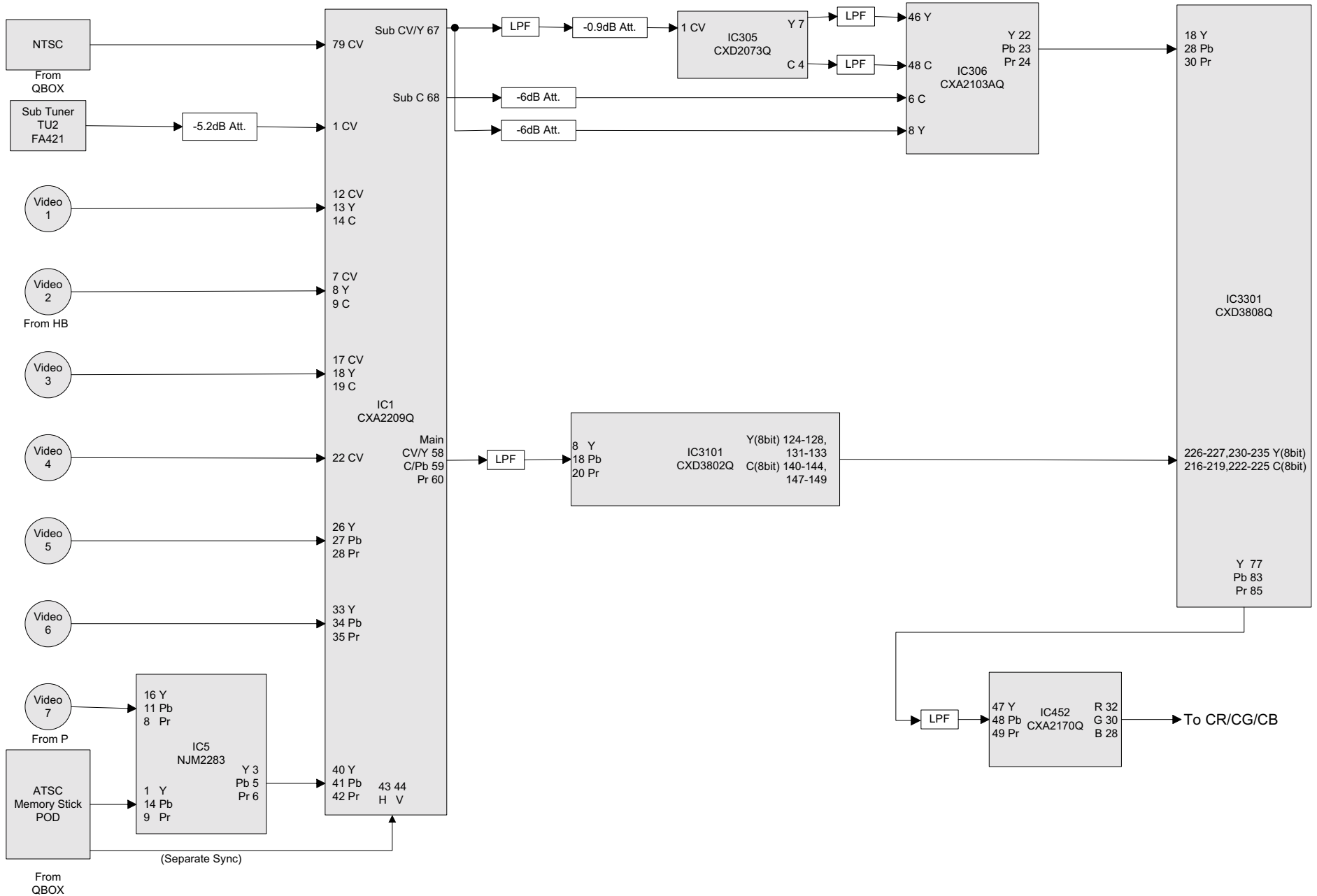

SYNC/OSD PATH BLOCK DIAGRAM

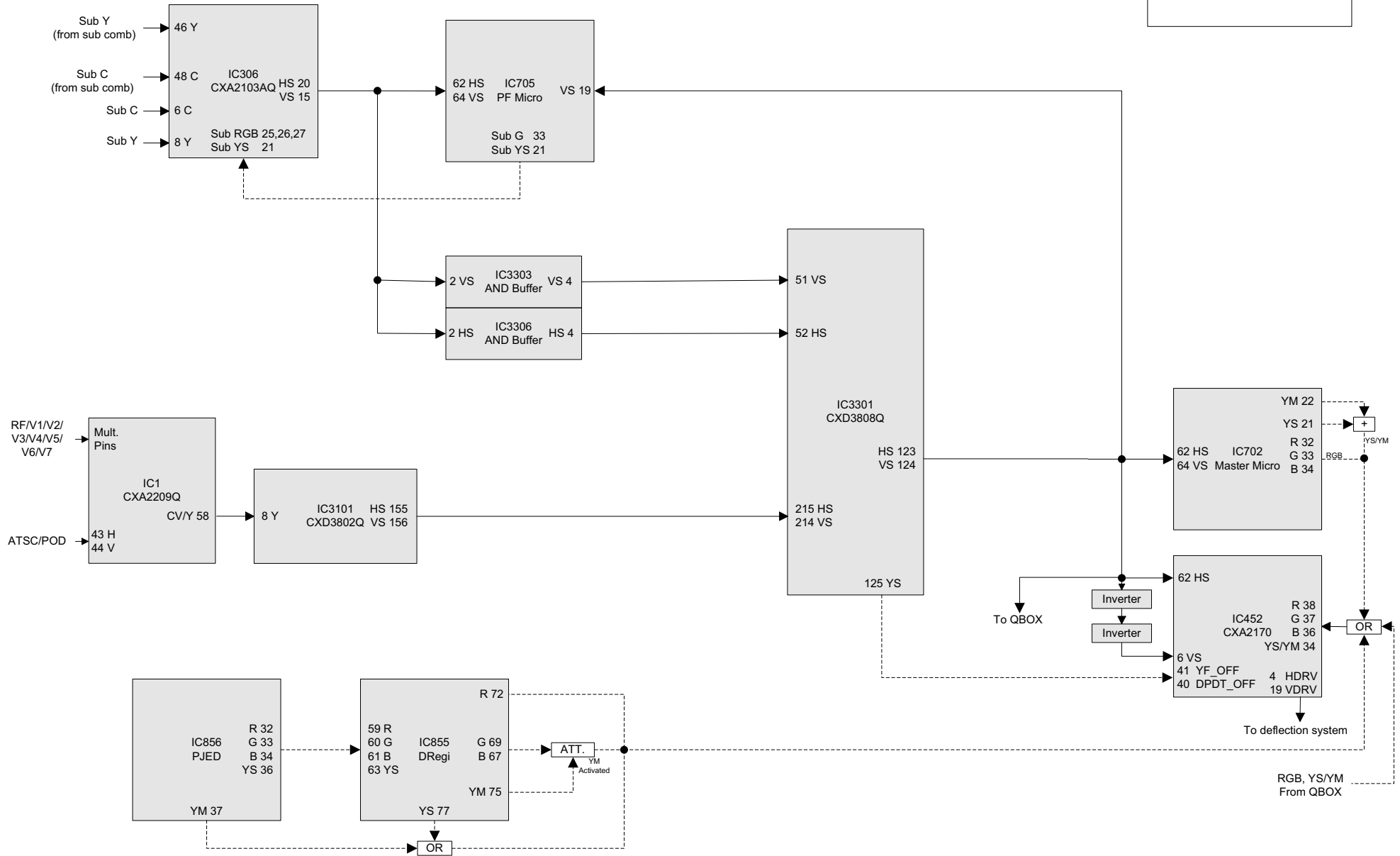
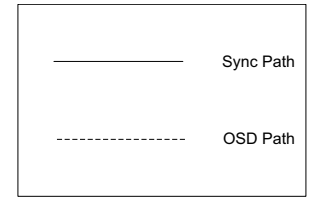

5-4. SCHEMATICS AND SUPPORTING INFORMATION
CR BOARD SCHEMATIC DIAGRAM

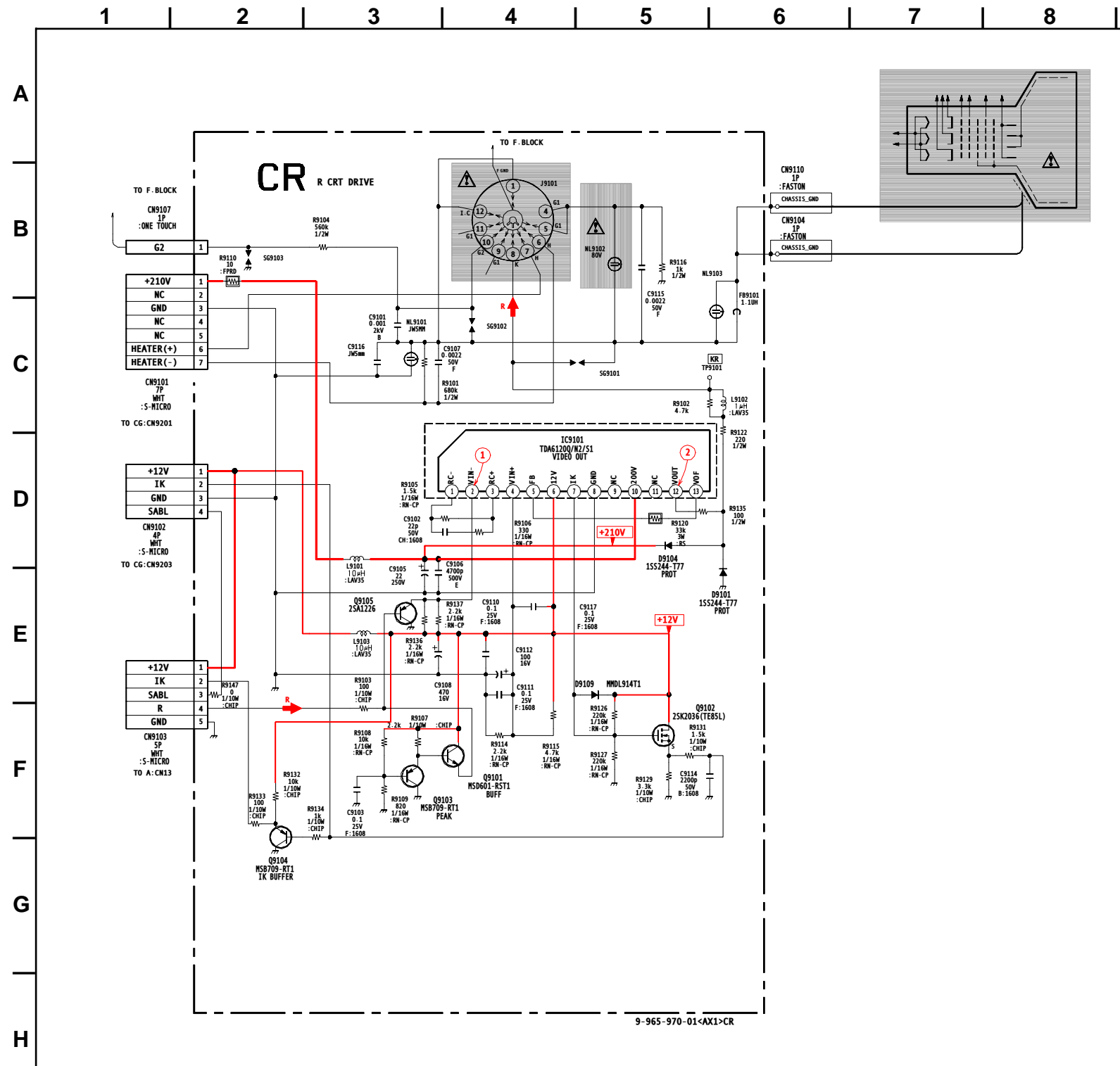

CR BOARD WAVEFORMS

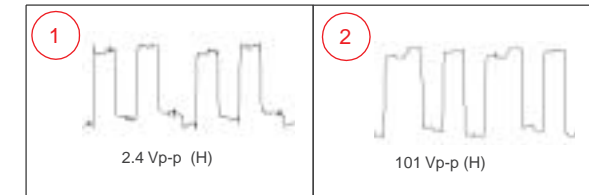

CR BOARD IC VOLTAGE LIST

IC9101			
PIN	VOLT	PIN	VOLT
1	2.0	8	GND
2	2.7	9	N/C
3	3.4	10	200.0
4	4.1	11	N/C
5	2.6	12	157.7
6	12.0	13	158.2
7	7.0		All voltages are in V.

CR BOARD TRANSISTOR VOLTAGE LIST

	B	C	E
Q9101	2.3	12.0	6.3
Q9103	1.7	GND	2.3
Q9104	8.4	GND	8.5
Q9105	2.3	GND	2.9

All voltages are in V.

	G	D	S
Q9102	7.0	12.0	5.7

CB BOARD SCHEMATIC DIAGRAM

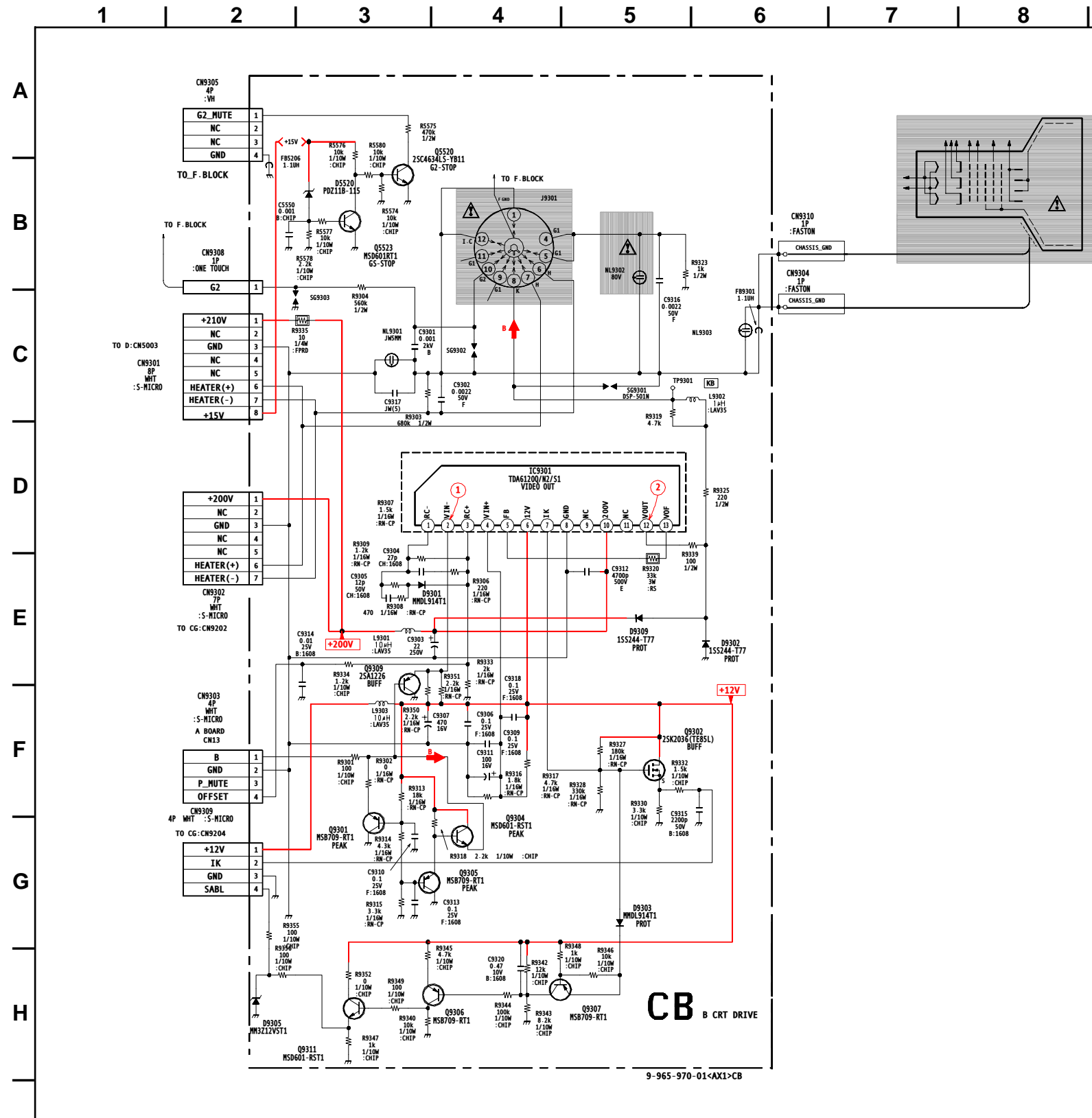

CB BOARD WAVEFORMS

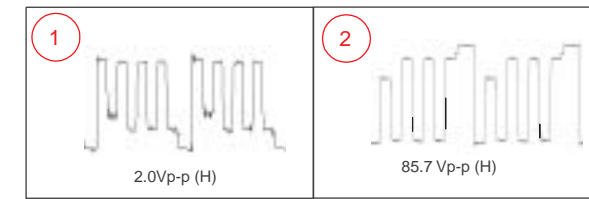

CB BOARD IC VOLTAGE LIST

IC9301			
PIN	VOLT	PIN	VOLT
1	2.1	8	GND
2	2.9	9	N/C
3	1.6	10	200.0
4	2.9	11	N/C
5	2.5	12	161.8
6	12.0	13	144.5
7	7.3		All voltages are in V.

CB BOARD TRANSISTOR VOLTAGE LIST

	B	C	E
Q5520	0.0	566.0	GND
Q5523	0.0	1.9	GND
Q9301	1.7	GND	2.3
Q9304	2.3	12.0	6.3
Q9305	1.7	GND	2.3
Q9306	7.3	7.7	7.8
Q9307	7.7	11.7	7.0
Q9309	2.3	GND	2.9
Q9311	0.0	12.1	7.6

All voltages are in V.

	G	D	S
Q9302	7.3	12.0	6.0

CG BOARD SCHEMATIC DIAGRAM

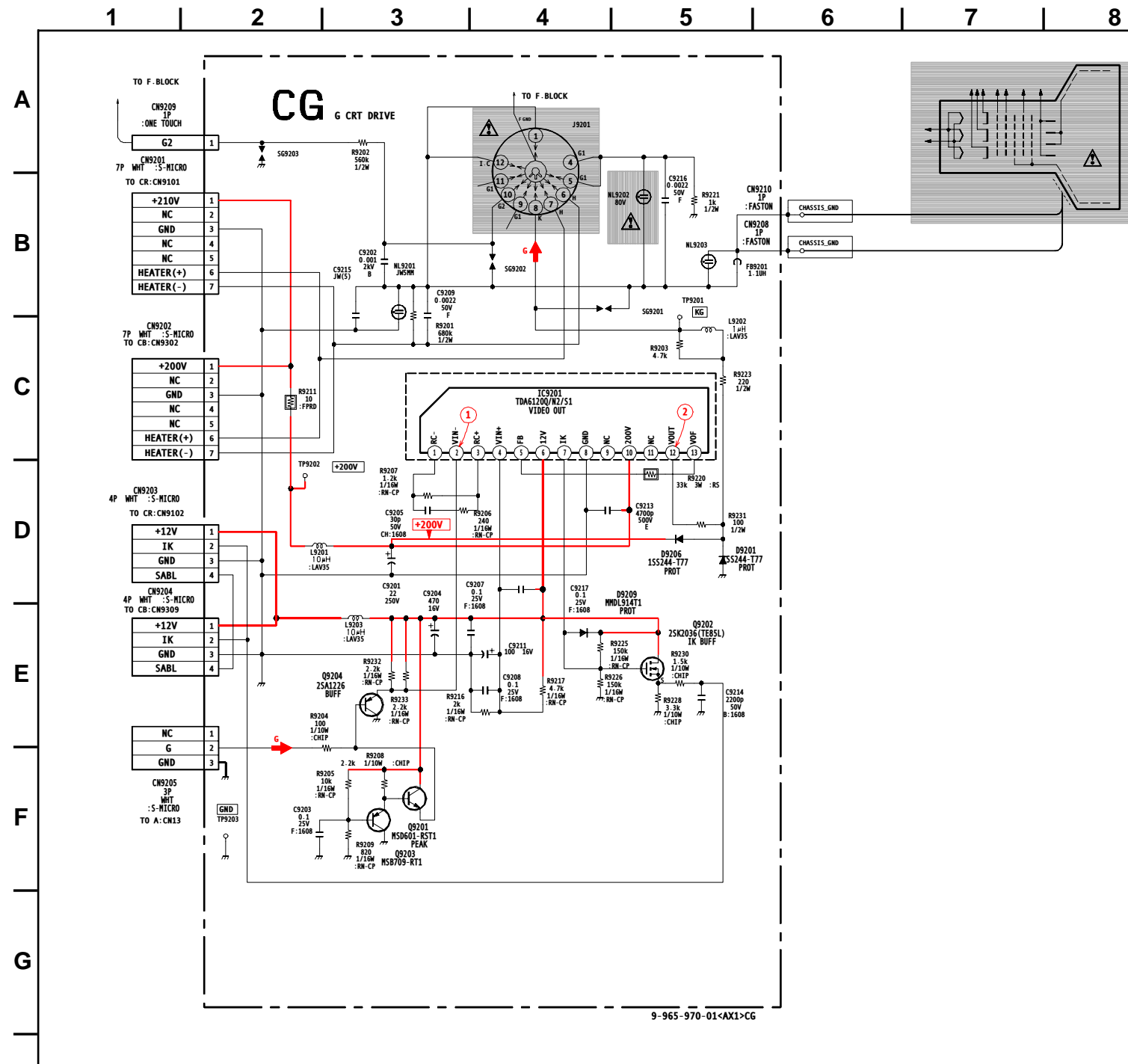

CG BOARD WAVEFORMS

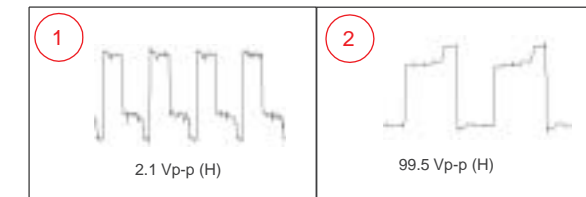

CG BOARD IC VOLTAGE LIST

IC9201			
PIN	VOLT	PIN	VOLT
1	1.9	8	GND
2	2.6	9	N/C
3	3.1	10	200.0
4	3.8	11	N/C
5	2.5	12	155.1
6	12.0	13	159.2
7	7.6		

All voltages are in V.

CG BOARD TRANSISTOR VOLTAGE LIST

	B	C	E
Q9201	2.3	12.0	6.3
Q9203	1.7	GND	2.3
Q9204	2.3	GND	2.9

All voltages are in V.

	G	D	S
Q9202	7.6	12.0	6.3

CR [R CRT DRIVE]

CB [B CRT DRIVE]

CG [G CRT DRIVE]

COMPONENT SIDE

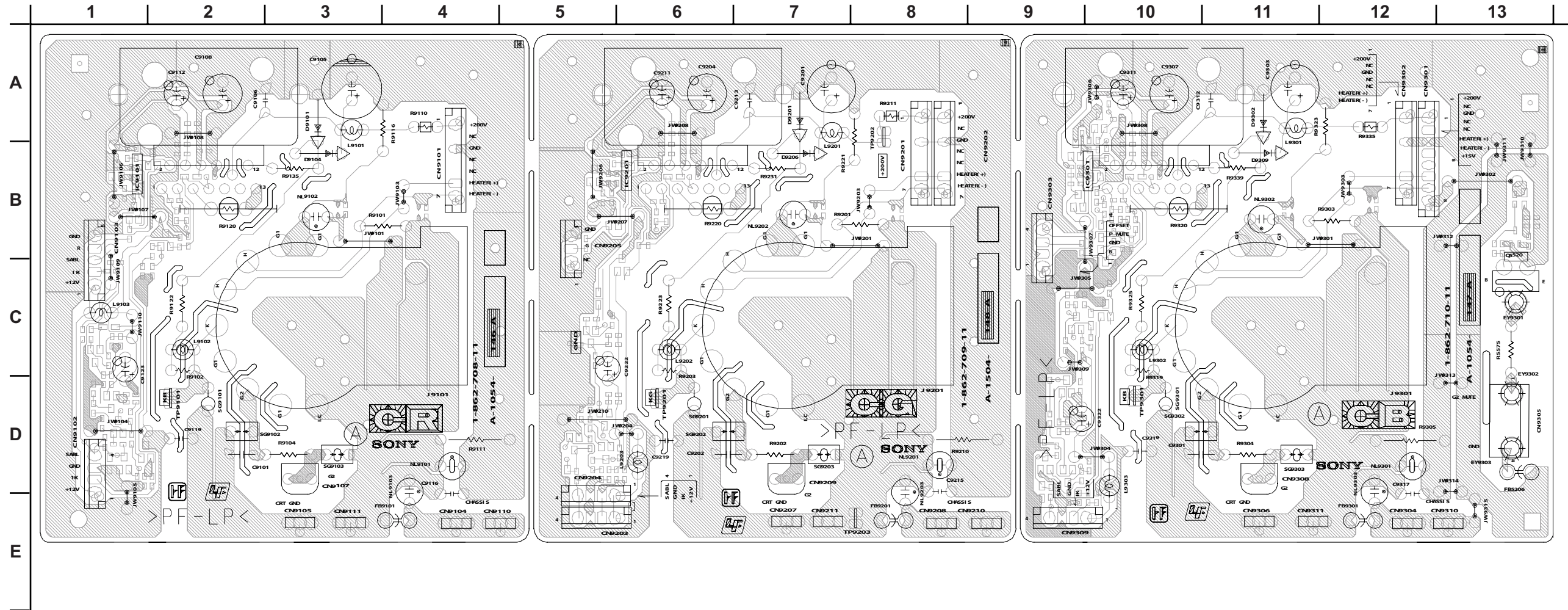

CR [R CRT DRIVE]

CB [B CRT DRIVE]

CG [G CRT DRIVE]

CONDUCTOR SIDE

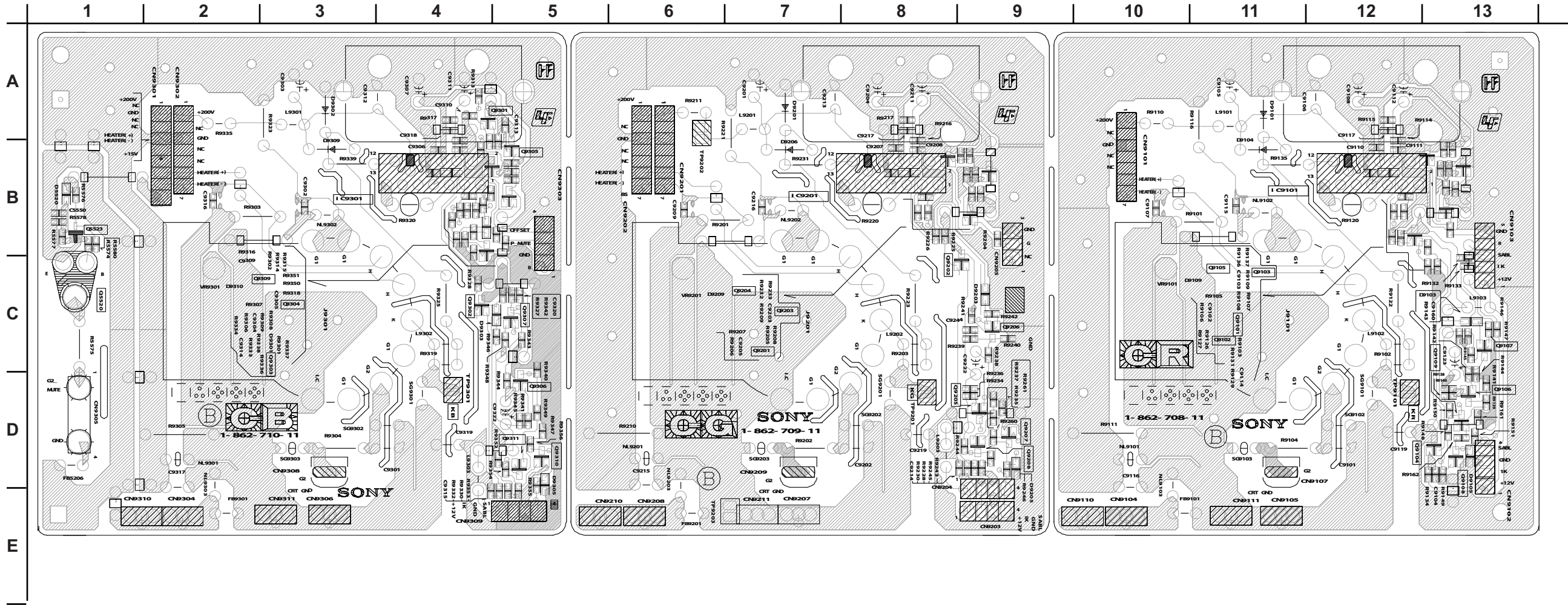

VM BOARD SCHEMATIC DIAGRAM

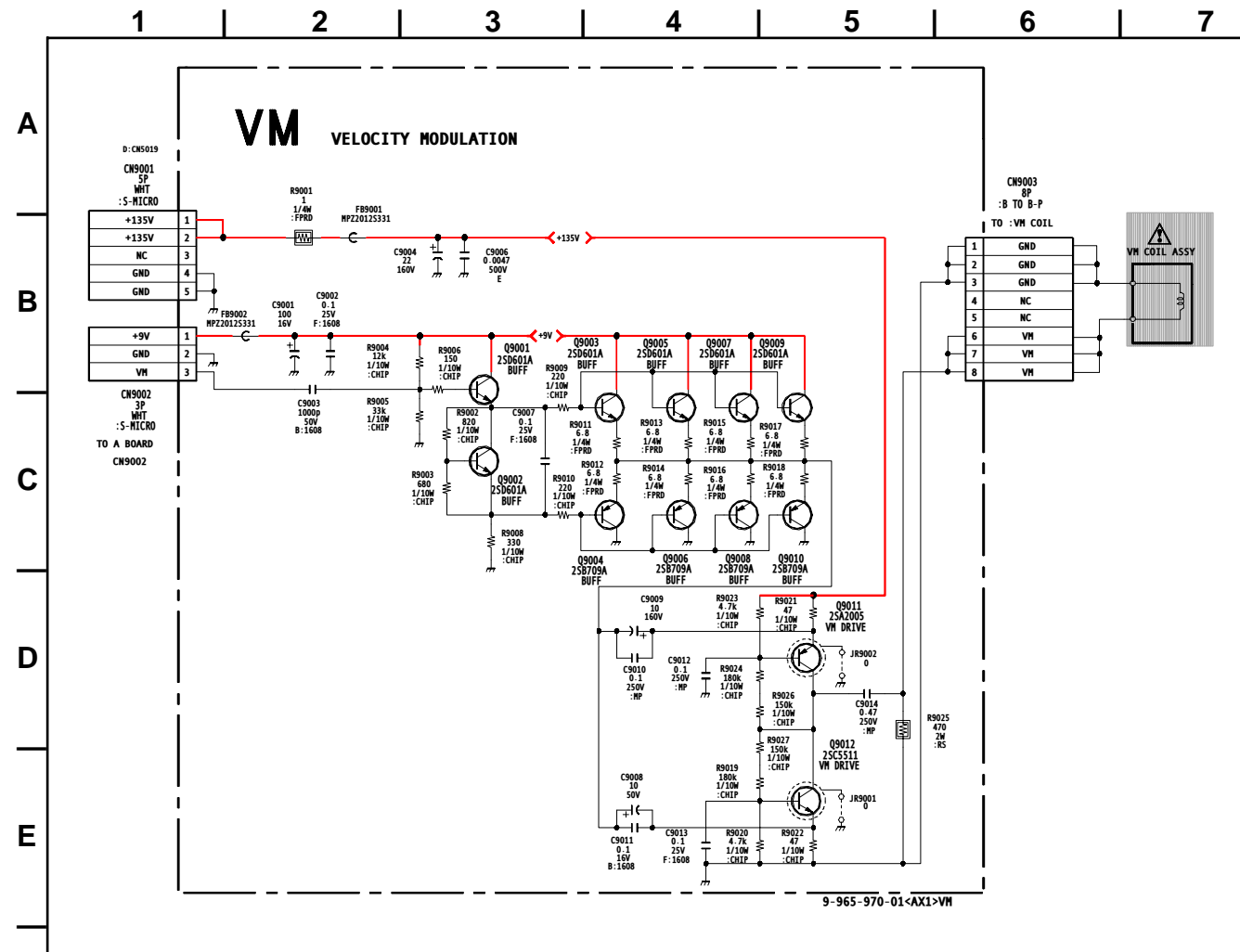

VM BOARD TRANSISTOR VOLTAGE LIST

	B	C	E
Q9001	0.0	9.0	5.2
Q9002	3.6	5.2	4.5
Q9003	5.1	9.0	4.5
Q9004	3.6	GND	4.3
Q9005	5.1	9.0	4.5
Q9006	3.6	GND	4.3
Q9007	5.1	9.0	4.5
Q9008	3.6	GND	4.3
Q9009	5.1	9.0	4.5
Q9010	3.6	GND	4.3
Q9011	133	66.7	134
Q9012	0	66.7	0

VM [VELOCITY MODULATION] COMPONENT SIDE

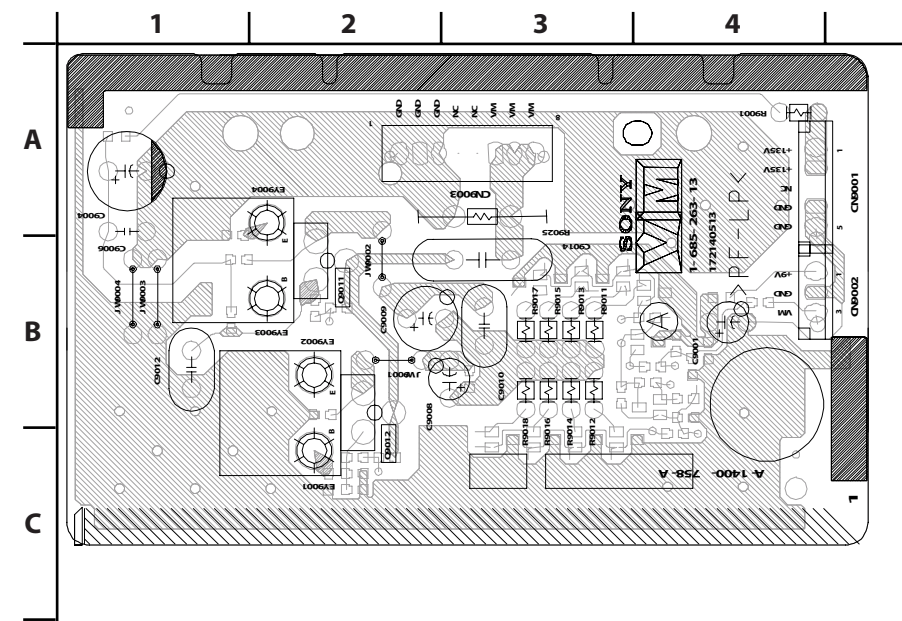

VM [VELOCITY MODULATION] CONDUCTOR SIDE

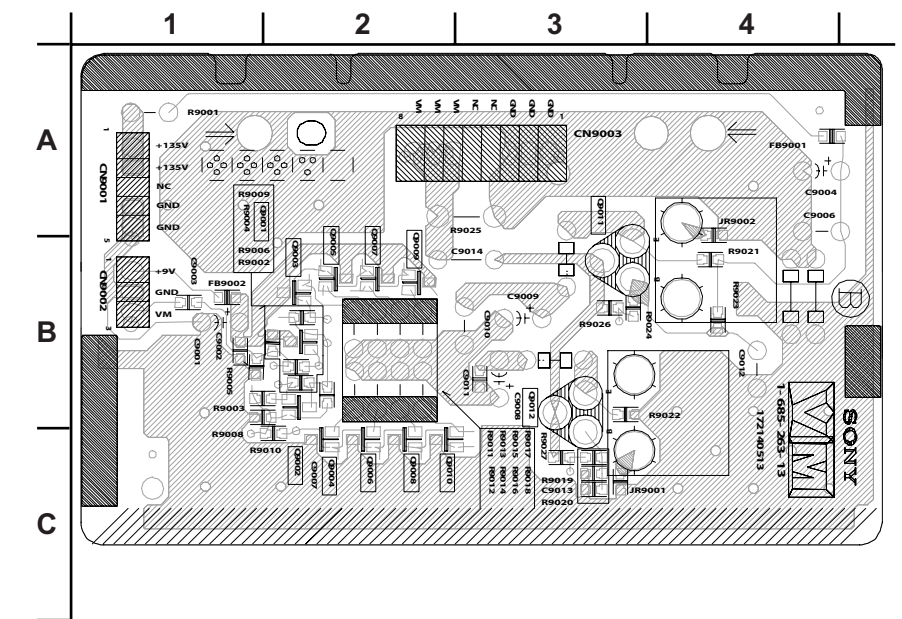

A BOARD SCHEMATIC DIAGRAM (1 OF 6)

A BOARD WAVEFORMS

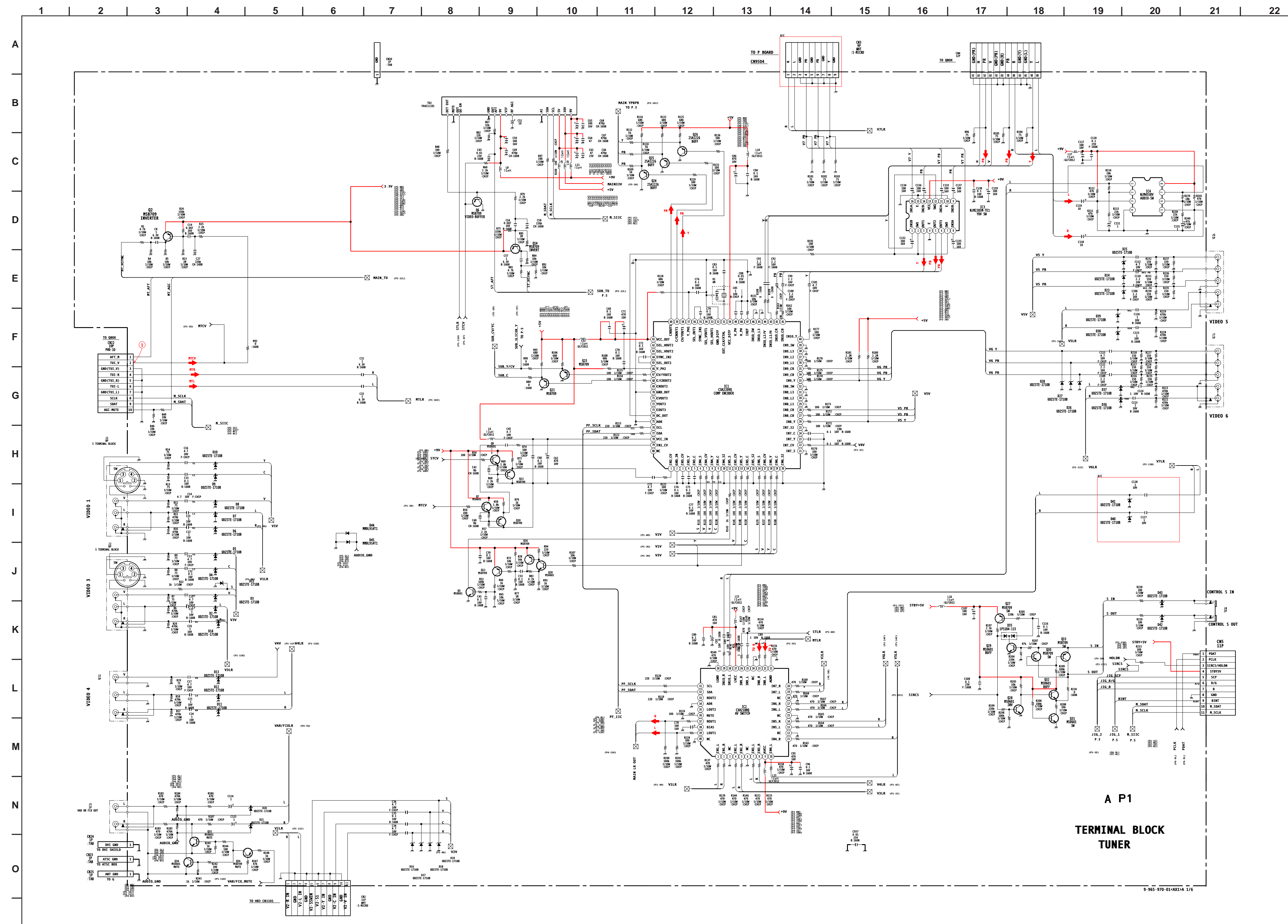
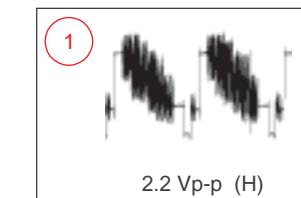

A BOARD SCHEMATIC DIAGRAM (2 OF 6)

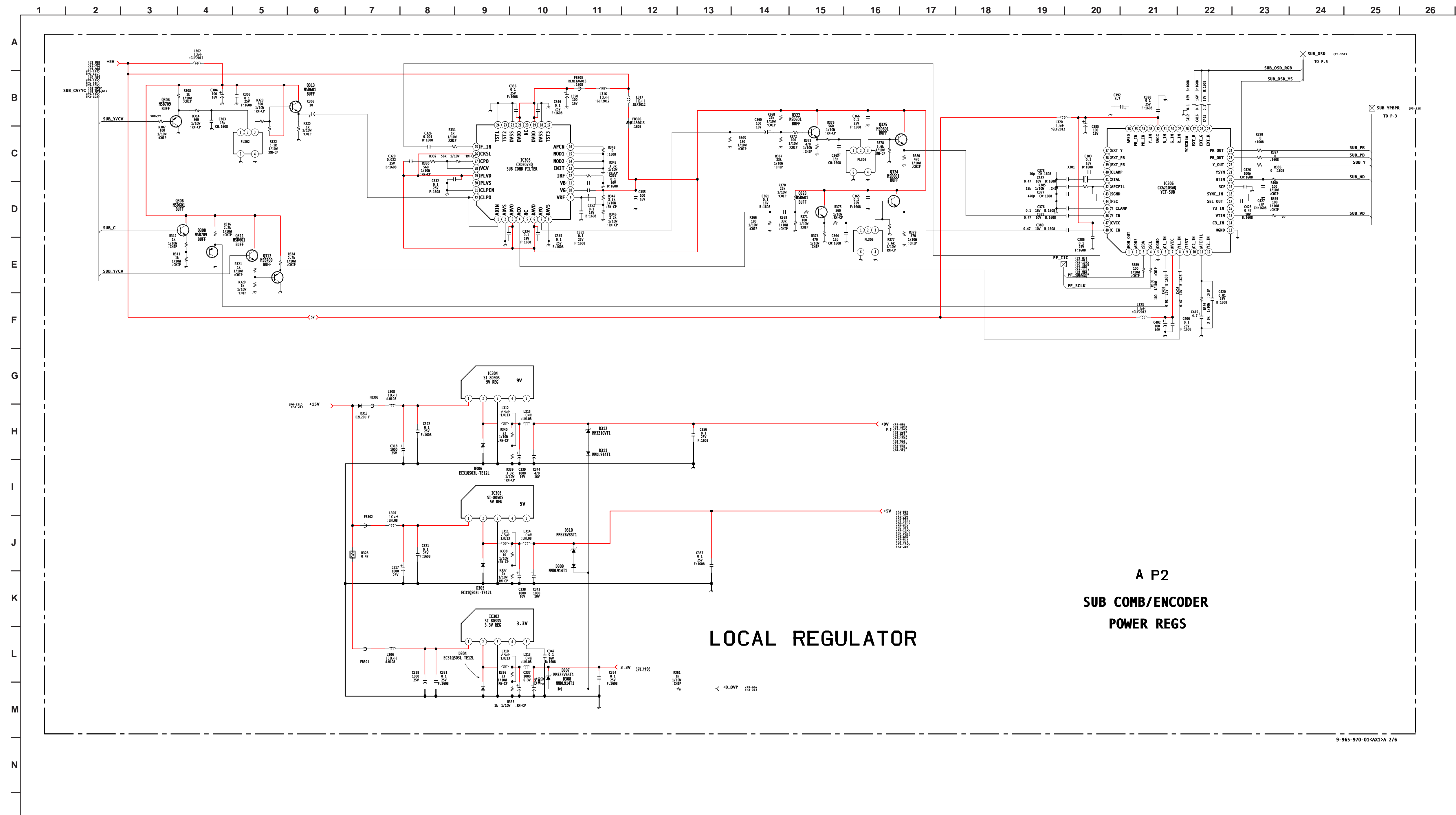

9-965-970-01<AX1>A 2/6

A BOARD SCHEMATIC DIAGRAM (3 OF 6)

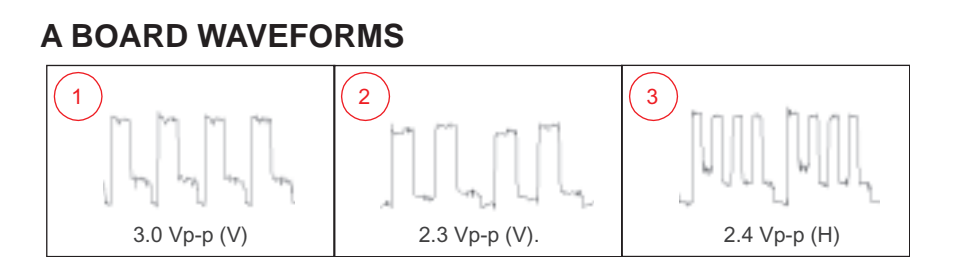
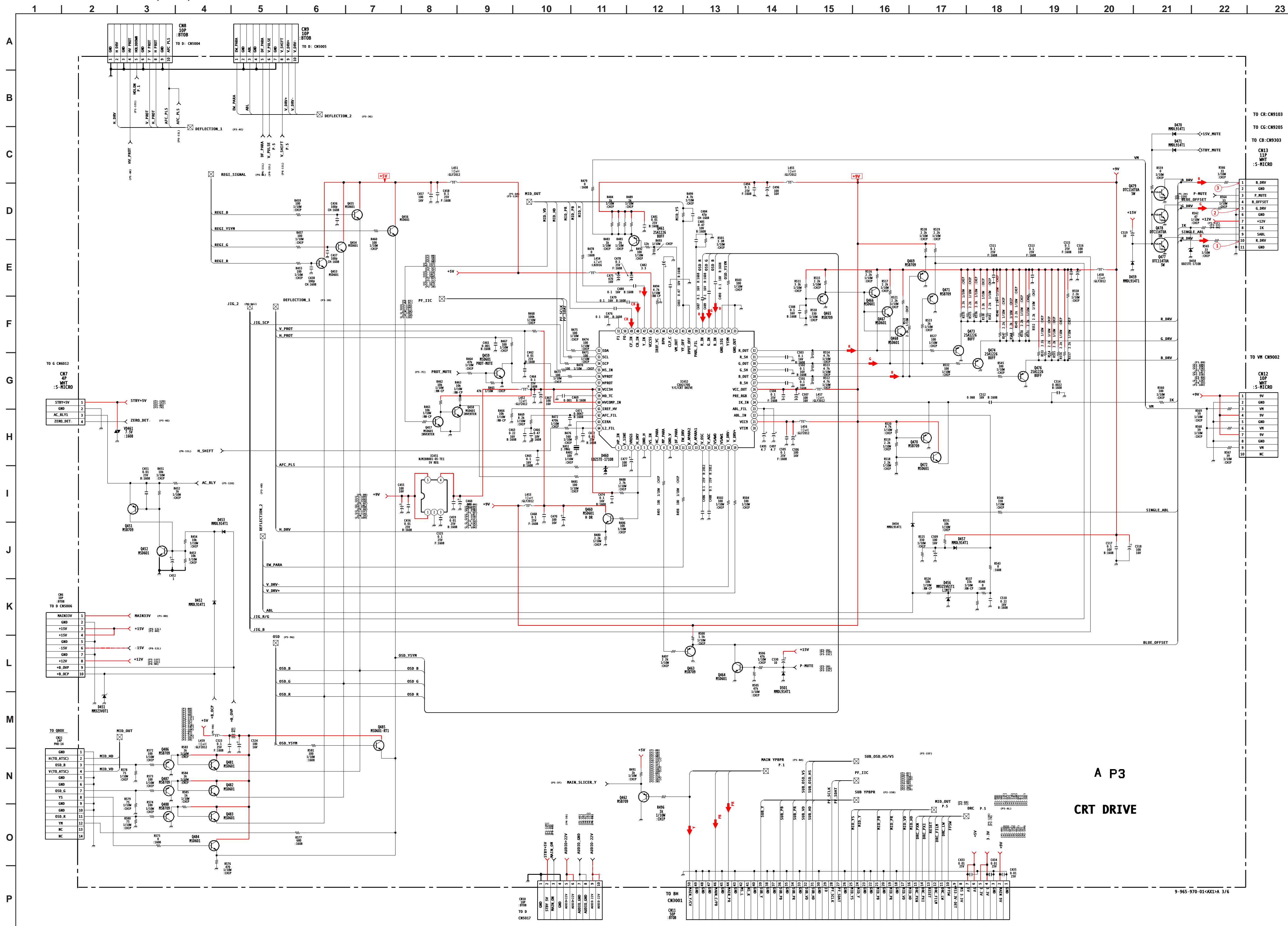

A P3
CRT DRIVE

9-965-970-01-AK1A 3/6

A BOARD SCHEMATIC DIAGRAM (4 OF 6)

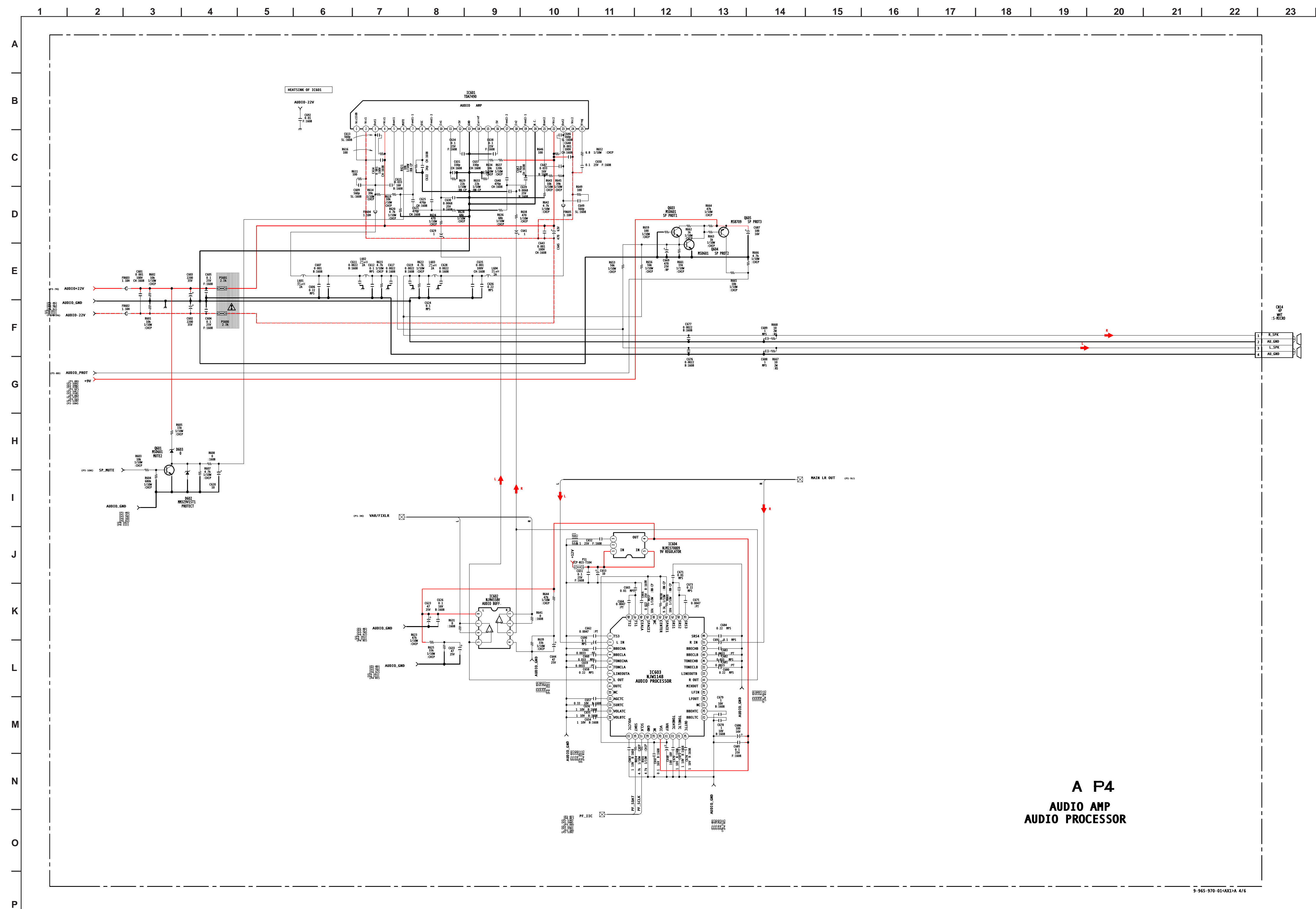

A P4
AUDIO AMP
AUDIO PROCESSOR

A BOARD SCHEMATIC DIAGRAM (5 OF 6)

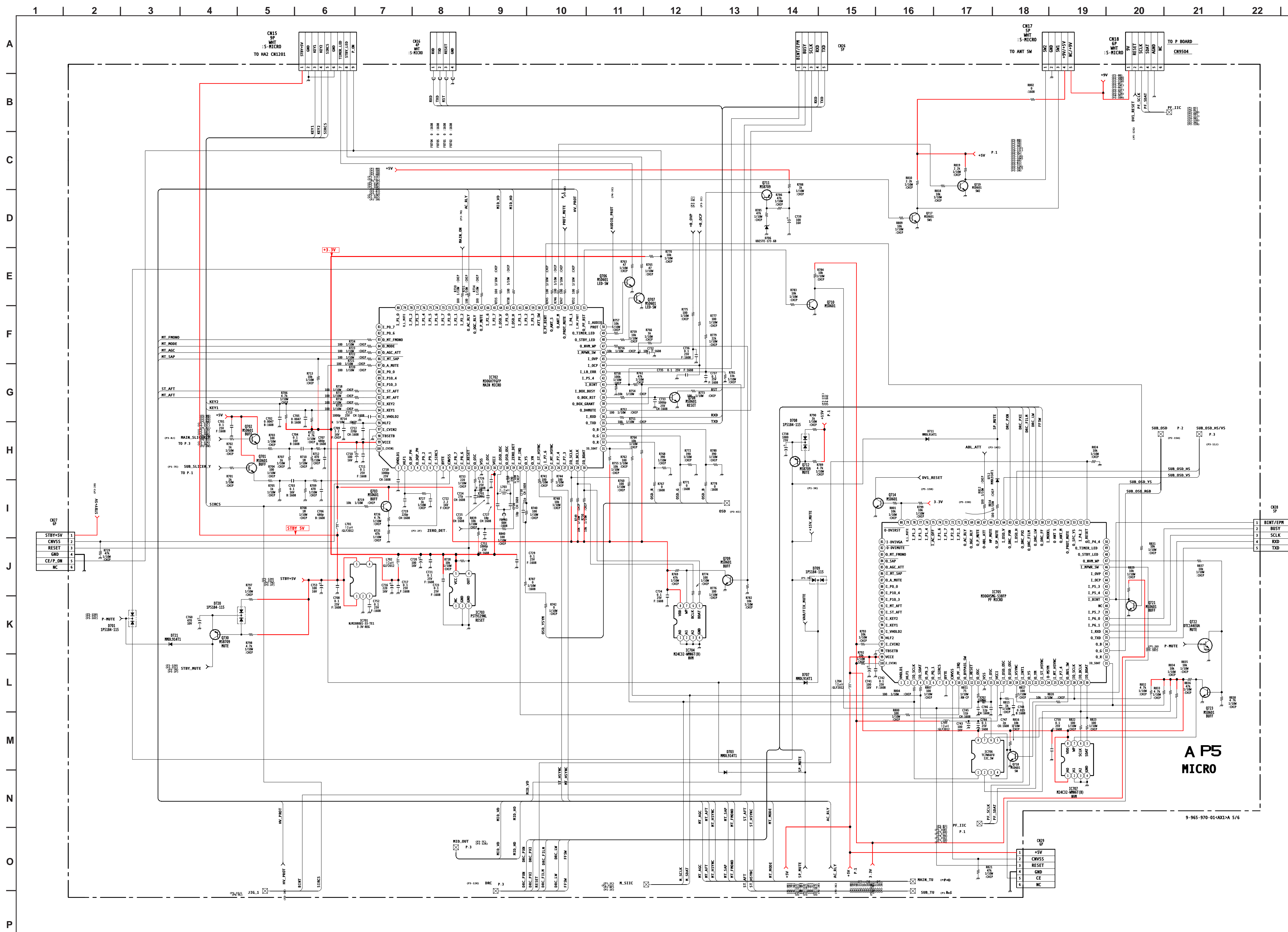

A BOARD SCHEMATIC DIAGRAM (6 OF 6)

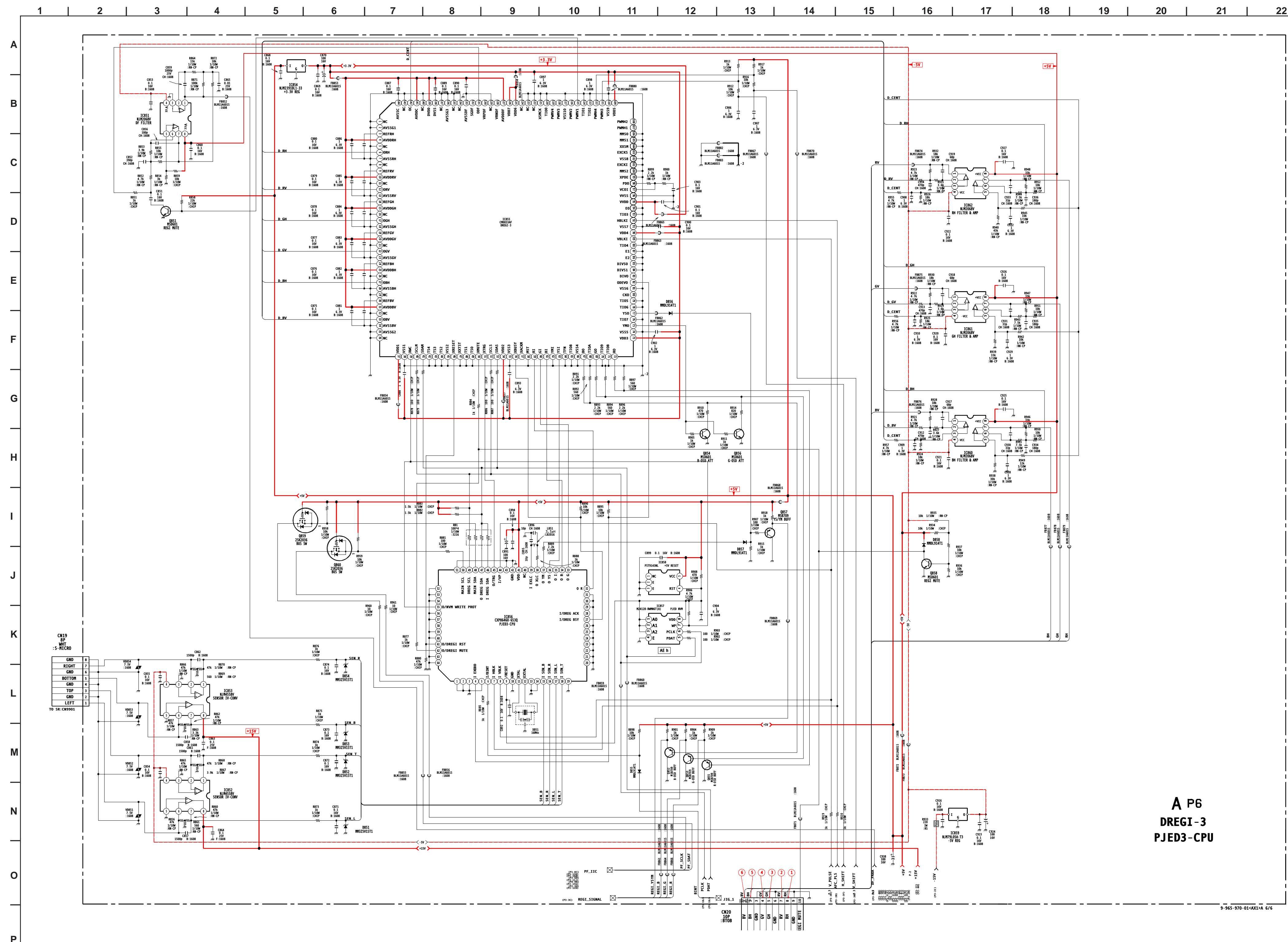

A BOARD WAVEFORMS

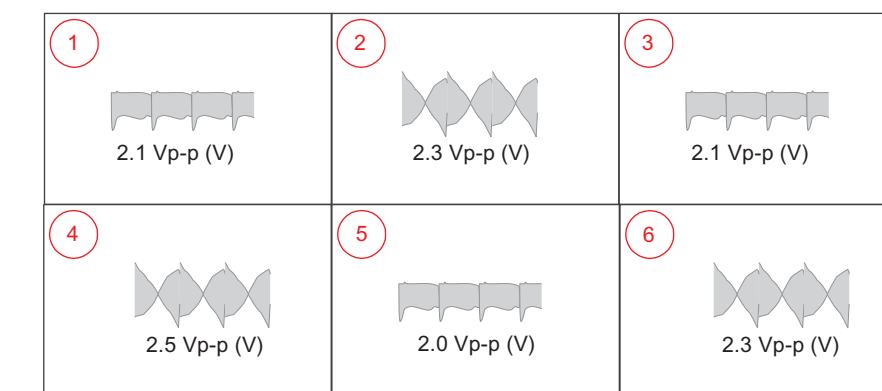

A P6
DREGI-3
PJED3-CPU

9-965-970-01(A)1-A 6/6

A BOARD IC VOLTAGE LIST

IC1	46	GND	11	4.5	16	4.7	14	GND	27	3.4	17	N/C	64	2.7	8	0.0	5	11.0	1	5.0	13	GND	60	0.0	107	N/C	8	0.0	55	5.0	4	-5.0		
PIN	VOLT	47	1.1	12	GND	IC4	15	GND	28	GND	18	1.1	IC601	9	N/C	IC701	2	2.2	14	2.2	61	0.0	108	N/C	9	0.0	56	GND	5	1.8				
1	2.4	48	0.0	13	4.5	PIN	VOLT	16	GND	29	NC	19	4.9	PIN	VOLT	10	N/C	PIN	VOLT	3	GND	15	3.3	62	GND	109	3.3	10	GND	57	GND	6	1.8	
2	GND	49	0.0	14	4.5	1	4.5	17	NC	30	NC	20	N/C	1	-22.00	11	1.4	1	5.0	4	1.1	16	GND	63	0.0	110	GND	11	2.2	58	N/C	7	0.0	
3	2.0	50	5.0	15	GND	2	0.0	18	GND	31	NC	21	9.0	2	-22.00	12	0.8	2	GND	5	1.3	17	1.7	64	GND	111	0.4	12	2.1	59	GND	8	5.0	
4	0.0	51	0.0	16	5.2	3	4.5	19	5.0	32	5.0	22	3.4	3	0.0	13	2.9	3	3.3	6	0.0	18	GND	65	GND	112	1.2	13	GND	60	GND	IC862		
5	0.0	52	0.0	17	0.0	4	GND	20	NC	33	NC	23	5.0	4	22.1	14	2.9	4	3.3	7	0.0	19	2.2	66	GND	113	GND	14	GND	61	5.0	PIN	VOLT	
6	0.0	53	NC	18	GND	5	4.5	21	5.0	34	NC	24	0.0	5	9.1	15	2.8	5	5.0	8	-5.0	20	3.3	67	0.0	114	GND	15	2.0	62	5.0	1	2.8	
7	2.0	54	NC	19	4.5	6	4.5	22	GND	35	NC	25	N/C	6	5.1	16	4.6	IC703		IC852	21	GND	68	GND	115	0.0	16	0.5	63	GND	2	2.7		
8	0.0	55	0.0	20	4.5	7	0.0	23	NC	36	2.6	26	9.0	7	0.0	17	0	PIN	VOLT	PIN	VOLT	22	1.7	69	GND	116	N/C	17	5	64	GND	3	2.6	
9	0.0	56	0.0	21	GND	8	9.0	24	GND	37	NC	27	0.9	8	2.7	18	GND	1	N/C	1	15.0	23	GND	70	GND	117	GND	18	1.7	IC857		4	-5.0	
10	GND	57	2.9	22	0.0	IC302	25	2.4	38	NC	28	0.3	9	0.0	19	N/C	2	GND	2	2.2	24	2.2	71	GND	118	N/C	19	GND	PIN	VOLT	5	1.8		
11	0.0	58	0.0	23	0.0	PIN	VOLT	26	5.0	39	NC	29	5.0	10	0.0	20	9.0	3	GND	3	GND	25	3.3	72	0.0	119	N/C	20	GND	1	4.9	6	1.8	
12	0.0	59	0.0	24	GND	1	15.0	27	2.2	40	1.7	30	5.7	11	0.0	21	4.3	4	3.3	4	0.0	26	GND	73	3.3	120	GND	21	GND	2	4.9	7	0.0	
13	0.0	60	2.4	25	4.5	2	3.3	28	2.2	41	1.7	31	1.3	12	5.3	22	3.3	5	3.3	5	0.5	27	1.7	74	GND	121	GND	22	GND	3	4.9	8	5.0	
14	2.5	61	5.0	26	4.5	3	GND	29	5.0	42	2.4	32	3.1	13	GND	23	3.3	IC704		6	0.0	28	GND	75	0.0	122	GND	23	GND	4	GND			
15	0.0	62	NC	27	9.0	4	3.3	30	GND	43	GND	33	GND	14	-20.7	24	4.9	PIN	VOLT	7	2.8	29	GND	76	GND	123	GND	24	GND	5	4.6			
16	0.0	63	NC	28	4.5	5	15.0	31	GND	44	0.0	34	0.0	15	0.0	25	0.0	1	GND	8	-5.0	30	2.2	77	0.0	124	GND	25	GND	6	4.7			
17	0	64	2.5	29	4.5	IC303	32	1.0	45	3.1	35	GND	16	-5.5	26	3.3	2	GND	IC853		31	3.3	78	GND	125	3.3	26	GND	7	4.7				
18	2.0	65	1.1	30	GND	PIN	VOLT	IC306	46	2.8	36	2.3	17	0.0	27	N/C	3	GND	PIN	VOLT	32	GND	79	GND	126	3.3	27	0.0	8	4.9				
19	0.0	66	2.9	31	4.8	1	15.0	PIN	VOLT	47	5.0	37	0.0	18	0.0	28	N/C	4	GND	1	15.0	33	1.7	80	N/C	127	3.3	28	N/C	IC858				
20	GND	67	1.3	32	4.7	2	5.0	1	NC	48	3.1	38	2.3	19	0.0	29	N/C	5	4.5	2	2.2	34	GND	81	GND	128	N/C	29	GND	PIN	VOLT			
21	GND	68	2.4	33	4.5	3	GND	2	NC	IC451	39	2.1	20	0.0	30	N/C	6	4.5	3	GND	35	GND	82	2.5	129	GND	30	GND	1	NC				
22	2.0	69	2.4	34	GND	4	5.0	3	4.6	PIN	VOLT	40	2.8	21	9.3	31	4.3	7	4.9	4	0.0	36	GND	83	N/C	130	N/C	31	GND	2	GND			
23	2.0	70	0.0	35	4.5	5	NC	4	4.6	1	9.0	41	0.0	22	22.1	32	N/C	8	5.0	5	0.5	37	3.3	84	GND	131	0.0	32	0.0	3	GND			
24	0.0	71	0.0	36	GND	IC304	5	GND	2	GND	42	0.0	23	0.0	33	4.3	IC706		6	0.0	38	GND	85	GND	132	N/C	33	0.0	4	4.9				
25	GND	72	NC	37	4.5	PIN	VOLT	6	2.8	3	5.0	43	3.3	24	-22.0	34	0	PIN	VOLT	7	2.8	39	4.9	86	GND	133	GND	34	0.0	5	5.0			
26	0.0	73	NC	38	4.5	1	15.0	7	4.9	4	5.0	44	0.0	25	-11.6	35	4.3	1	5.0	8	-5.0	40	1.9	87	GND	134	GND	35	0.0	IC859				
27	0.0	74	0.0	39	4.5	2	9.0	8	2.8	5	9.0	45	4.2	IC602	36	4.3	2	0.0	IC854		41	2.2	88	GND	135	GND	36	0.0	PIN	VOLT				
28	2.5	75	0.0	40	GND	3	GND	9	NC	IC452	46	5.0	PIN	VOLT	37	4.3	3	0.0	PIN	VOLT	42	GND	89	0.0	136	GND	37	0.0	1	-15.0				
29	GND	76	4.8	IC3	4	9.0	10	NC	PIN	VOLT	47	3.8	1	4.8	38	0	4	GND	1	5.0	43	GND	90	3.3	137	GND	38	2.4	0	-5.0				
30	GND	77	4.7	PIN	VOLT	5	NC	11	2.3	1	0.0	48	4.4	2	4.5	39	4.3	5	5.0	0	3.3	44	GND	91	GND	138	GND	39	2.7	6	GND			
31	GND	78	5.0	1	0.0	IC305	12	NC	2	N/C	49	5.2	3	4.5	40	4.3	6	5.0	G	GND	45	GND	92	GND	139	GND	40	N/C	IC860					
32	GND	79	2.4	2	0.0	PIN	VOLT	13	GND	3	0.0	50	N/C	4	GND	41	0	7	0.0	IC855		46	5.0	93	GND	140	GND	41	5.0	PIN	VOLT			
33	2.0	80	NC	3	0.0	1	1.0	14	NC	4	3.1	51	GND	5	4.6	42	4.3	8	5.0	PIN	VOLT	47	GND	94	GND	141	3.3	42	GND	1	2.8			
34	2.5	IC2	4	GND	2	GND	15	0.5	5	GND	52	3.4	6	4.5	43	4.3	IC707		1	GND	48	GND	95	3.3	142	1.6	43	GND	2	2.7				
35	2.5	PIN	VOLT	5	0.0	3	4.8	16	NC	6	3.1	53	3.4	7	4.8	44	N/C	PIN	VOLT	2	GND	49	GND	96	GND	143	GND	44	0.0	3	2.6			
36	GND	1	4.5	6	0.0	4	1.0	17	2	7	N/C	54	0.6	8	9.0	45	4.3	1	5.0	3	2.2	50	4.3	97	1.6	144	GND	45	0.0	4	-5.0			
37	GND	2	GND	7	0.0	5	NC	18	3.1	8	3.6	55	8.9	IC603	46	4.3	2	GND	4	3.3	51	0.0	98	1.6	IC856		46	2.2	5	1.8				
38	GND	3	0.0	8	0.0	6	4.8	19	2.0	9	GND	56	4.3	PIN	VOLT	47	4.3	3	GND	5	GND	52	2.5	99	GND	PIN	VOLT	47	2.3	6	1.8			
39	GND	4	4.5	9	0.0	7	0.5	20	0.5	10	N/C	57	4.9	1	4.3	48	4.3	4	GND	6	1.7	53	2.5	100	GND	1	GND	48	4.3	7	0.0			
40	2.1	5	4.5	10	GND	8	GND	21	0.0	11	0.0	58	3.7	2	4.3	IC604		5	4.4	7	GND	54	3.3	101	GND	2	GND	49	2.3	8	5.0			
41	2.5	6	GND	11	4.7	9	1.9	22	1.8	12	N/C	59	1.5	3	0.0	PIN	VOLT	6	0.0	8	GND	55	GND	102	GND	3	GND	50	4.4	IC861				
42	0.0	7	4.5	12	0.0	10	2.6	23	2.1	13	N/C	60	1.5	4	4.3	1	11.0	7	4.9	9	2.2	56	0.0	103	GND	4	2.5	51	GND	PIN	VOLT			
43	0.0	8	4.5	13	9.0	11	0.9	24	2.0	14	2.4	61	8.9	5	0.0	2	GND	8	5.0	10	3.3	57	0.0	104	GND	5	GND	52	GND	1	2.8			
44	0.0	9	9.0	14	4.7	12	2.0	25	3.4	15	4.9	62	2.9	6	0.0	3	0.0	IC851		11	GND	58	GND	105	GND	6	5.0	53	GND	2	2.7			
45	GND	10	4.5	15	GND	13	GND	26	3.4	16	N/C	63	2.9	7	4.3	4	9.0	PIN	VOLT	12	1.7	59	0.0	106	GND	7	0.0	54	GND	3	2.6			

All voltages are in V.

A BOARD TRANSISTOR VOLTAGE LIST

	B	C	E		B	C	E		B	C	E
Q2	3.5	0.5	3.3	Q324	1.9	5.0	1.2	Q485	0.0	5	0.5
Q5	0.0	0.0	GND	Q325	1.9	5.0	1.2	Q486	0.7	GND	0.0
Q6	2.8	GND	3.5	Q451	2.2	0.0	2.2	Q487	0.7	GND	0.0
Q7	6.5	9.0	3.9	Q452	0.0	2.2	GND	Q488	0.7	GND	0.0
Q9	4.5	9.0	3.9	Q453	0.7	5.0	0.0	Q601	0.0	5.2	GND
Q10	3.3	GND	4.0	Q454	0.7	5.0	0.0	Q603	0.0	9.0	0.0
Q12	0.0	0.0	9.0	Q455	0.7	5.0	0.0	Q604	0.0	9.0	GND
Q13	2.0	GND	2.7	Q456	1.1	5.0	0.5	Q605	9.0	0.0	9.0
Q14	3.4	0.0	3.3	Q457	0.0	0.6	GND	Q701	0.0	5.0	0.0
Q16	8.8	9.0	9.0	Q458	0.6	0.0	GND	Q702	0.0	5.0	0.0
Q20	0.0	8.8	0.0	Q459	0.0	0.0	GND	Q703	0.0	5.0	0.0
Q21	2.3	GND	3.0	Q460	2.8	9.0	2.8	Q706	0.0	0.0	GND
Q23	1.2	GND	1.9	Q461	2.4	0.0	3.2	Q707	0.0	0.0	GND
Q24	0.0	GND	3.0	Q462	2.7	GND	2.0	Q709	0.0	4.9	GND
Q25	2.0	GND	3.1	Q463	2.9	GND	3.6	Q710	0.0	3.4	GND
Q26	1.5	GND	2.3	Q464	0.0	3.6	GND	Q711	4.3	4.9	4.9
Q27	4.9	4.2	5.0	Q465	0.8	GND	1.5	Q712	12.1	12.0	12.1
Q28	0.6	0.1	GND	Q466	1.5	8.7	1.9	Q714	3.3	0.0	GND
Q29	0.0	4.9	GND	Q467	1.5	8.7	1.9	Q717	0.0	0.0	GND
Q30	5.0	0.0	0.0	Q468	1.5	8.7	1.6	Q718	0.7	0.0	GND
Q31	0.6	0.0	GND	Q469	1.4	GND	2.0	Q719	0.0	0.0	GND
Q32	0.1	5.0	0.0	Q470	4.4	GND	4.0	Q721	0.0	0.0	GND
Q33	5.0	0.0	0.0	Q471	1.7	GND	2.3	Q722	0.0	0.0	GND
Q34	0.0	0.0	GND	Q472	2.2	9.0	4.0	Q723	0.0	4.9	GND
Q35	0.0	0.0	GND	Q473	1.9	0.0	2.7	Q851	0.0	0.2	GND
Q36	0.0	0.0	0.0	Q474	1.9	GND	0.0	Q852	0.0	GND	0.7
Q304	1.9	GND	0.0	Q476	1.6	GND	2.6	Q853	0.0	GND	0.0
Q306	1.9	5.0	0.0	Q477	0.0	2.5	GND	Q854	0.0	0.0	GND
Q308	1.2	GND	1.9	Q478	0.0	2.5	GND	Q855	0.0	GND	0.7
Q311	2.1	5.0	1.5	Q479	0.0	2.5	GND	Q856	0.0	0.0	GND
Q312	0.7	GND	1.3	Q481	0.0	5.0	0.0	Q857	0.5	GND	1.1
Q313	3.2	5.0	2.6	Q482	0.0	5.0	0.0	Q858	0.0	4.3	GND
Q322	2.7	5.0	2.1	Q483	0.0	5.0	0.0				
Q323	2.7	5.0	0.0	Q484	0.0	5.0	0.5				

All voltages are in V.

A BOARD LOCATOR LIST COMPONENT SIDE

DIODE		IC		TRANSISTOR		TRANSISTOR	
D3	E-13	IC1	E-11	Q16	F-12	Q485	I-5
D7	E-12	IC2	C-11	Q20	F-12	Q486	I-4
D14	E-13	IC3	D-10	Q24	F-10	Q601	C-3
D35	G-13	IC4	B-12	Q26	F-10	Q711	E-5
D309	I-3	IC305	F-8	Q27	H-13	Q712	F-3
D310	I-3	IC306	E-6	Q28	G-13	Q714	F-3
D311	I-3	IC451	I-8	Q29	G-13	Q718	G-4
D312	I-3	IC452	G-6	Q304	Q304	Q723	F-5
D313	G-1	IC602	A-5	Q306	E-9	Q851	H-8
D454	H-4	IC603	B-5	Q308	D-9	Q852	H-9
D456	H-4	IC604	B-4	Q311	E-9	Q853	H-9
D457	H-5	IC701	C-5	Q312	D-9	Q854	H-9
D459	I-4	IC702	D-5	Q313	E-9	Q855	H-8
D460	G-6	IC704	E-4	Q322	E-8	Q856	H-8
D470	F-3	IC705	F-4	Q323	D-7	Q857	G-10
D471	F-3	IC706	F-4	Q324	E-7	Q858	I-12
D501	G-5	IC707	F-5	Q325	E-7		
D602	C-3	IC851	I-8	Q453	I-6		
D603	C-3	IC852	H-12	Q454	I-6		
D703	C-4	IC853	H-12	Q455	I-5		
D706	F-5	IC854	H-8	Q456	I-5		
D708	F-3	IC855	G-9	Q457	I-7		
D709	F-3	IC856	H-11	Q458	I-7		
D711	F-4	IC857	H-10	Q459	H-7		
D721	F-3	IC858	I-11	Q461	I-6		
D851	F-4	IC859	I-13	Q464	G-6		
D852	H-12	IC860	I-10	Q466	I-5		
D853	I-12	IC861	I-10	Q467	H-5		
D854	I-12	IC862	I-8	Q468	H-5		
D855	I-12			Q473	I-5		
D856	G-10			Q474	I-5		
D857	G-10			Q476	H-5		
D858	I-11			Q481	I-10		
				Q482	E-10		

A BOARD LOCATOR LIST CONDUCTOR SIDE

DIODE		IC		TRANSISTOR	
D2	E-1	IC302	H-13	Q703	C-10
D3	E-2	IC303	E-13	Q706	D-8
D4	E-2	IC304	F-13	Q707	D-8
D5	E-2	IC601	C-12	Q708	E-9
D6	F-2	IC703	D-9	Q709	E-9
D8	F-1	TRANSISTOR		Q710	G-11
D9	F-2	Q2	C-6	Q717	C-8
D10	F-2	Q4	B-7	Q719	D-8
D11	E-2	Q5	F-2	Q721	F-8
D12	D-2	Q6	B-7	Q722	F-10
D13	D-2	Q7	G-3	Q730	E-12
D15	E-2	Q9	F-2	Q859	J-2
D16	D-3	Q10	G-2	Q860	J-3
D17	D-3	Q12	F-2		
D18	D-3	Q13	F-2		
D19	D-3	Q14	B-7		
D20	A-1	Q21	F-3		
D21	A-2	Q23	F-3		
D23	C-2	Q25	F-4		
D24	D-2	Q30	G-2		
D25	D-2	Q31	G-1		
D26	C-2	Q32	G-1		
D27	C-2	Q33	G-1		
D28	C-2	Q34	B-1		
D36	C-1	Q35	B-1		
D37	B-2	Q36	A-1		
D38	D-1	Q451	I-11		
D39	C-2	Q452	I-11		
D40	C-4	Q460	G-7		
D41	C-4	Q462	G-3		
D42	F-1	Q463	G-7		
D43	G-2	Q465	I-9		
D44	C-1	Q469	H-9		
D45	C-1	Q470	G-8		
D304	H-12	Q471	H-9		
D305	D-12	Q472	G-8		
D306	F-12	Q477	H-9		
D307	I-11	Q478	H-9		
D308	I-11	Q479	H-9		
D451	I-11	Q483	I-9		
D452	I-11	Q484	I-9		
D453	I-11	Q487	I-10		
D458	H-9	Q488	I-9		
D701	F-11	Q603	A-11		
D707	F-11	Q604	A-11		
D712	F-10	Q605	A-10		
D720	E-12	Q701	D-10		
		Q702	C-11		

A

TERMINAL BLOCK, TUNER
SUB COMB/ENCODER, POWER REGS,
CRT DRIVE, AUDIO AMP, AUDIO PROCESSOR
MICRO, DREGI-3, PJED3-CPU]
COMPONENT SIDE

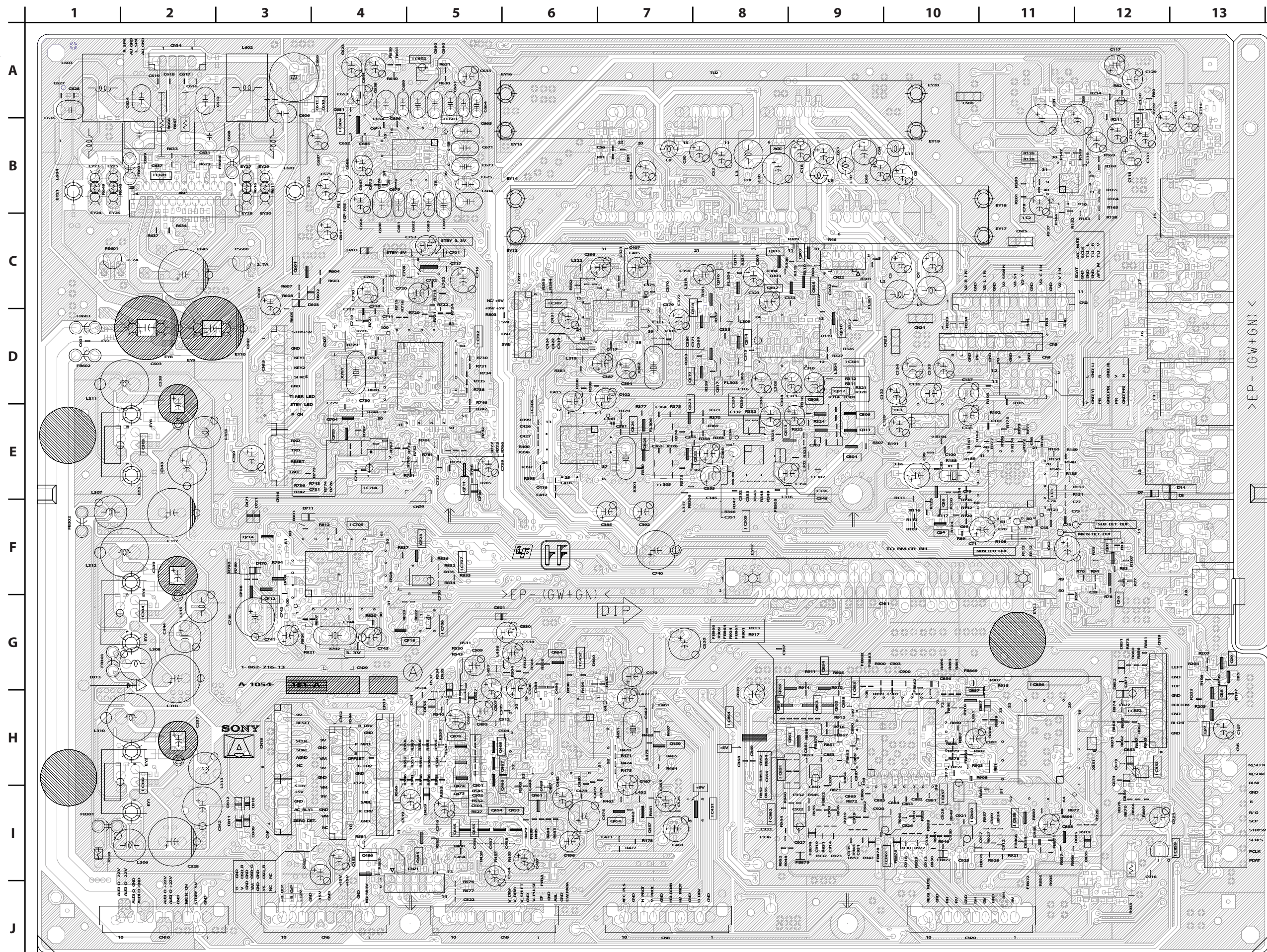

A

TERMINAL BLOCK, TUNER
SUB COMB/ENCODER, POWER REGS,
CRT DRIVE, AUDIO AMP, AUDIO PROCESSOR
MICRO, DREGI-3, PJED3-CPU]
CONDUCTOR SIDE

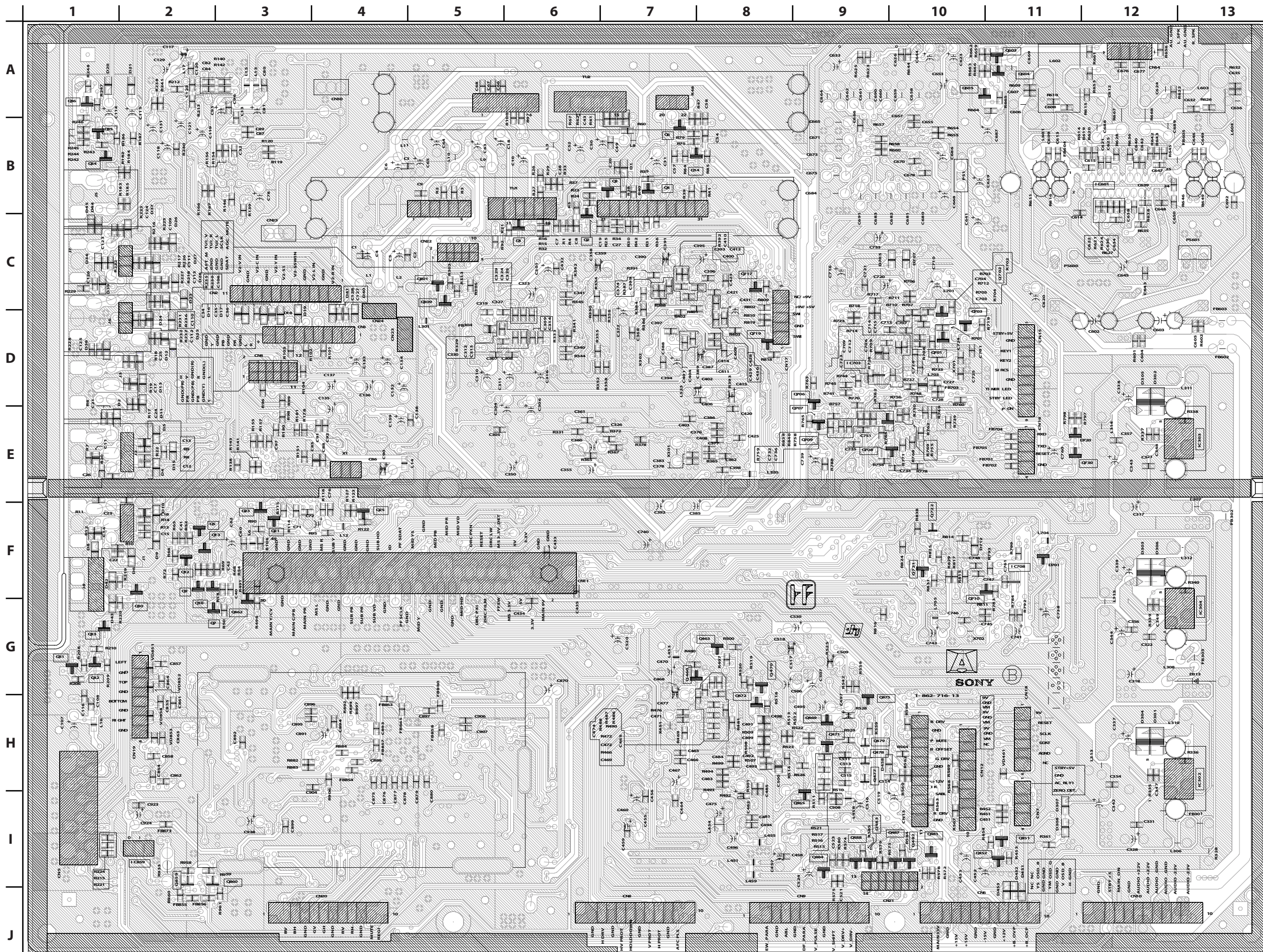

D BOARD SCHEMATIC DIAGRAM (1 OF 2)

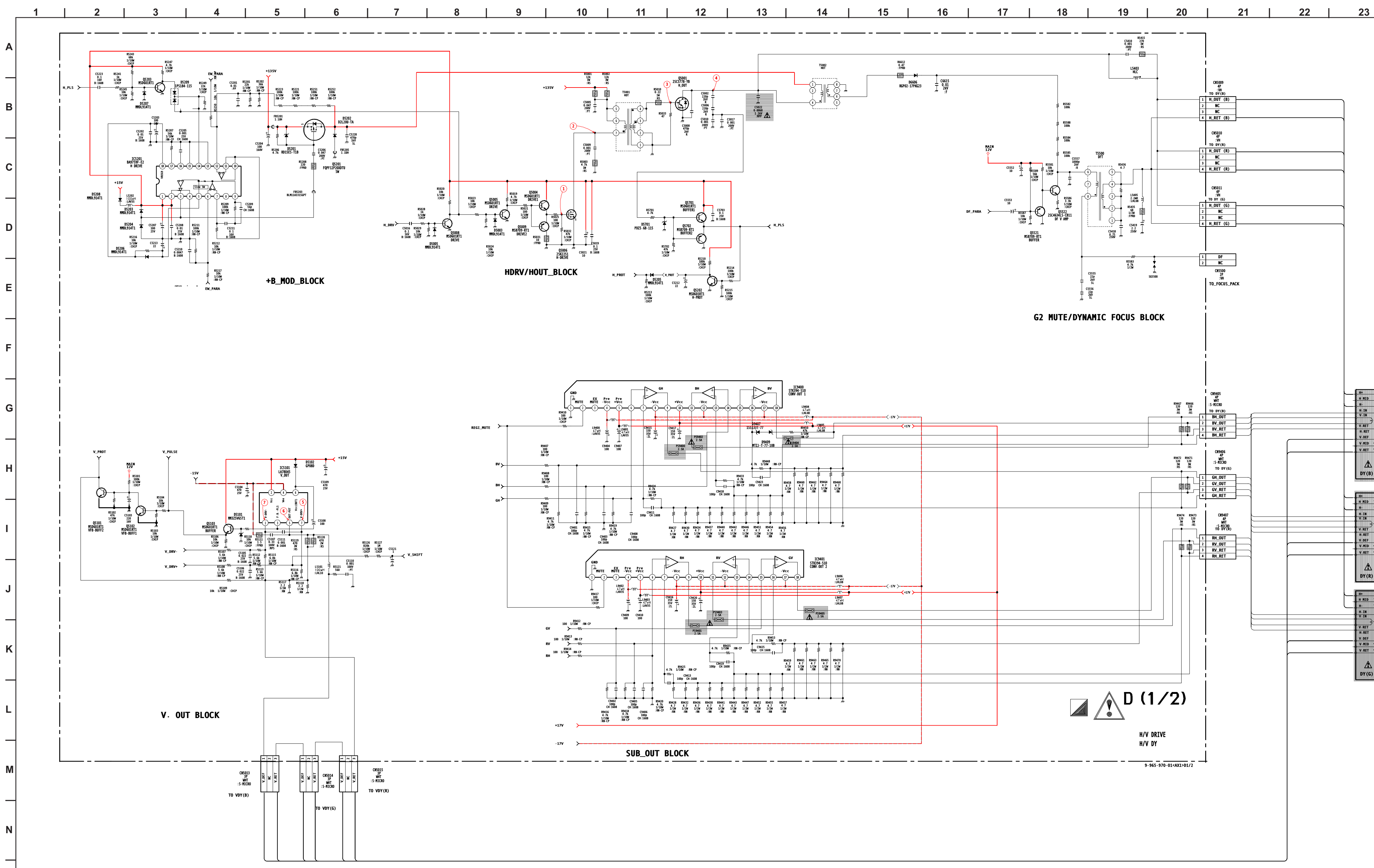

D BOARD IC VOLTAGE LIST

IC5101		IC6400		IC6503		IC8002		IC8005		IC9401	
PIN	VOLT	PIN	VOLT	PIN	VOLT	PIN	VOLT	PIN	VOLT	PIN	VOLT
1	1.2	1	2.8	1	134.0	1	2.8	1	2.5	1	GND
2	15.0	2	1.8	2	N/C	2	1.8	2	GND	2	4.3
3	-13.1	3	2.2	3	N/C	3	2.2	3	9.9	3	N/C
4	-15.0	4	2.5	4	N/C	4	2.5	4	N/C	4	-17.0
5	0.0	5	GND	5	2.5	5	GND	5	GND	5	17.0
6	14.6	6	0.0	6	1	6	0.0	6	2.5	6	-0.1
7	1.2	7	4.6	7	GND	7	4.6	7	GND	7	-0.1
8	17.9	8	17.9	8	12	8	17.9	8	2.5	8	-17.0
9	0.0	9	0.0	9	0.0	9	0.0	9	0.0	9	0.0
10	15.0	10	10.5	10	15.0	10	10.5	10	17.0	10	17.0
11	15.0	11	GND	11	15.0	11	GND	11	GND	11	0.5
12	5.8	12	4.8	12	6.35	12	4.8	12	4.3	12	-17.0
13	GND	13	N/C	13	GND	13	N/C	13	N/C	13	0.3
14	7.9	14	151.8	14	6.35	14	151.8	14	-17.0	14	0.3
15	3.8	15	142.2	15	N/C	15	142.2	15	17.0	15	0
16	3.8	16	146.3	16	146.3	16	146.3	16	-0.3	16	0
17	N/C	17	N/C	17	N/C	17	N/C	17	-0.3	17	-17.0
18	3.9	18	342.0	18	134.0	18	N/C	18	-17.0	18	0.1
19	3.6	19	15.4	19	15.4	19	15.4	19	-0.5	19	-0.5
20	3.6	20	15.0	20	15.0	20	15.0	20	17.0	20	17.0
21	3.6	21	15.0	21	15.0	21	15.0	21	17.0	21	17.0
22	GND	22	GND	22	GND	22	GND	22	GND	22	GND
23	7.1	23	0.1	23	0.1	23	0.1	23	0.0	23	0.0
24	GND	24	GND	24	GND	24	GND	24	0.0	24	0.0
25	3.2	25	2.1	25	2.1	25	2.1	25	0.0	25	0.0
26	2.6	26	GND	26	GND	26	GND	26	16.0	26	16.0
27	2.6	27	2.3	27	2.3	27	2.3	27	17.0	27	17.0
28	9.1	28	2.5	28	2.5	28	2.5	28	18.0	28	18.0
29		29	17.5	29	17.5	29	17.5	29	17.5	29	17.5

All voltages are in V.

D BOARD TRANSISTOR VOLTAGE LIST

	B	C	E		B	C	E
Q5001	0.0	84.3	GND	Q6403	157.0	156.0	GND
Q5004	3.8	12.0	3.8	Q6404	0.0	0.0	GND
Q5005	0.2	3.8	GND	Q6802	15.4	0.0	15.4
Q5008	0.0	2.1	GND	Q6803	133.0	3.7	132.0
Q5009	3.8	0.0	3.8	Q8003	0.1	2.6	GND
Q5101	0.1	0.8	GND	Q8004	0.1	2.6	GND
Q5102	0.0	0.1	GND	Q8007	0.6	0.1	GND
Q5103	0.0	15.0	0.2	Q8008	0.6	0.1	GND
Q5202	0.6	0.0	GND	Q8009	2.6	15.0	2.6
Q5203	0.9	9.0	GND	Q8010	0.6	0.1	GND
Q5406	2.7	76.7	2.7	Q8011	12.0	0.0	12.0
Q5521	14.6	GND	14.6	Q8021	12.0	0.0	12.0
Q5522	3.1	191.6	2.8	Q8028	0.0	11.7	GND
Q5701	7.4	12.0	7.2	Q8034	0.0	12.0	GND
Q5702	7.4	GND	7.2	Q8035	11.6	2.5	12.0
Q6402	5.5	0.0	GND				

All voltages are in V.

	D	G	S
Q5006	64.0	3.8	GND
Q5201	115.0	131.0	135.0
Q6400	306.0	145.0	140.0
Q6401	140.0	4.8	GND
Q8013	136.0	4.5	GND
Q8014	305.0	131.0	136.0

All voltages are in V.

D BOARD WAVEFORMS

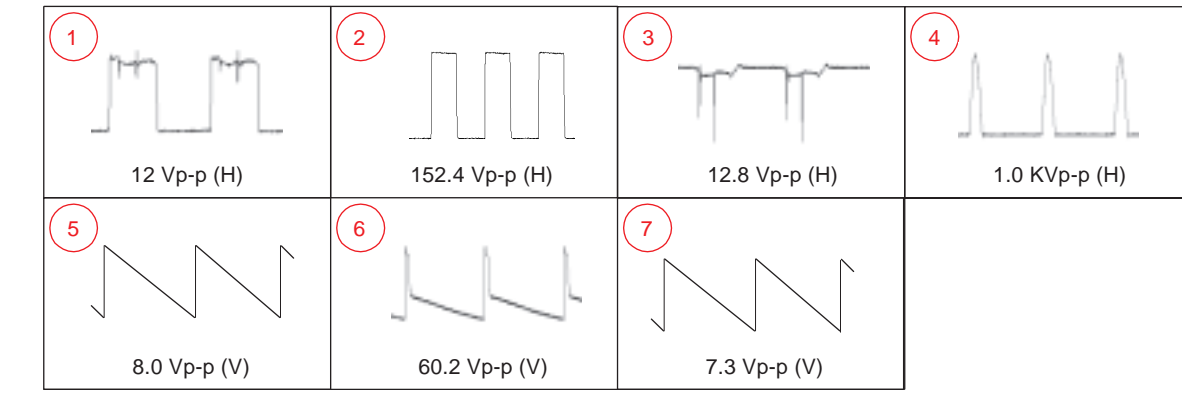

D BOARD SCHEMATIC DIAGRAM (2 OF 2)

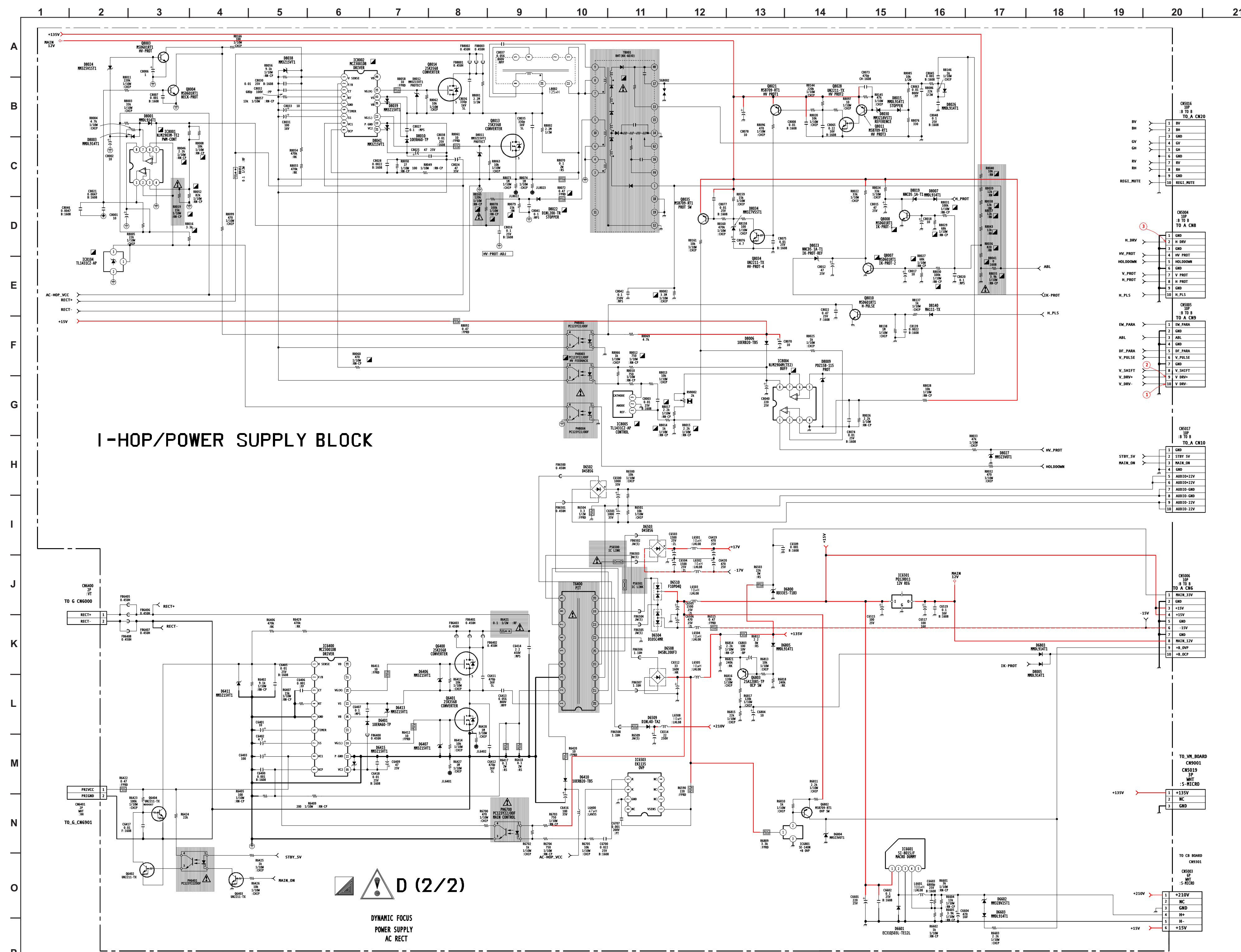

I-HOP/POWER SUPPLY BLOCK

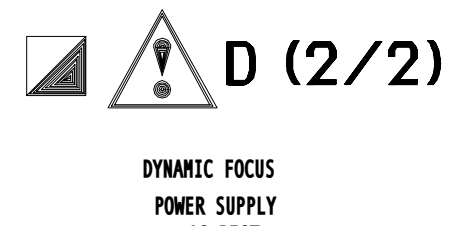

D BOARD WAVEFORMS

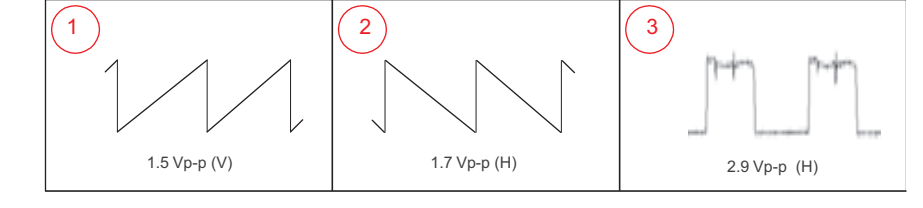

D BOARD LOCATOR LIST CONDUCTOR SIDE

DIODE		DIODE		TRANSISTOR	
D5003	D-10	D8010	C-4	Q5001	F-10
D5005	E-10	D8011	B-4	Q5004	D-10
D5101	G-4	D8012	A-4	Q5005	D-10
D5102	H-5	D8015	C-10	Q5006	E-11
D5201	G-8	D8019	A-10	Q5008	D-10
D5202	G-8	D8022	B-6	Q5009	C-11
D5203	G-7	D8023	B-11	Q5101	I-6
D5204	G-7	D8024	C-6	Q5102	G-4
D5205	F-7	D8026	B-10	Q5103	G-4
D5206	G-7	D8027	D-8	Q5201	G-8
D5207	H-7	D8030	C-10	Q5202	F-7
D5208	G-7	D8034	D-9	Q5203	H-7
D5209	H-8	D8038	C-5	Q5521	I-8
D5701	F-7	D8039	C-5	Q5522	J-8
D6401	C-3	D8041	C-4	Q5701	E-7
D6406	B-2	D8140	D-7	Q5702	F-8
D6407	D-2	D9407	B-12	Q6400	B-1
D6409	D-2	D9409	B-12	Q6401	C-2
D6410	D-3	IC		Q6402	D-4
D6411	C-4	IC5101	H-5	Q6403	E-4
D6413	C-3	IC5201	G-7	Q6404	C-4
D6415	D-3	IC6400	C-4	Q6802	E-6
D6502	G-2	IC6501	J-2	Q6803	F-5
D6503	G-2	IC6503	E-5	Q8003	B-6
D6504	D-3	IC6601	J-1	Q8004	B-4
D6508	E-4	IC6801	E-5	Q8007	A-11
D6509	F-4	IC8001	D-6	Q8008	A-10
D6510	G-3	IC8002	C-5	Q8010	C-7
D6601	J-1	IC8004	D-8	Q8011	C-10
D6602	I-2	IC8005	D-7	Q8013	B-4
D6603	I-2	IC8104	D-5	Q8014	A-4
D6606	H-8	IC9400	B-11	Q8021	D-10
D6800	F-6	IC9401	G-11	Q8028	C-9
D6803	G-5			Q8034	C-9
D6804	E-5			Q8035	C-9
D6805	F-5				
D8001	C-6				
D8003	C-6				
D8005	G-5				
D8006	D-7				
D8007	B-10				
D8009	D-8				



[H/V DRIVE, H/V DY, DYNAMIC FOCUS, POWER SUPPLY, AC RECT]

CONDUCTOR SIDE

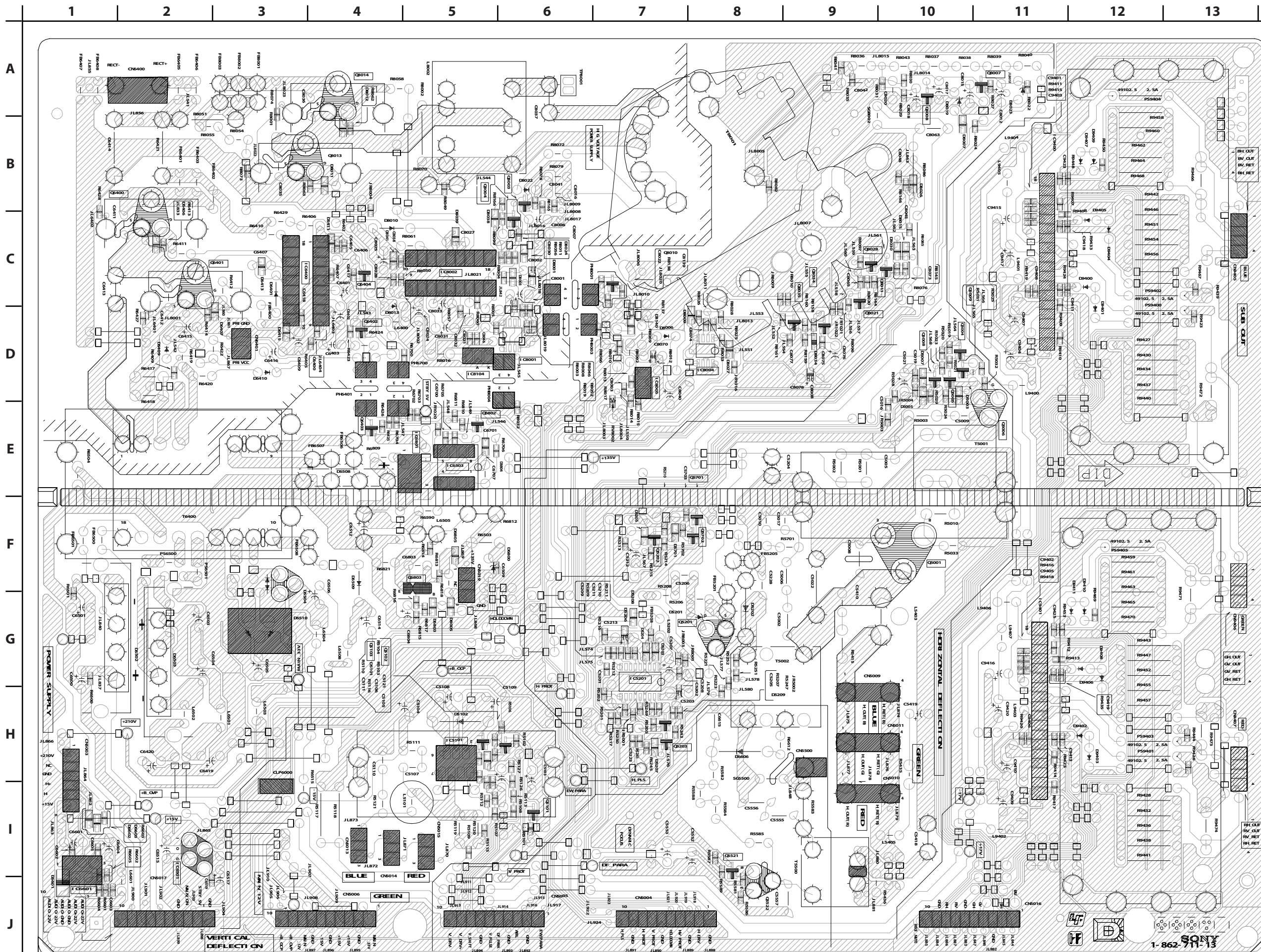

BH BOARD SCHEMATIC DIAGRAM (1 OF 2)

Due to the complexity of this board, performing component level field repairs is not recommended. If service is required, complete board replacement is the preferred repair method. Data is provided for reference only.

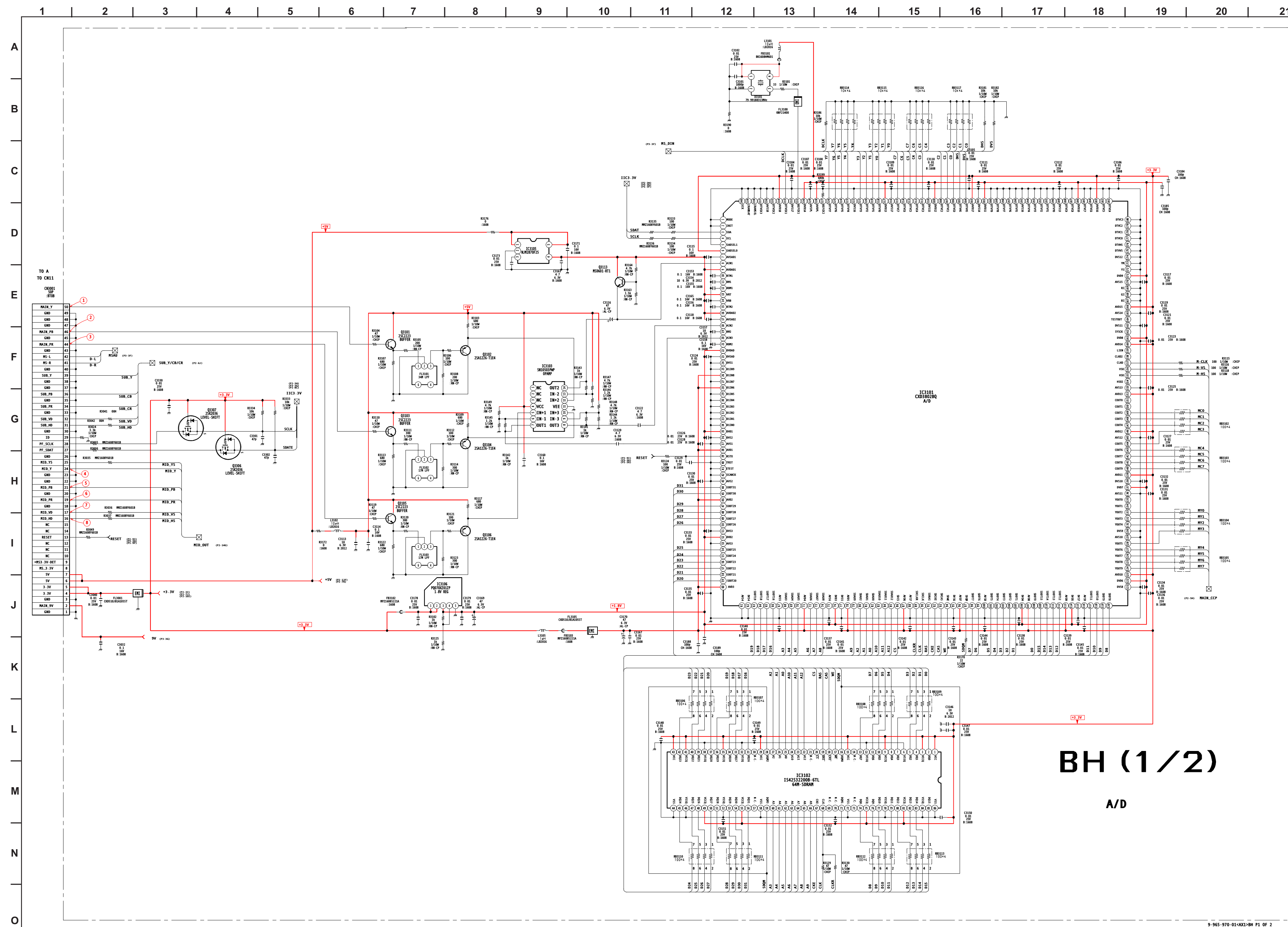

BH BOARD WAVEFORMS

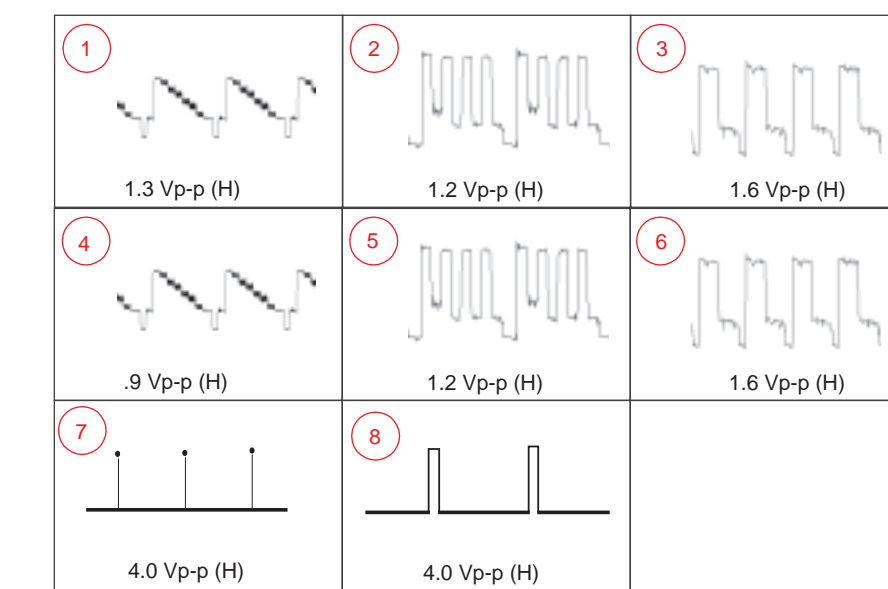

BH (1/2)

A/D

BH BOARD SCHEMATIC DIAGRAM (2 OF 2)

Due to the complexity of this board, performing component level field repairs is not recommended. If service is required, complete board replacement is the preferred repair method. Data is provided for reference only.

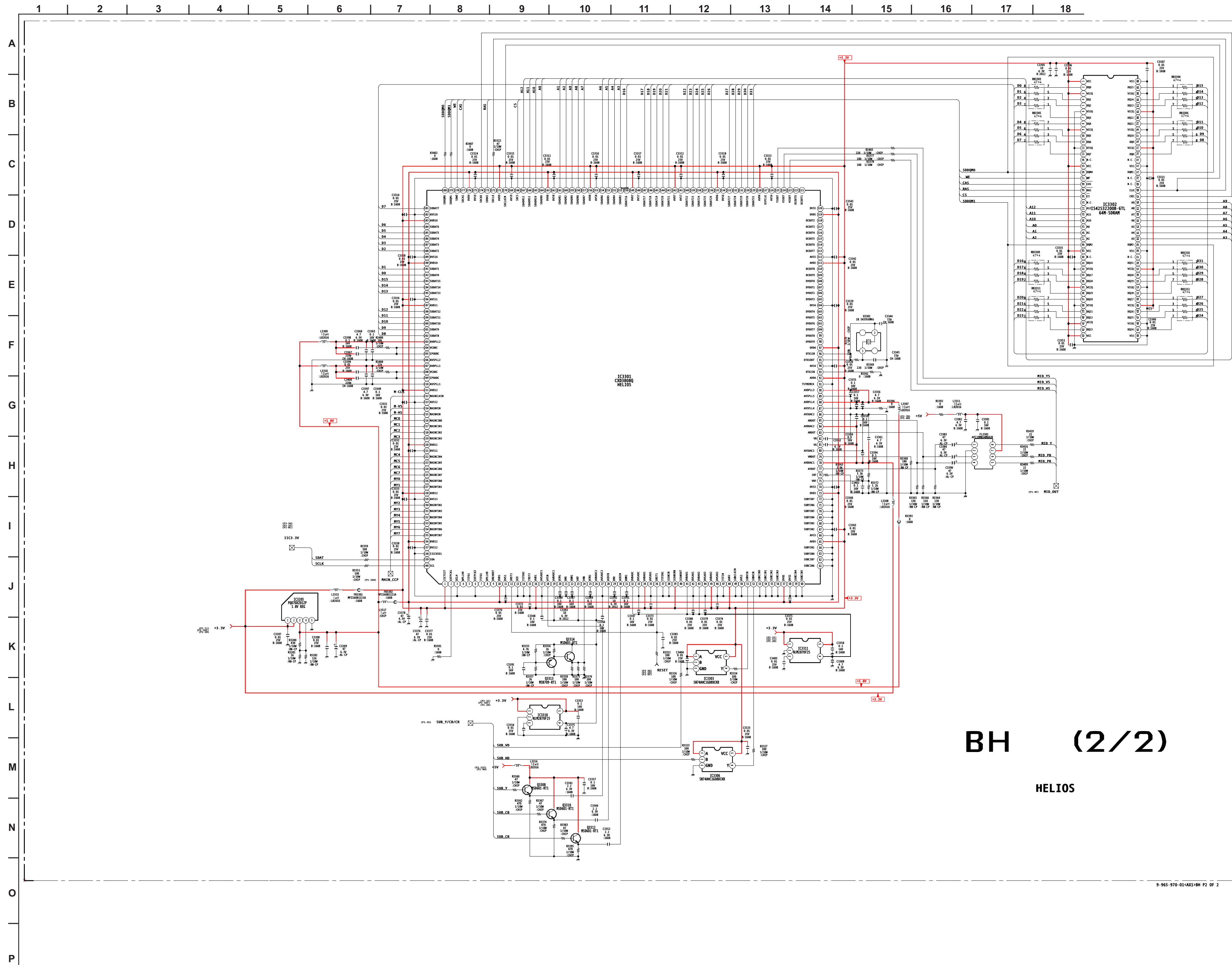

BH (2/2)
HELIOS

9-965-970-01-0013-BH P2 OF 2

NOTE: THE BH BOARDS ARE MANUFACTURED AT DIFFERENT FACILITIES. EITHER BOARD CAN BE USED AS A REPLACEMENT.

BH [A/D, HELIOS] (A-1071-980-A)
COMPONENT SIDE

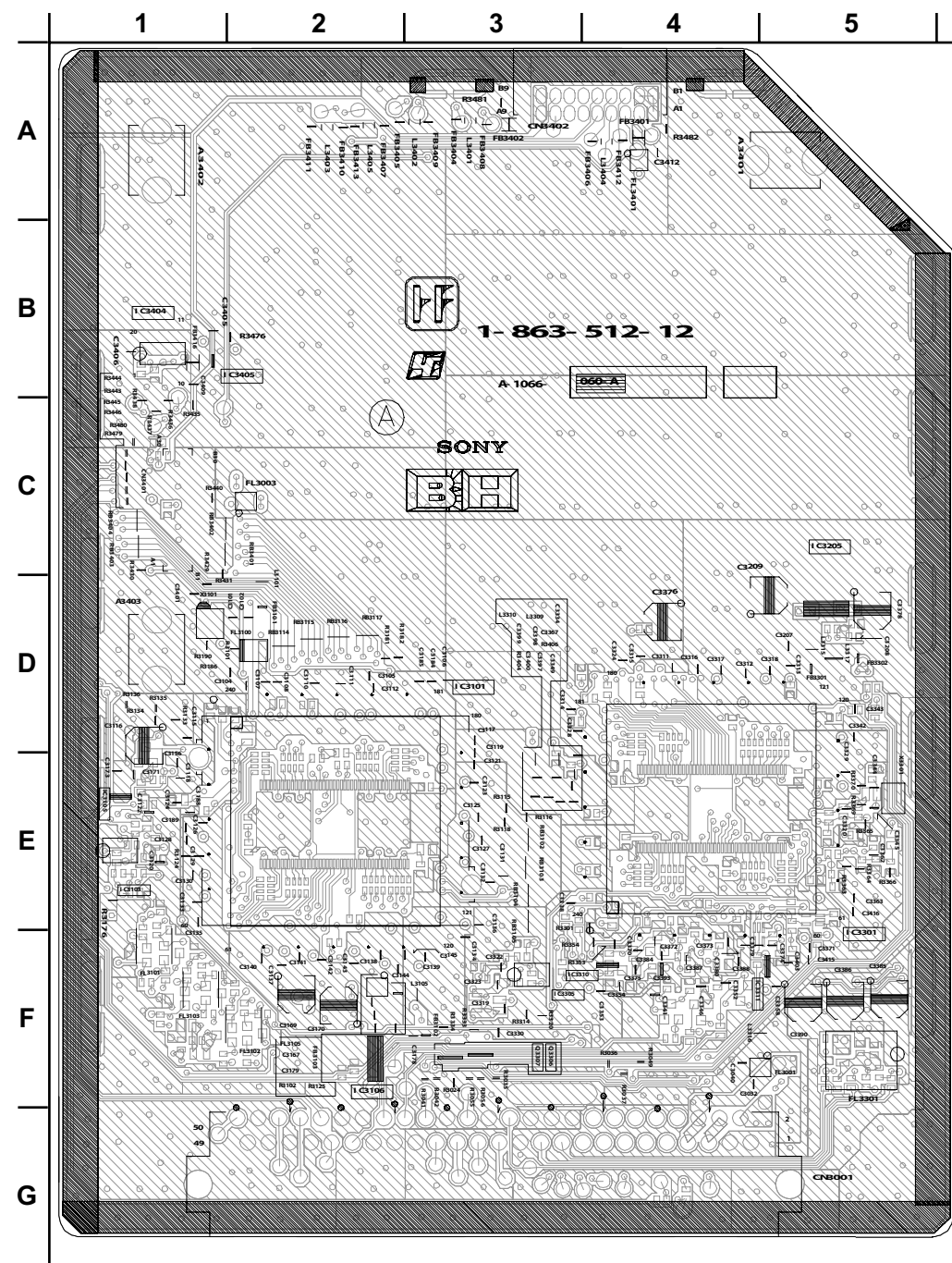

BH [A/D, HELIOS] (A-1071-980-A)
CONDUCTOR SIDE

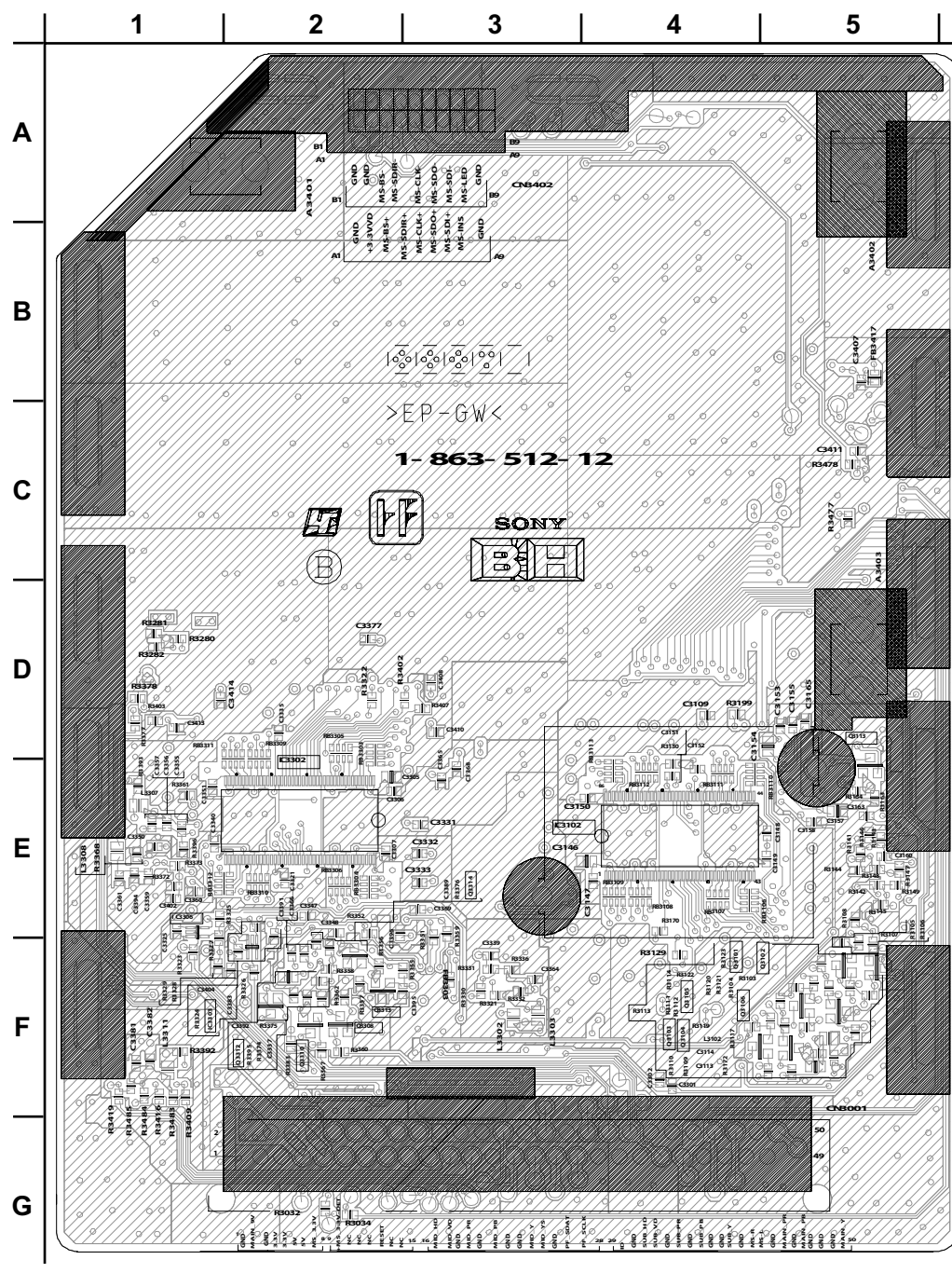

BH [A/D, HELIOS] (PN A-1111-561-A)
COMPONENT SIDE

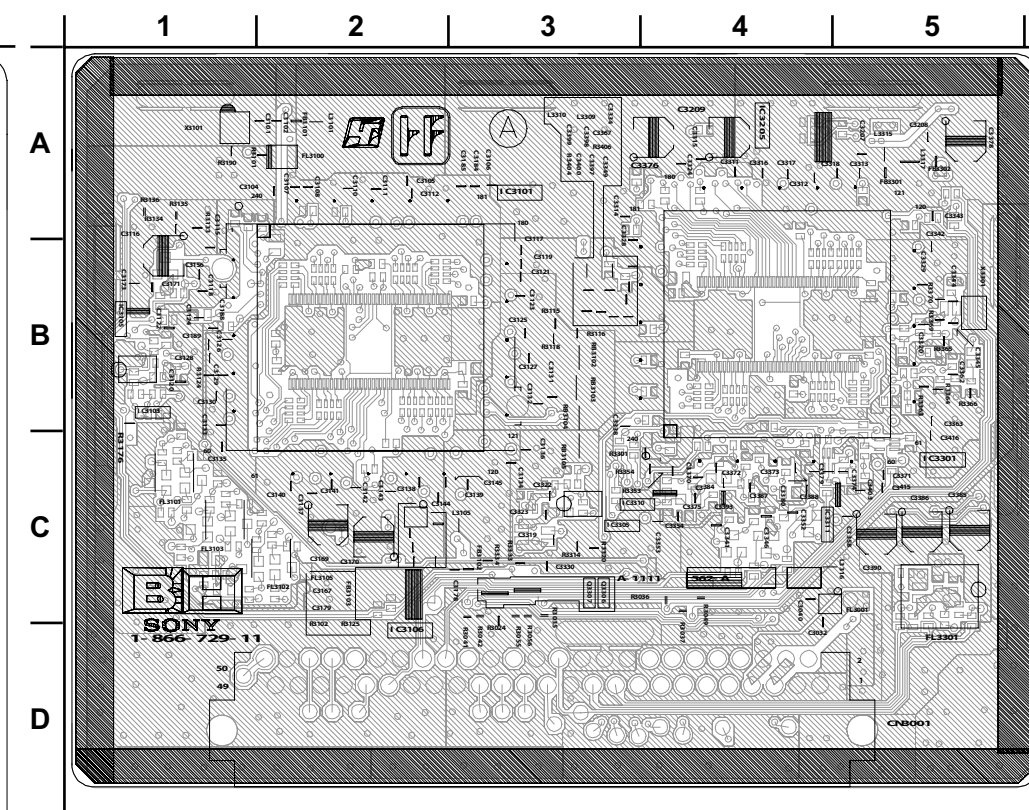

BH [A/D, HELIOS] (PN A-1111-561-A)
CONDUCTOR SIDE

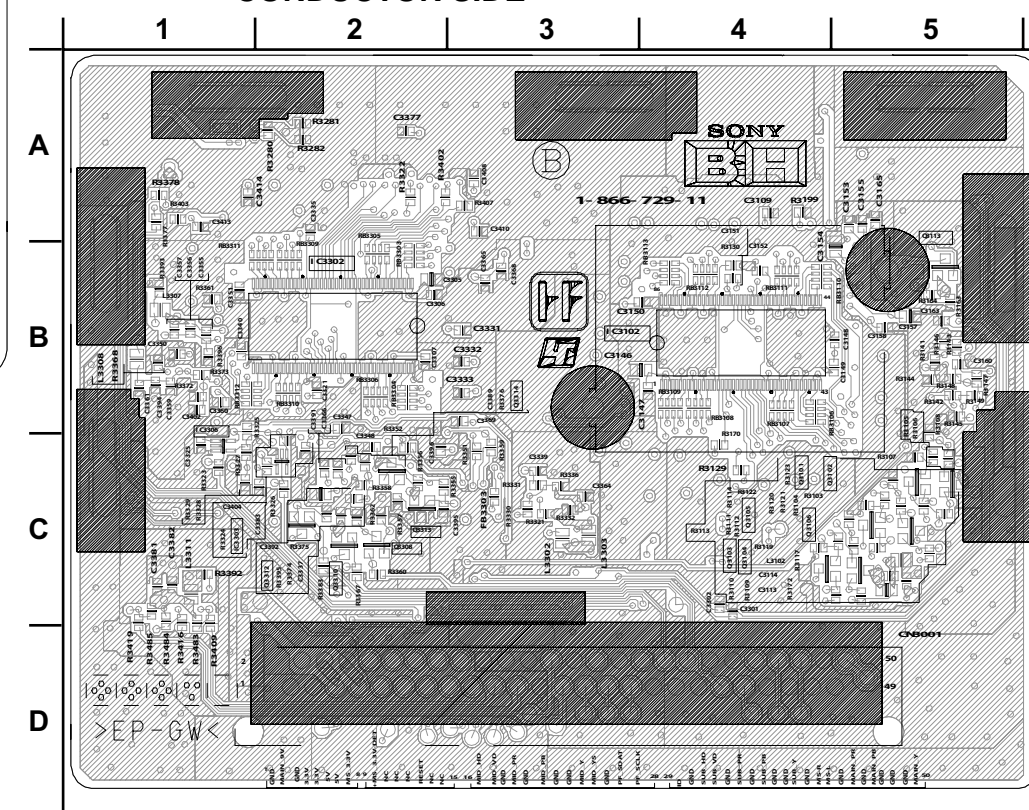

G BOARD SCHEMATIC DIAGRAM

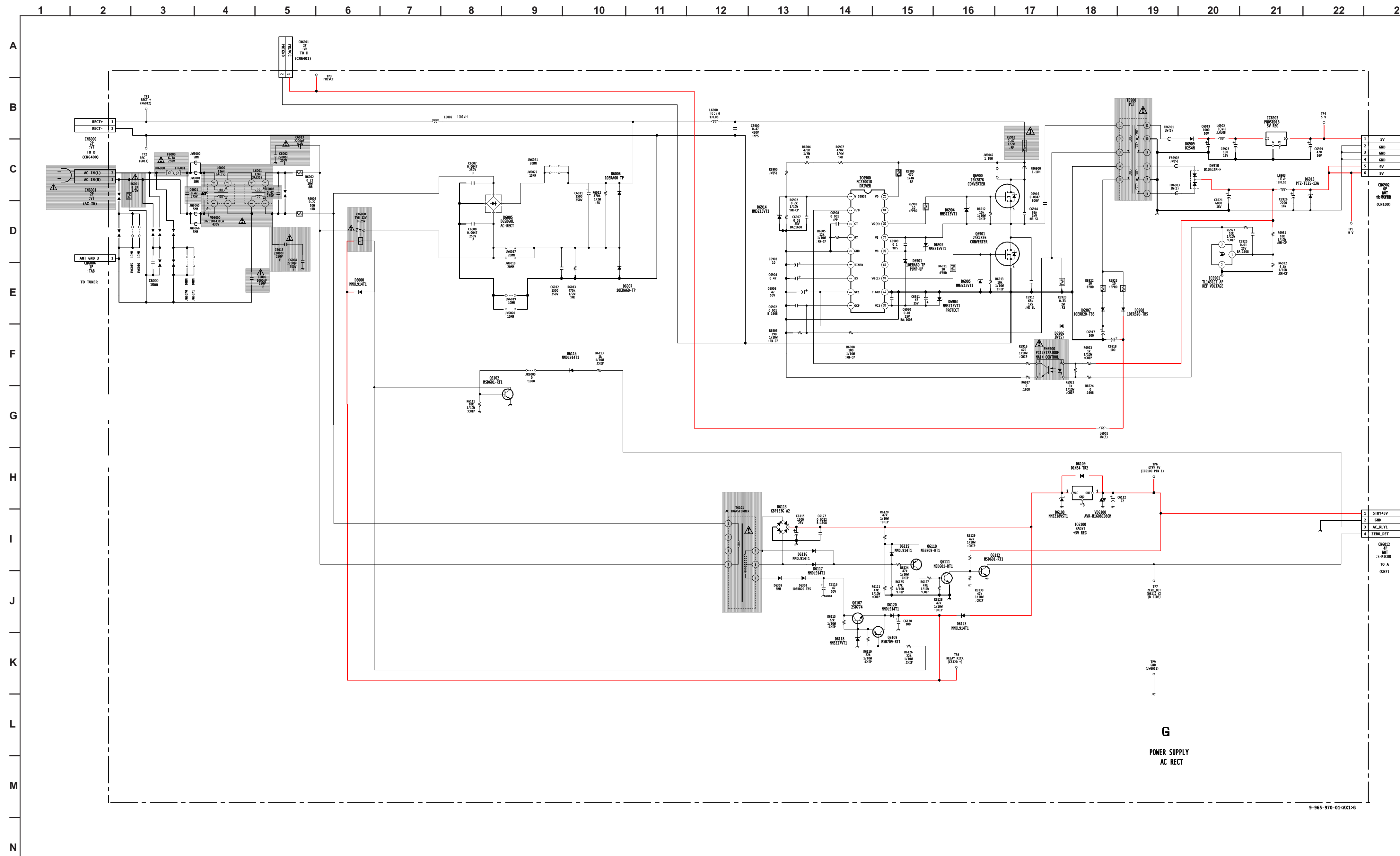

G BOARD IC VOLTAGE LIST

IC6100		IC6901	
PIN	VOLT	PIN	VOLT
1	7.0	1	2.4
0	5.0	2	GND
G	GND	3	6.1
IC6900		IC6902	
PIN	VOLT	PIN	VOLT
1	2.8	1	6.7
2	1.8	0	5
3	2.2	G	GND
4	2.5		
5	GND		
6	0.0		
7	4.6		
8	17.9		
9	0.0		
10	10.5		
11	GND		
12	4.8		
13	N/C		
14	151.8		
15	142.2		
16	146.3		
17	N/C		
18	342.0		

All voltages are in V.

G BOARD TRANSISTOR VOLTAGE LIST

	B	C	E
Q6102	0.8	0.0	GND
Q6107	8.4	41.5	8.4
Q6109	7.7	8.3	8.3
Q6110	6.4	0.7	6.2
Q6111	0.5	0.8	GND
Q6112	0.8	0.5	GND

All voltages are in V.

G
POWER SUPPLY
AC RECT

9-965-970-01-AR1-G

G [POWER SUPPLY, AC RECT]
COMPONENT SIDE

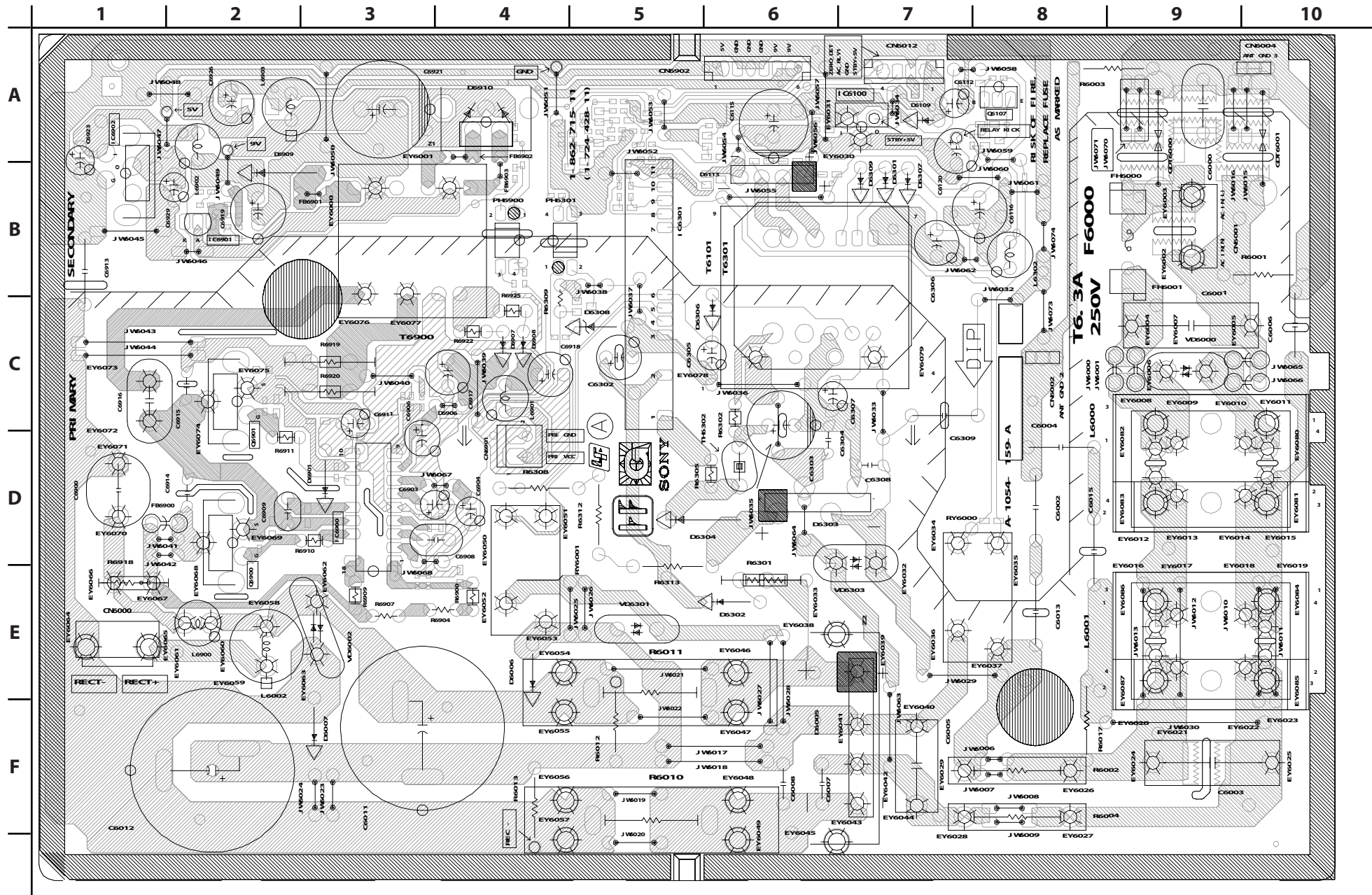

G [POWER SUPPLY, AC RECT]
CONDUCTOR SIDE

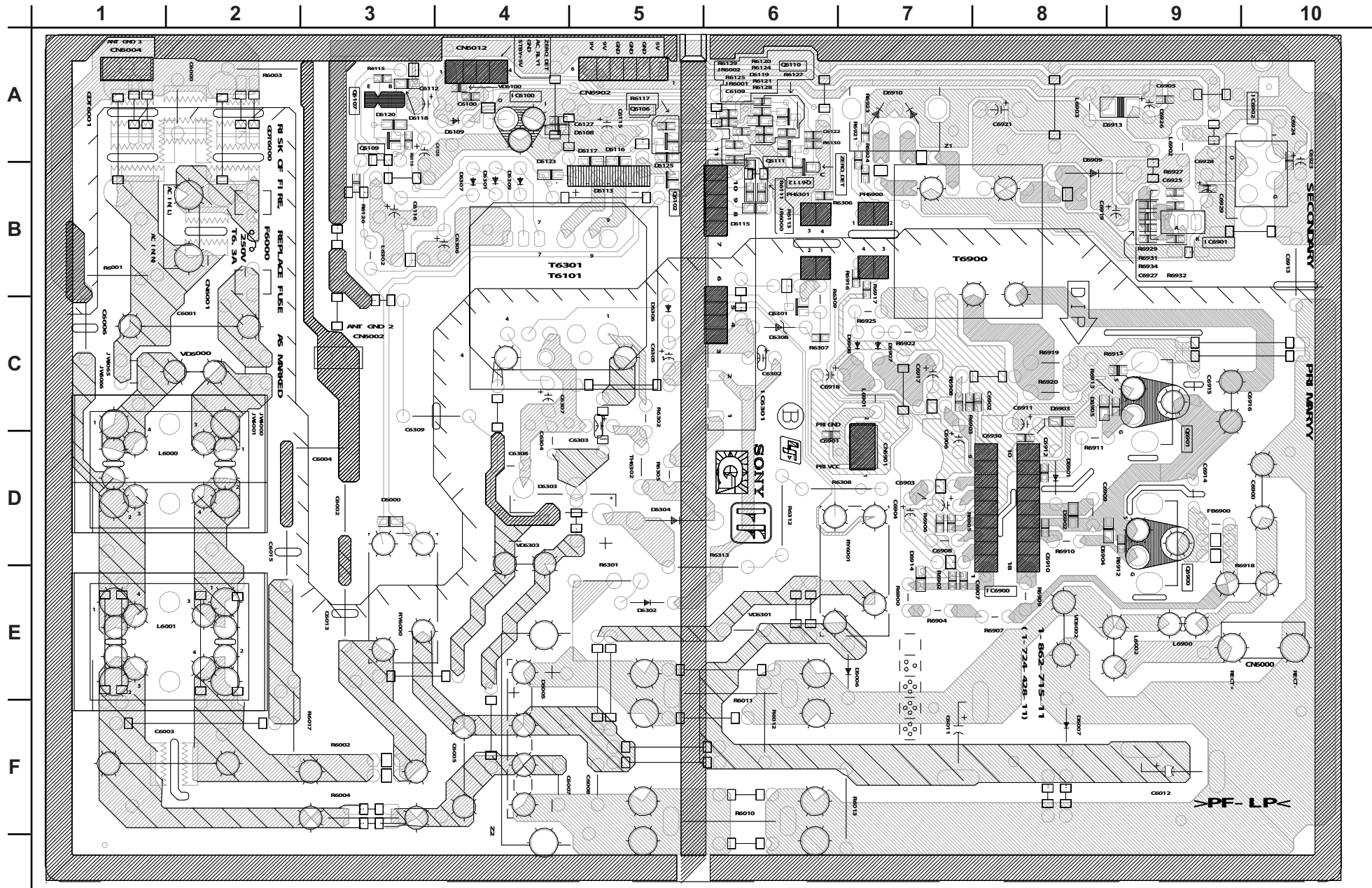

HA2 BOARD SCHEMATIC DIAGRAM

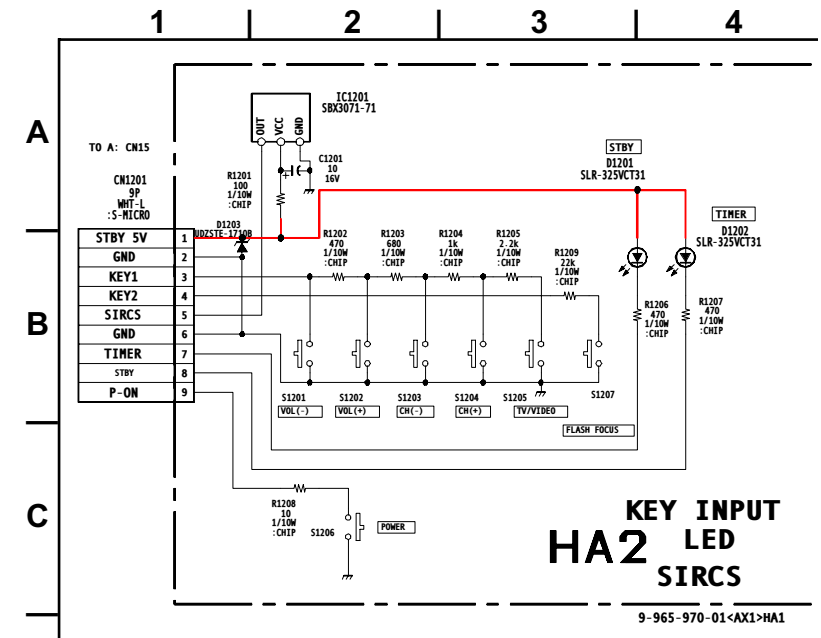

HA2 [KEY INPUT, LED, SIRCS]
COMPONENT SIDE

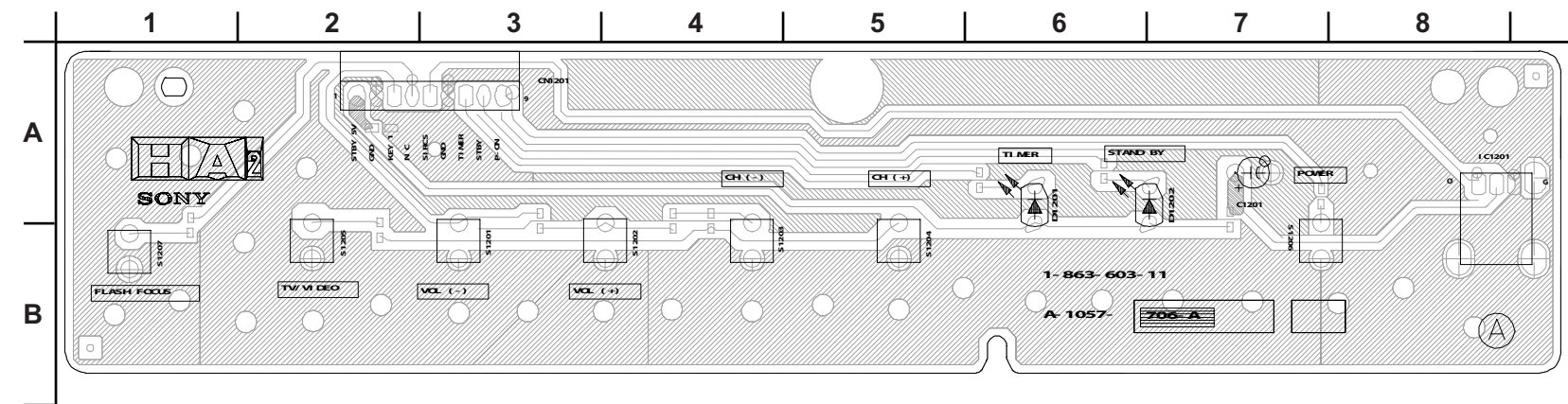

HA2 [KEY INPUT, LED, SIRCS]
CONDUCTOR SIDE

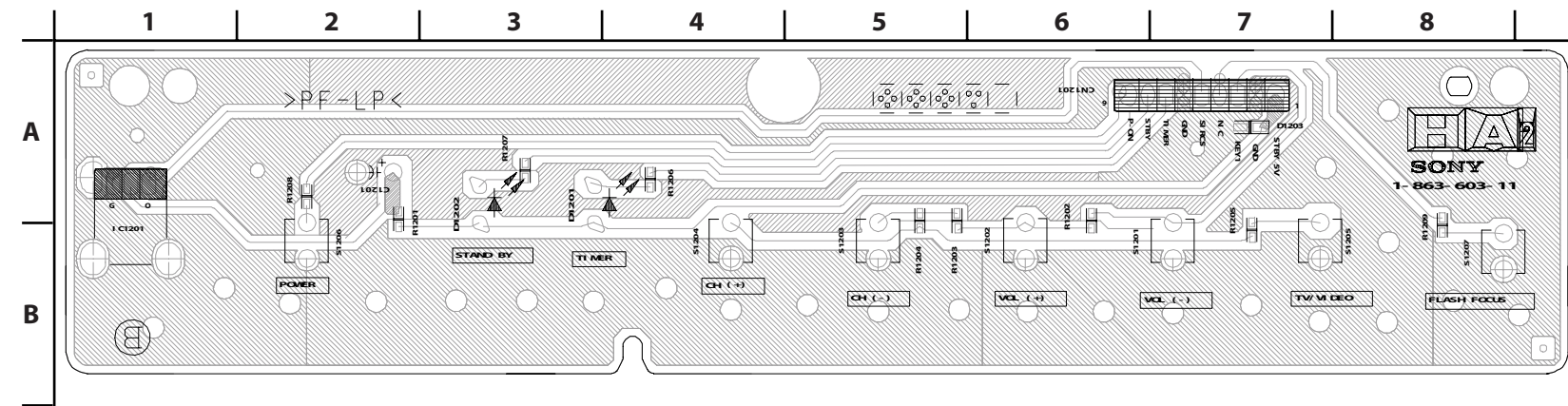

P BOARD SCHEMATIC DIAGRAM

Due to the complexity of this board, performing component level field repairs is not recommended. If service is required, complete board replacement is the preferred repair method. Data is provided for reference only.

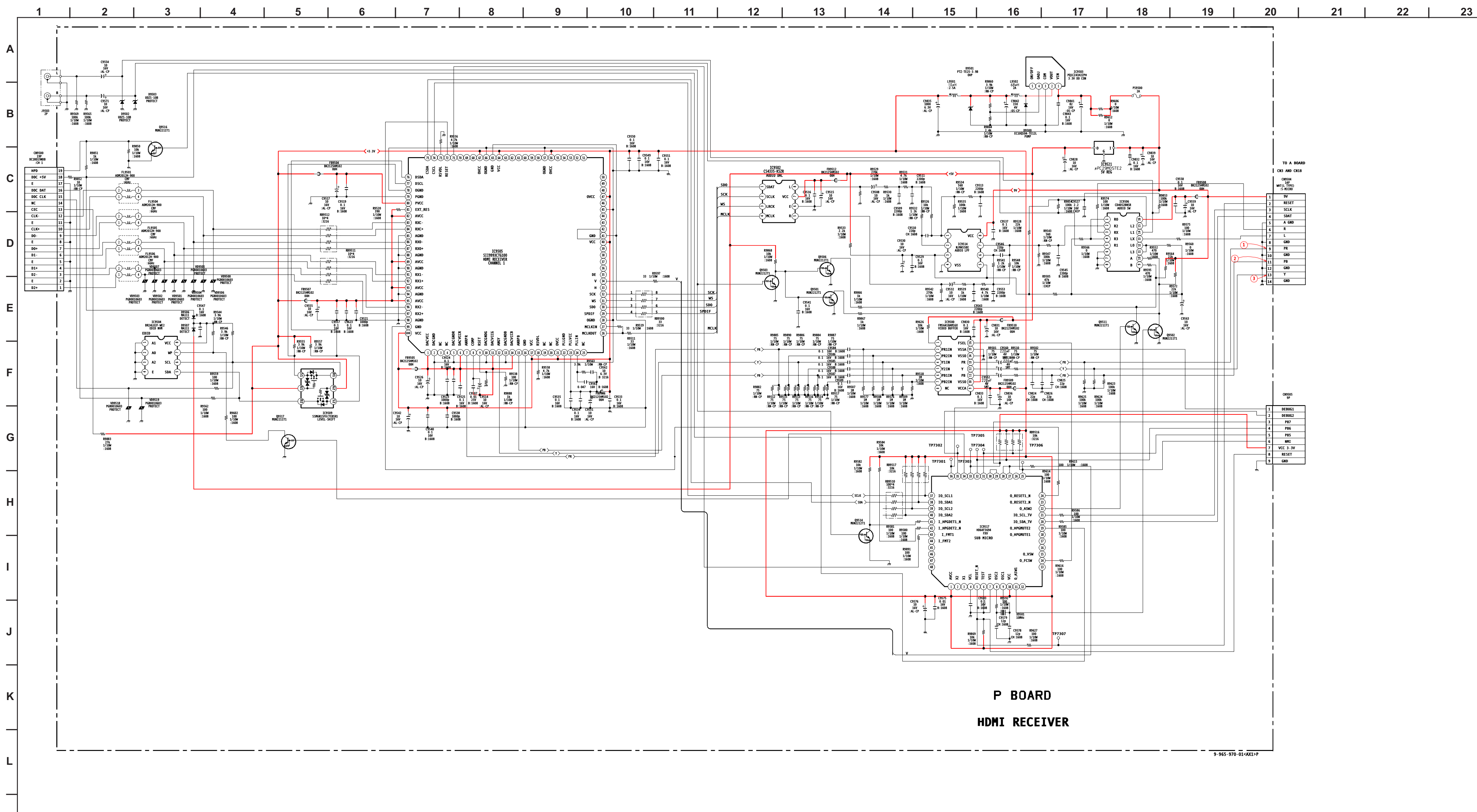

P BOARD WAVEFORMS

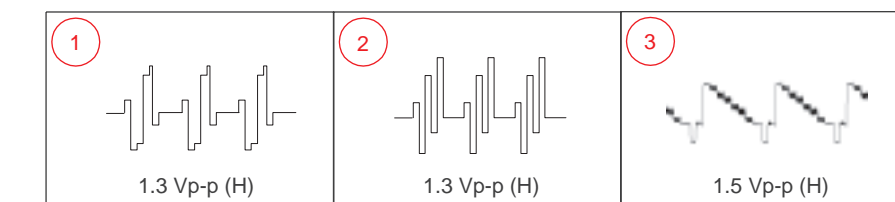

[HDMI RECEIVER] COMPONENT SIDE

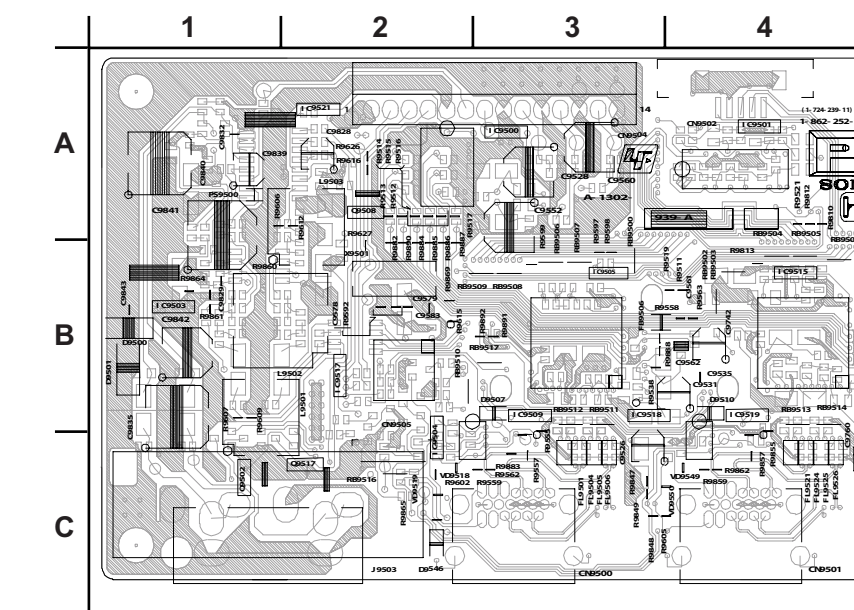

[HDMI RECEIVER] CONDUCTOR SIDE

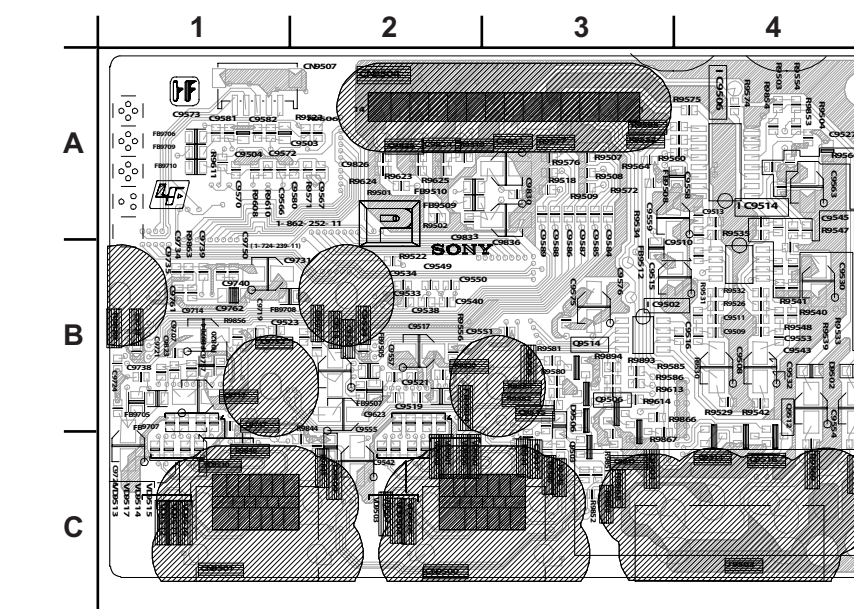

SR BOARD SCHEMATIC DIAGRAM

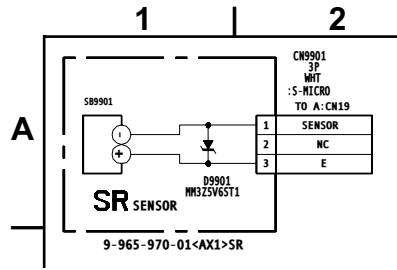

Due to the complexity of this board, performing component level field repairs is not recommended. If service is required, complete board replacement is the preferred repair method. Data is provided for reference only.

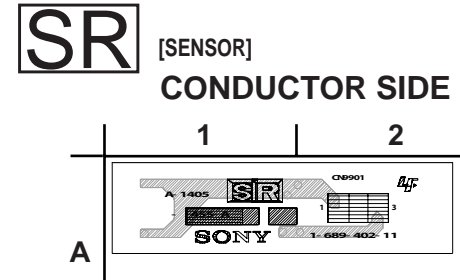
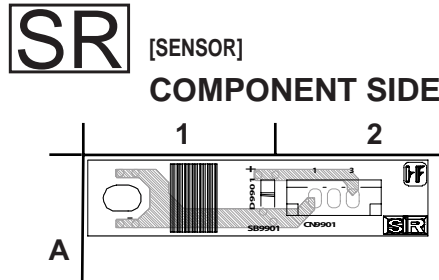

HB3 BOARD SCHEMATIC DIAGRAM

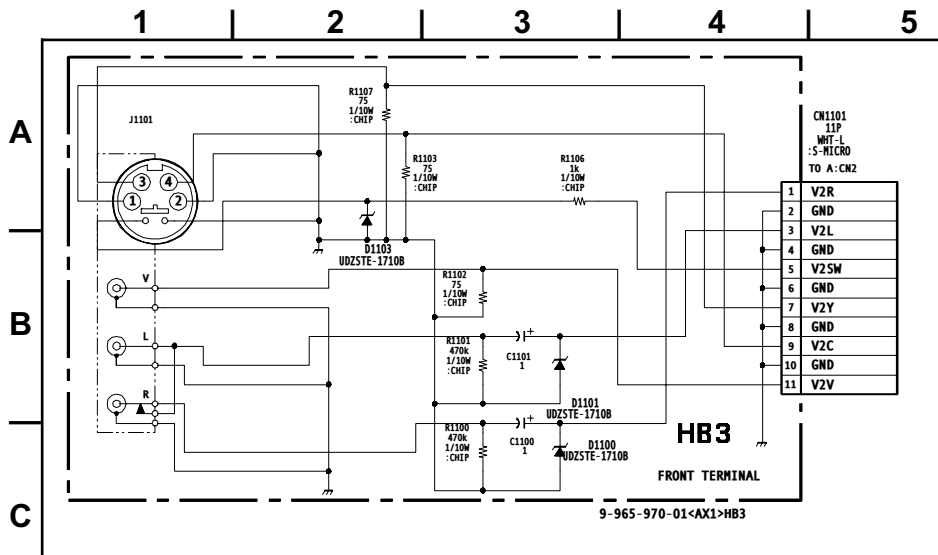

HB3 [FRONT TERMINAL]
COMPONENT SIDE

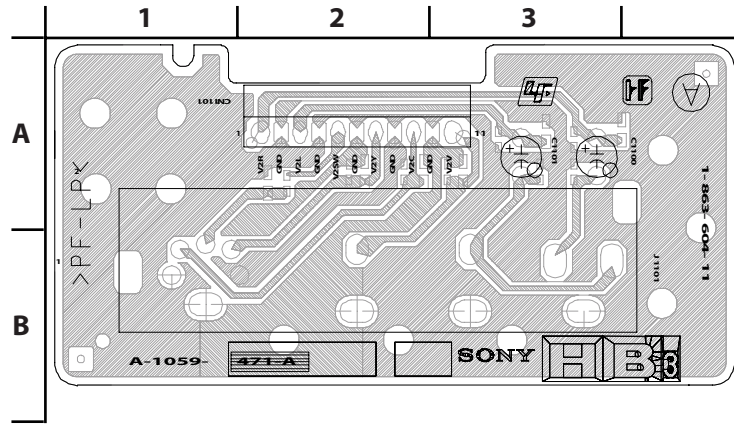

HB3 [FRONT TERMINAL]
CONDUCTOR SIDE

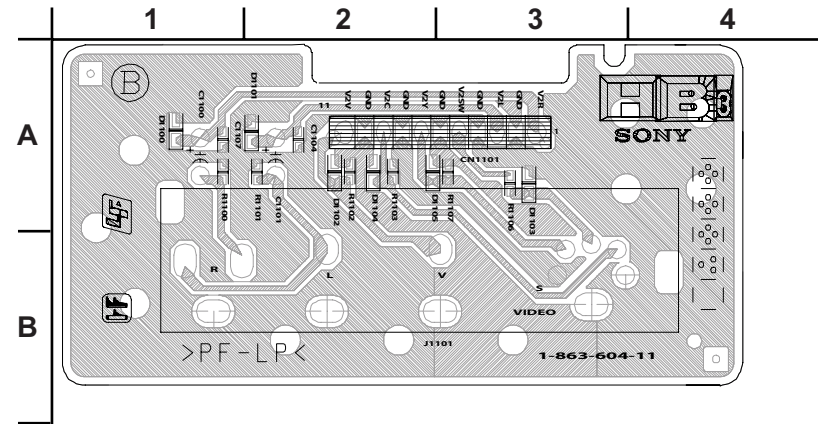

SECTION 6: EXPLODED VIEWS

Components not identified by a part number or description are not stocked because they are seldom required for routine service.

The component parts of an assembly are indicated by the reference numbers in the far right column of the parts list and within the dotted lines of the diagram.

* Items marked with an asterisk are not stocked since they are seldom required for routine service. Expect some delay when ordering these components.

NOTE: The components identified by shading and  mark are critical for safety. Replace only with part number specified.

NOTE: Les composants identifiés par un trame et une marque  sont critiques pour la sécurité. Ne les remplacer que par une pièce portant le numéro spécifique.

6-1. COVER

■ 7-685-661-14 SCREW +BVTP 4X12 TYPE2 IT-3

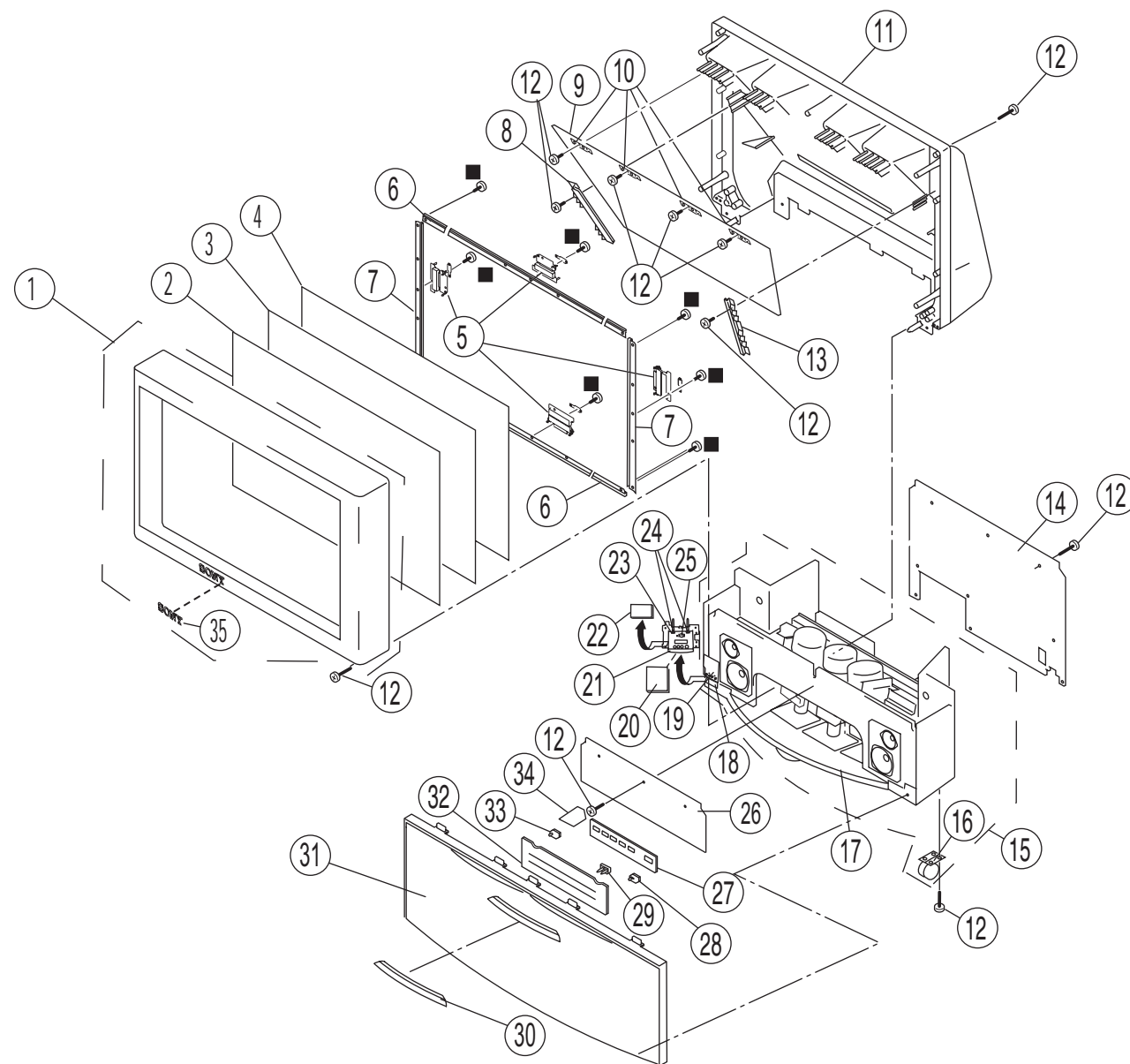

REF.NO.	PART NO.	DESCRIPTION	ASSEMBLY INCLUDES	REF.NO.	PART NO.	DESCRIPTION	ASSEMBLY INCLUDES
1	X-2021-371-2	BEZEL (51) ASSY (KDP-51WS655 ONLY)	[35]	*	14	2-023-380-01	BOARD(51), REAR (KDP-51WS655 ONLY)
1	X-2021-566-1	BEZNET (57) ASSY (KDP-57WS655 ONLY)		*	14	2-022-468-01	BOARD (57), REAR (KDP-57WS655 ONLY)
2	2-059-424-31	SCREEN (51), CONTRAST (KDP-51WS655 ONLY)		15	X-2024-193-3	CABINET(51)ASSY, BOTTOM	[16] (KDP-51WS655 ONLY)
2	2-059-427-11	SCREEN (57), CONTRAST (KDP-57WS655 ONLY)		15	X-2024-192-4	CABINET (57), ASSY, BOTTOM	[16] (KDP-57WS655 ONLY)
3	2-059-423-31	PLATE (51WL), DIFFUSION (KDP-51WS655 ONLY)		16	4-040-755-01	CASTER (DIA. 30)	(KDP-51WS655 ONLY)
3	2-059-426-11	PLATE (57WL), DIFFUSION (KDP-57WS655 ONLY)		16	4-040-755-21	CASTER (DIA. 30)	(KDP-57WS655 ONLY)
4	2-059-422-31	PLATE (51WFV), DIFFUSION (KDP-51WS655 ONLY)		17	2-023-069-01	SKIRT (51), FRONT (KDP-51WS655 ONLY)	
4	2-059-425-11	PLATE (57WF), DIFFUSION (KDP-57WS655 ONLY)		17	2-022-470-01	SKIRT (57), FRONT (KDP-57WS655 ONLY)	
*	5	A-1405-083-A	SR BOARD, MOUNTED	18	4-088-572-02	LABEL, INPUT TERMINAL	
*	6	4-084-617-02	HOLDER, SCREEN (KDP-51WS655 ONLY)	19	4-088-569-03	BRACKET, INPUT TERMINAL	
*	6	4-084-568-02	HOLDER, SCREEN (KDP-57WS655 ONLY)	20	4-088-571-02	PLATE, INPUT TERMINAL	
*	7	4-084-617-12	HOLDER, SCREEN (KDP-51WS655 ONLY)	21	3-973-975-41	DAMPER, OIL	
*	7	4-084-568-12	HOLDER, SCREEN (KDP-57WS655 ONLY)	*	22	A-1059-471-A	HB3 BOARD, MOUNTED
*	8	2-023-093-01	HOLDER (L), MIRROR SIDE (KDP-51WS655 ONLY)	23	4-088-570-01	COVER, INPUT TERMINAL	
*	8	4-083-462-01	HOLDER (L), MIRROR SIDE (KDP-57WS655 ONLY)	24	4-088-573-01	SPRING	
*	9	2-023-094-01	MIRROR (51) (KDP-51WS655 ONLY)	25	4-047-464-01	CATCHER, PUSH	
9	4-084-561-03	MIRROR (57) (KDP-57WS655 ONLY)		*	26	2-023-377-01	BOARD(51), FRONT (KDP-51WS655 ONLY)
*	10	4-081-501-01	HOLDER, MIRROR	*	26	2-022-471-01	BOARD (57), FRONT (KDP-57WS655 ONLY)
*	11	2-023-091-01	COVER (51), MIRROR (KDP-51WS655 ONLY)	*	27	A-1057-706-A	HA2 BOARD, MOUNTED
*	11	4-083-466-11	COVER (57), MIRROR (KDP-57WS655 ONLY)	28	2-102-899-01	GUIDE, LED	
12	4-081-063-11	SCREW, DOME WASHER HEX TAP 4X20		29	2-102-898-01	GUIDE, IR	
*	13	2-023-092-01	HOLDER (R), MIRROR SIDE (KDP-51WS655 ONLY)	30	2-023-098-11	PANEL (S), CONTROL (KDP-51WS655 ONLY)	
*	13	4-083-461-01	HOLDER (R), MIRROR SIDE (KDP-57WS655 ONLY)	30	2-023-097-11	PANEL (L), CONTROL (KDP-57WS655 ONLY)	
				31	X-2022-296-1	GRILLE (51) ASSY, SPEAKER (KDP-51WS655 ONLY)	
				31	X-2021-597-3	GRILLE (57) SPEAKER, ASSY (KDP-57WS655 ONLY)	
				32	2-103-258-01	BUTTON ASSY	
				33	2-102-900-01	GUIDE (QH), LED	
				*	34	A-1303-030-A	QH BOARD, COMPLETE
				35	3-704-179-01	EMBLEM (NO. 9), SONY (KDP-51WS655 ONLY)	

NOTE: The components identified by shading and \triangle mark are critical for safety. Replace only with part number specified.

NOTE: Les composants identifiés par un triangle et une marque \triangle sont critiques pour la sécurité. Ne les remplacer que par une pièce portant le numéro spécifié.

6-2. CHASSIS

- 7-685-648-79 SCREW +BVTP 3X12 TYPE2 IT-3
- 7-685-661-14 SCREW +BVTP 4X12 TYPE2 IT-3
- ★ 4-382-854-01 SCREW (M3X8), P, SW (+)
- 3-682-691-00 NUT, WASHER HEXAGON

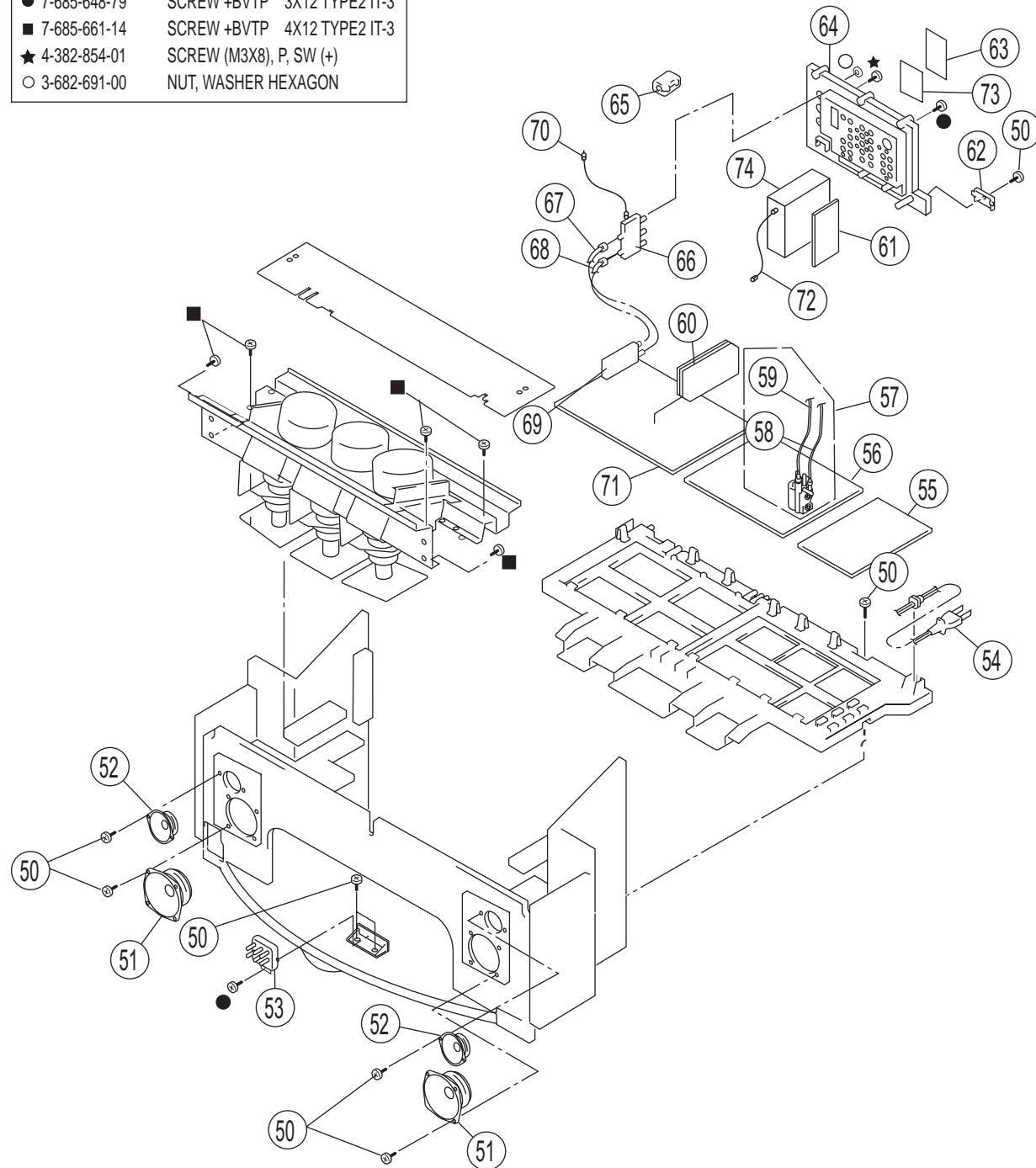

REF.NO.	PART NO.	DESCRIPTION	ASSEMBLY INCLUDES	REF.NO.	PART NO.	DESCRIPTION
50	4-081-063-01	SCREW, DOME WASHER HEX TAP 4X20		63	2-023-279-11	LABEL, TERMINAL
51	1-825-525-11	LOUDSPEAKER (13CM)		64	2-023-282-21	BOARD, TERMINAL
52	1-529-403-41	LOUDSPEAKER (6.6CM)		65	1-500-497-11	FILTER, CLAMP (FERRITE CORE)
\triangle 53	1-223-925-34	RESISTOR ASSY (HIGH-VOLTAGE)		\triangle 66	8-597-906-00	ANTENNA SWITCH RFD-SA801
\triangle 54	1-769-837-13	CORD, POWER (WITH NOISE FILTER)		* 67	1-556-945-21	CABLE, P-P
* 55	A-1065-549-A	G BOARD, COMPLETE		* 68	1-557-056-31	CABLE, P-P
* \triangle 56	A-1065-548-A	D BOARD, COMPLETE		\triangle 69	8-598-594-10	TUNER, FSS BTF-FA421
The high-voltage leads associated with the FBT on the D board are not included and must be ordered separately. (See 58-60)				70	1-829-702-11	COAXIAL CABLE WITH F-PLUG
\triangle 57	1-453-450-11	FBT ASSY NX-6030/M3A4	[58-59]	* 71	A-1065-547-A	A BOARD, COMPLETE
\triangle 58	1-779-095-51	LEAD ASSY, HIGH-VOLTAGE		72	1-827-516-11	USB CABLE
\triangle 59	1-900-260-40	CONNECTOR ASSY, MV		* 73	1-417-507-11	POD-HOST CERT, D-CABLE READY
* 60	A-1071-980-A	BH BOARD, COMPLETE		74	A-1084-090-A	Q BOX ASSY
* 60	A-1111-561-A	BH BOARD, COMPLETE		The Q Box Assembly contains the QT, QM and QU Boards. These boards cannot be ordered separately.		
The BH Boards are manufactured at different facilities. Either board can be used as a replacement.						
* 61	A-1068-754-A	P BOARD, COMPLETE				
62	4-069-675-01	CAP, TERMINAL BOARD				

NOTE: The components identified by shading and \triangle mark are critical for safety. Replace only with part number specified.

NOTE: Les composants identifiés par un trame et une marque \triangle sont critiques pour la sécurité. Ne les remplacer que par une pièce portant le numéro spécifié.

6-3. PICTURE TUBE

- 7-685-648-79 SCREW +BVTP 3X12 TYPE2 IT-3
- 7-685-661-14 SCREW +BVTP 4X12 TYPE2 IT-3

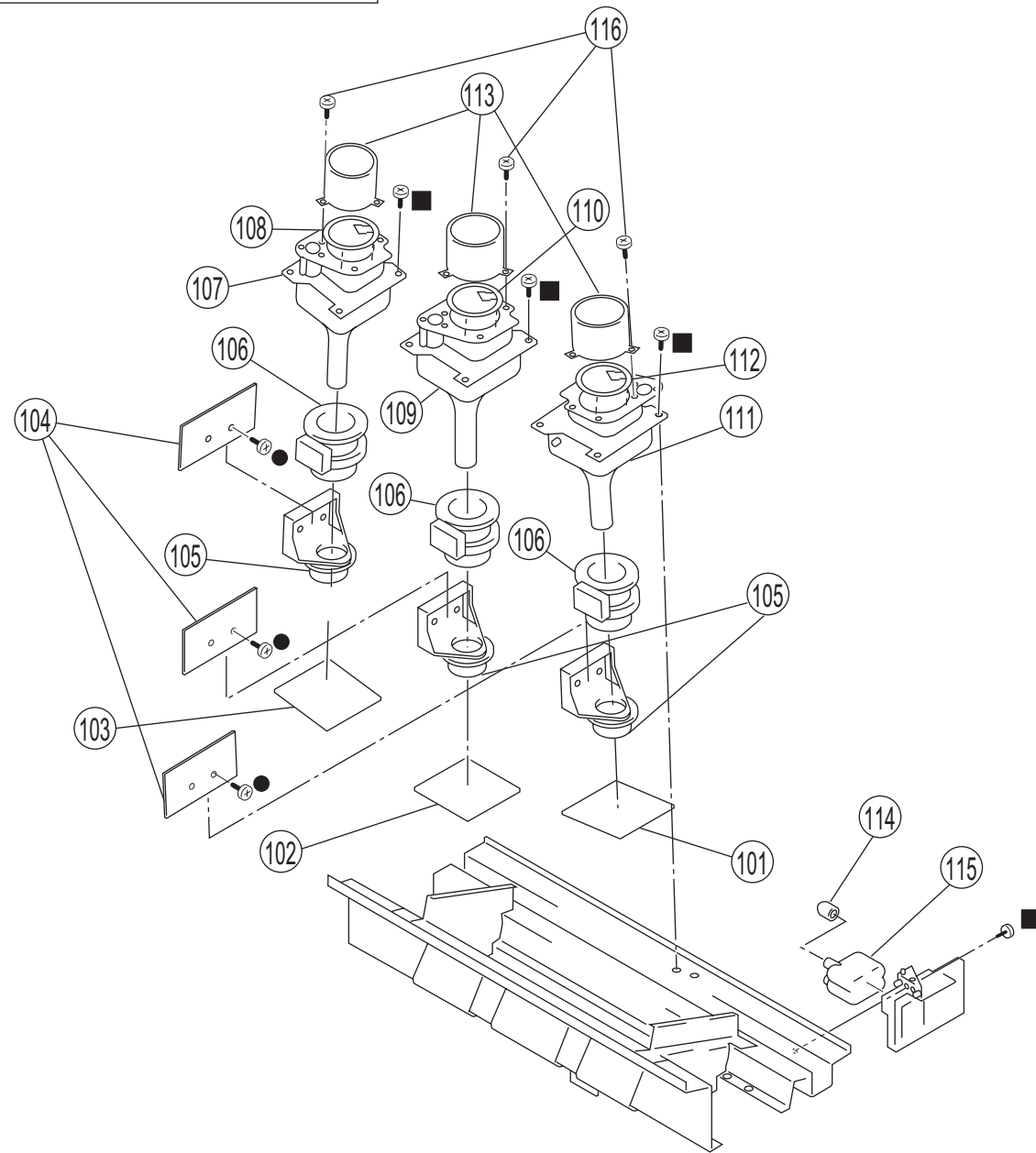

REF.NO.	PART NO.	DESCRIPTION	REF.NO.	PART NO.	DESCRIPTION
* 101	A-1054-147-A	CB BOARD, MOUNTED	110	4-096-119-02	SHADE (51-G) (KDP-51WS655 SERIAL # 8,500,001 AND UP ONLY)
* 102	A-1054-148-A	CG BOARD, MOUNTED	110	4-101-291-02	SHADE (G) (KDP-57WS655 ONLY)
* 103	A-1054-146-A	CR BOARD, MOUNTED			
* 104	A-1405-662-A	VM BOARD, MOUNTED			
\triangle 105	1-452-790-33	NECK ASSEMBLY (KDP-51WS655 ONLY)	\triangle 111	8-735-185-05	CRT 07MRC31(B) 16LWP13BMB (KDP-51WS655 ONLY)
\triangle 105	1-451-535-14	COIL ASSY, VM (KDP-57WS655 ONLY)	● \triangle 111	A-1107-616-A	COUPLER (B) ASSY, CRT (KDP-51WS655 SERIAL # 8,500,001 AND UP ONLY)
\triangle 106	1-451-537-41	DEFLECTION YOKE (KDP-51WS655 ONLY)	\triangle 111	A-1073-027-A	COUPLER (B) ASSY, CRT (KDP-57WS655 ONLY)
\triangle 106	1-451-537-31	DEFLECTION YOKE (KDP-57WS655 ONLY)			SNs 9700001 - 9702146 (Delta 265 System) SNs 9702445 - 9713503 (Delta 265 System)
\triangle 107	8-735-186-05	CRT 07MRC31(R) 16LWP13RFA (KDP-51WS655 ONLY)	● \triangle 111	A-1604-493-A	COUPLER (B) ASSY, CRT (KDP-57WS655 ONLY)
● \triangle 107	A-1107-617-A	COUPLER (R) ASSY, CRT (KDP-51WS655 SERIAL # 8,500,001 AND UP ONLY)			SNs 9702147 - 9702444 (Delta 260 System) SNs 9713504 and up (Delta 260 System)
● \triangle 107	A-1073-025-A	COUPLER (R) ASSY, CRT (KDP-57WS655 ONLY)	112	4-101-511-01	SHADE BLUE (KDP-51WS655 ONLY)
● \triangle 107	A-1604-491-A	COUPLER (R) ASSY, CRT (KDP-57WS655 ONLY)	112	2-590-896-01	SHADE (B) (KDP-51WS655 SERIAL # 8,500,001 AND UP ONLY)
● \triangle 108	4-096-118-02	SHADE (51-R) (KDP-51WS655 SERIAL # 8,500,001 AND UP ONLY)	112	4-101-761-02	SHADE (B) (FOR DELTA 265) (KDP-57WS655 ONLY)
108	4-088-542-02	SHADE (R) (KDP-57WS655 ONLY)	112	4-101-444-02	SHADE (B) (FOR DELTA 260) (KDP-57WS655 ONLY)
\triangle 109	8-735-182-05	CRT 07MRC21(G) 16LWP12HAA (KDP-51WS655 ONLY)	113	4-083-751-01	LENS (DELTA 250) (KDP-51WS655 ONLY)
● \triangle 109	A-1107-615-A	COUPLER (G) ASSY, CRT (KDP-51WS655 SERIAL # 8,500,001 AND UP ONLY)	113	4-087-841-01	LENS (DELTA 265) (KDP-57WS655 ONLY)
● \triangle 109	A-1073-026-A	COUPLER (G) ASSY, CRT (KDP-57WS655 ONLY)	113	4-083-750-01	LENS (DELTA 260) (KDP-57WS655 ONLY)
● \triangle 109	A-1604-483-A	COUPLER (G) ASSY, CRT (KDP-57WS655 ONLY)	114	4-373-137-01	CAP (Z), RUBBER
		SNs 9700001 - 9702146 (Delta 265 System) SNs 9702445 - 9713503 (Delta 265 System)	\triangle 115	8-598-875-00	BLOCK ASSY, HIGH-VOLTAGE
		SNs 9702147 - 9702444 (Delta 260 System) SNs 9713504 and up (Delta 260 System)	116	7-685-663-71	SCREW +BVTP 4X16 TYPE2 IT-3

SECTION 7: ELECTRICAL PARTS LIST

NOTE: The components identified by shading and \triangle mark are critical for safety. Replace only with part number specified.

NOTE: Les composants identifiés par un trame et une marque \triangle sont critiques pour la sécurité. Ne les remplacer que par une pièce portant le numéro spécifique.

The components in this manual identified by the following symbol: \boxtimes indicate parts that have been carefully factory-selected to satisfy regulations regarding X-ray radiation for each set.

Should replacement be required for one of these components, replace only with the value originally used.

* Items marked with an asterisk are not stocked since they are seldom required for routine service. Expect some delay when ordering these components.

RESISTORS

- All resistors are in ohms
- F : nonflammable
- All variable and adjustable resistors have characteristic curve B, unless otherwise noted.

CR

When ordering parts by reference number, please include the board name.

REF. NO.	PART NO.	DESCRIPTION	VALUES	REF. NO.	PART NO.	DESCRIPTION	VALUES
CR				FERRITE BEAD			
*	A-1054-146-A	CR BOARD, MOUNTED		FB9101	1-469-578-11	FERRITE	1.1 μ H
	4-382-854-11	SCREW (M3X10), P, SW (+)		IC			
				IC9101	8-759-680-01	IC	TDA6120Q/N2/S1
CAPACITOR				JACK			
C9101	1-104-570-11	CERAMIC	0.001 μ F 10% 2KV	\triangle J9101	1-251-182-11	SOCKET, CRT	
C9102	1-162-919-11	CERAMIC CHIP	22pF 5% 50V	COIL			
C9103	1-164-156-11	CERAMIC CHIP	0.1 μ F 25V	L9101	1-414-856-11	INDUCTOR	10 μ H
C9105	1-107-962-11	ELECT	22 μ F 20% 250V	L9102	1-414-855-31	INDUCTOR	1 μ H
C9106	1-162-114-00	CERAMIC	4700pF 1KV	L9103	1-414-856-11	INDUCTOR	10 μ H
C9107	1-162-966-11	CERAMIC CHIP	0.0022 μ F 10% 50V	NEON LAMP			
C9108	1-126-935-11	ELECT	470 μ F 20% 16V	\triangle NL9102	1-517-778-21	LAMP, NEON	
C9110	1-164-156-11	CERAMIC CHIP	0.1 μ F 25V	NL9103	1-517-778-21	LAMP, NEON	
C9111	1-164-156-11	CERAMIC CHIP	0.1 μ F 25V	TRANSISTOR			
C9112	1-126-933-11	ELECT	100 μ F 20% 16V	Q9101	8-729-010-25	TRANSISTOR	MSD601-RT1
C9114	1-162-966-11	CERAMIC CHIP	0.0022 μ F 10% 50V	Q9102	8-729-028-28	TRANSISTOR	2SK2036(TE85L)
C9115	1-162-966-11	CERAMIC CHIP	0.0022 μ F 10% 50V	Q9103	8-729-010-05	TRANSISTOR	MSB709-RT1
C9117	1-164-156-11	CERAMIC CHIP	0.1 μ F 25V	Q9104	8-729-010-05	TRANSISTOR	MSB709-RT1
CONNECTOR				Q9105	8-729-122-63	TRANSISTOR	2SA1226-E4
*	CN9101	1-564-510-11	PLUG, CONNECTOR 7P	RESISTOR			
*	CN9102	1-564-507-11	PLUG, CONNECTOR 4P	R9101	1-260-133-11	CARBON	680K 5% 1/2W
*	CN9103	1-564-508-11	PLUG, CONNECTOR 5P	R9102	1-249-425-11	CARBON	4.7K 5% 1/4W
	CN9104	1-695-915-11	TAB (CONTACT)	R9103	1-216-809-11	METAL CHIP	100 5% 1/10W
	CN9107	1-785-879-11	CONNECTOR, ONE TOUCH	R9104	1-260-132-11	CARBON	560K 5% 1/2W
	CN9110	1-695-915-11	TAB (CONTACT)				
DIODE							
D9101	8-719-970-83	DIODE	HSS82-TJ				
D9104	8-719-970-83	DIODE	HSS82-TJ				
D9109	8-719-081-97	DIODE	MMDL914T1				

NOTE: The components identified by shading and \triangle mark are critical for safety. Replace only with part number specified.

NOTE: Les composants identifiés par un triangle et une marque \triangle sont critiques pour la sécurité. Ne les remplacer que par une pièce portant le numéro spécifique.

CR CB

REF. NO.	PART NO.	DESCRIPTION	VALUES			REF. NO.	PART NO.	DESCRIPTION	VALUES		
R9105	1-218-851-11	METAL CHIP	1.5K	0.50%	1/10W	C9309	1-164-156-11	CERAMIC CHIP	0.1 μ F		25V
R9106	1-218-835-11	METAL CHIP	330	0.50%	1/10W	C9310	1-164-156-11	CERAMIC CHIP	0.1 μ F		25V
R9107	1-216-825-11	METAL CHIP	2.2K	5%	1/10W	C9311	1-126-933-11	ELECT	100 μ F	20%	16V
R9108	1-218-871-11	METAL CHIP	10K	0.50%	1/10W	C9312	1-162-114-00	CERAMIC	4700pF		1KV
R9109	1-218-845-11	METAL CHIP	820	0.50%	1/10W	C9313	1-164-156-11	CERAMIC CHIP	0.1 μ F		25V
R9110	1-249-393-11	CARBON	10	5%	1/4W	C9314	1-162-970-11	CERAMIC CHIP	0.01 μ F	10%	25V
R9114	1-218-855-11	METAL CHIP	2.2K	0.50%	1/10W	C9315	1-162-966-11	CERAMIC CHIP	0.0022 μ F	10%	50V
R9115	1-218-863-11	METAL CHIP	4.7K	0.50%	1/10W	C9316	1-162-966-11	CERAMIC CHIP	0.0022 μ F	10%	50V
R9116	1-260-328-11	CARBON	1K	5%	1/2W	C9318	1-164-156-11	CERAMIC CHIP	0.1 μ F		25V
R9120	1-243-624-71	METAL OXIDE	33K	5%	3W	C9320	1-125-891-11	CERAMIC CHIP	0.47 μ F	10%	10V
R9122	1-260-320-11	CARBON	220	5%	1/2W						
R9126	1-218-903-11	METAL CHIP	220K	0.50%	1/10W			CONNECTOR			
R9127	1-218-903-11	METAL CHIP	220K	0.50%	1/10W						
R9129	1-216-827-11	METAL CHIP	3.3K	5%	1/10W	*	CN9301	1-564-511-11	PLUG, CONNECTOR		8P
R9131	1-216-823-11	METAL CHIP	1.5K	5%	1/10W	*	CN9302	1-564-510-11	PLUG, CONNECTOR		7P
R9132	1-216-833-11	METAL CHIP	10K	5%	1/10W	*	CN9303	1-564-507-11	PLUG, CONNECTOR		4P
R9133	1-216-809-11	METAL CHIP	100	5%	1/10W		CN9304	1-695-915-11	TAB (CONTACT)		
R9134	1-216-821-11	METAL CHIP	1K	5%	1/10W	*	CN9305	1-580-689-11	PIN, CONNECTOR (PC BOARD)		4P
R9135	1-260-087-11	CARBON	100	5%	1/2W		CN9308	1-785-879-11	CONNECTOR, ONE TOUCH		
R9136	1-218-855-11	METAL CHIP	2.2K	0.50%	1/10W	*	CN9309	1-564-507-11	PLUG, CONNECTOR		4P
R9137	1-218-855-11	METAL CHIP	2.2K	0.50%	1/10W		CN9310	1-695-915-11	TAB (CONTACT)		
R9147	1-216-864-11	SHORT CHIP									
		SPARK GAP									
SG9101	1-518-925-31	GAP, SPARK									
SG9102	1-519-422-11	GAP, SPARK									
SG9103	1-519-422-11	GAP, SPARK									
		CB									
*	A-1054-147-A	CB BOARD, MOUNTED									
	4-382-854-11	SCREW (M3X10), P, SW (+)									
		CAPACITOR									
C5550	1-162-964-11	CERAMIC CHIP	0.001 μ F	10%	50V						
C9301	1-104-570-11	CERAMIC	0.001 μ F	10%	2KV						
C9302	1-162-966-11	CERAMIC CHIP	0.0022 μ F	10%	50V						
C9303	1-107-662-11	ELECT	22 μ F	20%	350V						
C9304	1-162-920-11	CERAMIC CHIP	27pF	5%	50V						
C9305	1-162-916-11	CERAMIC CHIP	12pF	5%	50V						
C9306	1-164-156-11	CERAMIC CHIP	0.1 μ F		25V						
C9307	1-126-935-11	ELECT	470 μ F	20%	16V						
		DIODE									
D5520	8-719-072-66	DIODE									PDZ11B-115
D9301	8-719-081-97	DIODE									MMDL914T1
D9302	8-719-970-83	DIODE									HSS82-TJ
D9303	8-719-081-97	DIODE									MMDL914T1
D9305	6-500-029-01	DIODE									MM3Z12VST1
D9309	8-719-970-83	DIODE									HSS82-TJ
		FERRITE BEAD									
FB5206	1-469-578-11	FERRITE									1.1 μ H
FB9301	1-469-578-11	FERRITE									1.1 μ H
		IC									
IC9301	8-759-680-01	IC									TDA6120Q/N2/S1
		JACK									
\triangle	J9301	1-251-182-11	SOCKET, CRT								

NOTE: The components identified by shading and \triangle mark are critical for safety. Replace only with part number specified.

NOTE: Les composants identifiés par un trame et une marque \triangle sont critiques pour la sécurité. Ne les remplacer que par une pièce portant le numéro spécifique.



REF. NO.	PART NO.	DESCRIPTION	VALUES	REF. NO.	PART NO.	DESCRIPTION	VALUES
COIL				R9319	1-249-425-11	CARBON	4.7K 5% 1/4W
L9301	1-414-856-11	INDUCTOR	10 μ H	R9320	1-243-624-71	METAL OXIDE	33K 5% 3W
L9302	1-414-855-31	INDUCTOR	1 μ H	R9323	1-260-328-11	CARBON	1K 5% 1/2W
L9303	1-414-856-11	INDUCTOR	10 μ H	R9325	1-260-320-11	CARBON	220 5% 1/2W
NEON LAMP				R9327	1-218-901-11	METAL CHIP	180K 0.50% 1/10W
\triangle NL9302	1-517-778-21	LAMP, NEON		R9328	1-218-907-11	METAL CHIP	330K 0.50% 1/10W
NL9303	1-517-778-21	LAMP, NEON		R9330	1-216-827-11	METAL CHIP	3.3K 5% 1/10W
TRANSISTOR				R9332	1-216-823-11	METAL CHIP	1.5K 5% 1/10W
Q5520	6-550-659-01	TRANSISTOR	2SC4634LS-YB11	R9333	1-218-854-11	METAL CHIP	2K 0.50% 1/10W
Q5523	8-729-010-25	TRANSISTOR	MSD601-RT1	R9334	1-216-822-11	METAL CHIP	1.2K 5% 1/10W
Q9301	8-729-010-05	TRANSISTOR	MSB709-RT1	R9335	1-249-393-11	CARBON	10 5% 1/4W
Q9302	8-729-028-28	TRANSISTOR	2SK2036(TE85L)	R9339	1-260-087-11	CARBON	100 5% 1/2W
Q9304	8-729-010-25	TRANSISTOR	MSD601-RT1	R9340	1-218-871-11	METAL CHIP	10K 0.50% 1/10W
Q9305	8-729-010-05	TRANSISTOR	MSB709-RT1	R9342	1-216-834-11	METAL CHIP	12K 5% 1/10W
Q9306	8-729-010-05	TRANSISTOR	MSB709-RT1	R9343	1-216-832-11	METAL CHIP	8.2K 5% 1/10W
Q9307	8-729-010-05	TRANSISTOR	MSB709-RT1	R9344	1-216-845-11	METAL CHIP	100K 5% 1/10W
Q9309	8-729-122-63	TRANSISTOR	2SA1226-E4	R9345	1-218-863-11	METAL CHIP	4.7K 0.50% 1/10W
Q9311	8-729-010-25	TRANSISTOR	MSD601-RT1	R9346	1-216-833-11	METAL CHIP	10K 5% 1/10W
RESISTOR				R9347	1-216-821-11	METAL CHIP	1K 5% 1/10W
R5574	1-216-833-11	METAL CHIP	10K 5% 1/10W	R9348	1-216-821-11	METAL CHIP	1K 5% 1/10W
R5575	1-260-131-11	CARBON	470K 5% 1/2W	R9349	1-216-809-11	METAL CHIP	100 5% 1/10W
R5576	1-216-833-11	METAL CHIP	10K 5% 1/10W	R9350	1-218-855-11	METAL CHIP	2.2K 0.50% 1/10W
R5577	1-216-833-11	METAL CHIP	10K 5% 1/10W	R9351	1-218-855-11	METAL CHIP	2.2K 0.50% 1/10W
R5578	1-216-825-11	METAL CHIP	2.2K 5% 1/10W	R9352	1-216-864-11	SHORT CHIP	
R5580	1-216-833-11	METAL CHIP	10K 5% 1/10W	R9355	1-216-809-11	METAL CHIP	100 5% 1/10W
R9301	1-216-809-11	METAL CHIP	100 5% 1/10W	R9356	1-216-809-11	METAL CHIP	100 5% 1/10W
R9302	1-216-864-11	SHORT CHIP		SPARK GAP			
R9303	1-260-133-11	CARBON	680K 5% 1/2W	SG9301	1-518-925-31	GAP, SPARK	
R9304	1-260-132-11	CARBON	560K 5% 1/2W	SG9302	1-519-422-11	GAP, SPARK	
R9306	1-218-831-11	METAL CHIP	220 0.50% 1/10W	SG9303	1-519-422-11	GAP, SPARK	
R9307	1-218-851-11	METAL CHIP	1.5K 0.50% 1/10W	CG			
R9308	1-218-839-11	METAL CHIP	470 0.50% 1/10W	* A-1054-148-A CG BOARD, MOUNTED			
R9309	1-218-849-11	METAL CHIP	1.2K 0.50% 1/10W	4-382-854-11 SCREW (M3X10), P, SW (+)			
R9313	1-218-877-11	METAL CHIP	18K 0.50% 1/10W	CAPACITOR			
R9314	1-218-862-11	METAL CHIP	4.3K 0.50% 1/10W	C9201	1-107-662-11	ELECT	22 μ F 20% 350V
R9315	1-218-859-11	METAL CHIP	3.3K 0.50% 1/10W	C9202	1-104-570-11	CERAMIC	0.001 μ F 10% 2KV
R9316	1-218-853-11	METAL CHIP	1.8K 0.50% 1/10W	C9203	1-164-156-11	CERAMIC CHIP	0.1 μ F 25V
R9317	1-218-863-11	METAL CHIP	4.7K 0.50% 1/10W	C9204	1-126-935-11	ELECT	470 μ F 20% 16V
R9318	1-216-825-11	METAL CHIP	2.2K 5% 1/10W	C9205	1-164-378-11	CERAMIC CHIP	30pF 5% 50V



NOTE: The components identified by shading and \triangle mark are critical for safety. Replace only with part number specified.

NOTE: Les composants identifiés par un triangle et une marque \triangle sont critiques pour la sécurité. Ne les remplacer que par une pièce portant le numéro spécifique.

REF. NO.	PART NO.	DESCRIPTION	VALUES	REF. NO.	PART NO.	DESCRIPTION	VALUES
C9207	1-164-156-11	CERAMIC CHIP	0.1 μ F 25V	NEON LAMP			
C9208	1-164-156-11	CERAMIC CHIP	0.1 μ F 25V	\triangle NL9202	1-517-778-21	LAMP, NEON	
C9209	1-162-966-11	CERAMIC CHIP	0.0022 μ F 10% 50V	NL9203	1-517-778-21	LAMP, NEON	
C9211	1-126-933-11	ELECT	100 μ F 20% 16V	TRANSISTOR			
C9213	1-162-114-00	CERAMIC	4700pF 1KV	Q9201	8-729-010-25	TRANSISTOR	MSD601-RT1
C9214	1-162-966-11	CERAMIC CHIP	0.0022 μ F 10% 50V	Q9202	8-729-028-28	TRANSISTOR	2SK2036(TE85L)
C9216	1-162-966-11	CERAMIC CHIP	0.0022 μ F 10% 50V	Q9203	8-729-010-05	TRANSISTOR	MSB709-RT1
C9217	1-164-156-11	CERAMIC CHIP	0.1 μ F 25V	Q9204	8-729-122-63	TRANSISTOR	2SA1226-E4
CONNECTOR				RESISTOR			
*	CN9201	1-564-510-11	PLUG, CONNECTOR 7P	R9201	1-260-133-11	CARBON	680K 5% 1/2W
*	CN9202	1-564-510-11	PLUG, CONNECTOR 7P	R9202	1-260-132-11	CARBON	560K 5% 1/2W
*	CN9203	1-564-507-11	PLUG, CONNECTOR 4P	R9203	1-249-425-11	CARBON	4.7K 5% 1/4W
*	CN9204	1-564-507-11	PLUG, CONNECTOR 4P	R9204	1-216-809-11	METAL CHIP	100 5% 1/10W
*	CN9205	1-564-506-11	PLUG, CONNECTOR 3P	R9205	1-218-871-11	METAL CHIP	10K 0.50% 1/10W
CN9208	1-695-915-11	TAB (CONTACT)		R9206	1-218-832-11	METAL CHIP	240 0.50% 1/10W
CN9209	1-785-879-11	CONNECTOR, ONE TOUCH		R9207	1-218-849-11	METAL CHIP	1.2K 0.50% 1/10W
CN9210	1-695-915-11	TAB (CONTACT)		R9208	1-216-825-11	METAL CHIP	2.2K 5% 1/10W
DIODE				R9209	1-218-845-11	METAL CHIP	820 0.50% 1/10W
D9201	8-719-970-83	DIODE	HSS82-TJ	R9211	1-249-393-11	CARBON	10 5% 1/4W
D9206	8-719-970-83	DIODE	HSS82-TJ	R9216	1-218-854-11	METAL CHIP	2K 0.50% 1/10W
D9209	8-719-081-97	DIODE	MMDL914T1	R9217	1-218-863-11	METAL CHIP	4.7K 0.50% 1/10W
FERRITE BEAD				R9220	1-243-624-71	METAL OXIDE	33K 5% 3W
FB9201	1-469-578-11	FERRITE	1.1 μ H	R9221	1-260-328-11	CARBON	1K 5% 1/2W
IC				R9223	1-260-320-11	CARBON	220 5% 1/2W
IC9201	8-759-680-01	IC	TDA6120Q/N2/S1	R9225	1-218-899-11	METAL CHIP	150K 0.50% 1/16W
JACK				R9226	1-218-899-11	METAL CHIP	150K 0.50% 1/16W
\triangle J9201	1-251-182-11	SOCKET, CRT		R9228	1-216-827-11	METAL CHIP	3.3K 5% 1/10W
COIL				R9230	1-216-823-11	METAL CHIP	1.5K 5% 1/10W
L9201	1-414-856-11	INDUCTOR	10 μ H	R9231	1-260-087-11	CARBON	100 5% 1/2W
L9202	1-414-855-31	INDUCTOR	1 μ H	R9232	1-218-855-11	METAL CHIP	2.2K 0.50% 1/10W
L9203	1-414-856-11	INDUCTOR	10 μ H	R9233	1-218-855-11	METAL CHIP	2.2K 0.50% 1/10W
				SPARK GAP			
				SG9201	1-518-925-31	GAP, SPARK	
				SG9202	1-519-422-11	GAP, SPARK	
				SG9203	1-519-422-11	GAP, SPARK	



REF. NO.	PART NO.	DESCRIPTION	VALUES	REF. NO.	PART NO.	DESCRIPTION	VALUES
				Q9006	8-729-424-02	TRANSISTOR	2SB709A-QRS-TX
* A-1405-662-A VM BOARD, MOUNTED 4-382-854-11 SCREW (M3X10), P, SW (+)				Q9007	8-729-422-27	TRANSISTOR	2SD601A-Q
CAPACITOR				Q9008	8-729-424-02	TRANSISTOR	2SB709A-QRS-TX
C9001	1-126-933-11	ELECT	100µF 20% 16V	Q9009	8-729-422-27	TRANSISTOR	2SD601A-Q
C9002	1-164-156-11	CERAMIC CHIP	0.1µF 25V	Q9010	8-729-424-02	TRANSISTOR	2SB709A-QRS-TX
C9003	1-162-964-11	CERAMIC CHIP	0.001µF 10% 50V	RESISTOR			
C9004	1-107-645-11	ELECT	22µF 20% 200V	R9001	1-249-381-11	CARBON	1 5% 1/4W
C9006	1-162-114-00	CERAMIC	4700pF 1KV	R9002	1-216-820-11	METAL CHIP	820 5% 1/10W
C9007	1-164-156-11	CERAMIC CHIP	0.1µF 25V	R9003	1-216-819-11	METAL CHIP	680 5% 1/10W
C9008	1-126-964-11	ELECT	10µF 20% 50V	R9004	1-216-834-11	METAL CHIP	12K 5% 1/10W
C9009	1-107-636-11	ELECT	10µF 20% 160V	R9005	1-216-839-11	METAL CHIP	33K 5% 1/10W
C9010	1-137-528-11	MYLAR	0.1µF 10% 250V	R9006	1-216-811-11	METAL CHIP	150 5% 1/10W
C9011	1-107-826-11	CERAMIC CHIP	0.1µF 10% 16V	R9008	1-216-815-11	METAL CHIP	330 5% 1/10W
C9012	1-137-528-11	MYLAR	0.1µF 10% 250V	R9009	1-216-813-11	METAL CHIP	220 5% 1/10W
C9013	1-164-156-11	CERAMIC CHIP	0.1µF 25V	R9010	1-216-813-11	METAL CHIP	220 5% 1/10W
C9014	1-117-450-11	MYLAR	0.47µF 10% 250V	R9011	1-249-391-11	CARBON	6.8 5% 1/4W
CONNECTOR				R9012	1-249-391-11	CARBON	6.8 5% 1/4W
* CN9001	1-564-508-11	PLUG, CONNECTOR	5P	R9013	1-249-391-11	CARBON	6.8 5% 1/4W
* CN9002	1-564-506-11	PLUG, CONNECTOR	3P	R9014	1-249-391-11	CARBON	6.8 5% 1/4W
* CN9003	1-770-723-11	CONNECTOR, BOARD TO BOARD	8P	R9015	1-249-391-11	CARBON	6.8 5% 1/4W
FERRITE BEAD				R9016	1-249-391-11	CARBON	6.8 5% 1/4W
FB9001	1-469-869-21	FERRITE	0µH	R9017	1-249-391-11	CARBON	6.8 5% 1/4W
FB9002	1-469-869-21	FERRITE	0µH	R9018	1-249-391-11	CARBON	6.8 5% 1/4W
CHIP CONDUCTOR				R9019	1-216-848-11	METAL CHIP	180K 5% 1/10W
JR9001	1-216-864-11	SHORT CHIP		R9020	1-216-829-11	METAL CHIP	4.7K 5% 1/10W
JR9002	1-216-864-11	SHORT CHIP		R9021	1-216-805-11	METAL CHIP	47 5% 1/10W
TRANSISTOR				R9022	1-216-805-11	METAL CHIP	47 5% 1/10W
Q9001	8-729-422-27	TRANSISTOR	2SD601A-Q	R9023	1-216-829-11	METAL CHIP	4.7K 5% 1/10W
Q9002	8-729-422-27	TRANSISTOR	2SD601A-Q	R9024	1-216-848-11	METAL CHIP	180K 5% 1/10W
Q9003	8-729-422-27	TRANSISTOR	2SD601A-Q	R9025	1-243-572-71	METAL OXIDE	470 5% 2W
Q9004	8-729-424-02	TRANSISTOR	2SB709A-QRS-TX	R9026	1-216-847-11	METAL CHIP	150K 5% 1/10W
Q9005	8-729-422-27	TRANSISTOR	2SD601A-Q	R9027	1-216-847-11	METAL CHIP	150K 5% 1/10W



*

A-1065-547-A A BOARD, COMPLETE
 4-382-854-11 SCREW (M3X10), P, SW (+)

CAPACITOR

REF. NO.	PART NO.	DESCRIPTION	VALUES		
C8	1-125-837-91	CERAMIC CHIP	1 μ F	10%	6.3V
C11	1-117-720-11	CERAMIC CHIP	4.7 μ F		10V
C12	1-107-826-11	CERAMIC CHIP	0.1 μ F	10%	16V
C13	1-117-720-11	CERAMIC CHIP	4.7 μ F		10V
C14	1-117-720-11	CERAMIC CHIP	4.7 μ F		10V
C15	1-107-826-11	CERAMIC CHIP	0.1 μ F	10%	16V
C16	1-117-720-11	CERAMIC CHIP	4.7 μ F		10V
C17	1-117-720-11	CERAMIC CHIP	4.7 μ F		10V
C19	1-165-176-11	CERAMIC CHIP	0.047 μ F	10%	16V
C21	1-165-908-11	CERAMIC CHIP	1 μ F	10%	10V
C22	1-165-908-11	CERAMIC CHIP	1 μ F	10%	10V
C23	1-165-908-11	CERAMIC CHIP	1 μ F	10%	10V
C24	1-165-908-11	CERAMIC CHIP	1 μ F	10%	10V
C25	1-165-908-11	CERAMIC CHIP	1 μ F	10%	10V
C26	1-165-908-11	CERAMIC CHIP	1 μ F	10%	10V
C27	1-164-230-11	CERAMIC CHIP	220pF	5%	50V
C32	1-125-837-91	CERAMIC CHIP	1 μ F	10%	6.3V
C33	1-125-837-91	CERAMIC CHIP	1 μ F	10%	6.3V
C34	1-117-720-11	CERAMIC CHIP	4.7 μ F		10V
C35	1-107-826-11	CERAMIC CHIP	0.1 μ F	10%	16V
C36	1-117-720-11	CERAMIC CHIP	4.7 μ F		10V
C39	1-107-826-11	CERAMIC CHIP	0.1 μ F	10%	16V
C40	1-162-913-11	CERAMIC CHIP	8pF	0.50pF	50V
C41	1-107-826-11	CERAMIC CHIP	0.1 μ F	10%	16V
C42	1-162-913-11	CERAMIC CHIP	8pF	0.50pF	50V
C43	1-162-970-11	CERAMIC CHIP	0.01 μ F	10%	25V
C45	1-117-720-11	CERAMIC CHIP	4.7 μ F		10V
C49	1-164-315-11	CERAMIC CHIP	470pF	5%	50V
C50	1-126-933-11	ELECT	100 μ F	20%	16V
C52	1-126-964-11	ELECT	10 μ F	20%	50V
C53	1-107-826-11	CERAMIC CHIP	0.1 μ F	10%	16V
C54	1-165-176-11	CERAMIC CHIP	0.047 μ F	10%	16V
C57	1-125-837-91	CERAMIC CHIP	1 μ F	10%	6.3V
C58	1-164-230-11	CERAMIC CHIP	220pF	5%	50V
C60	1-107-826-11	CERAMIC CHIP	0.1 μ F	10%	16V

REF. NO.	PART NO.	DESCRIPTION	VALUES		
C62	1-126-925-91	ELECT	470 μ F	20%	10V
C63	1-126-947-11	ELECT	47 μ F	20%	35V
C64	1-126-967-11	ELECT	47 μ F	20%	50V
C65	1-126-933-11	ELECT	100 μ F	20%	16V
C66	1-164-315-11	CERAMIC CHIP	470pF	5%	50V
C67	1-164-315-11	CERAMIC CHIP	470pF	5%	50V
C68	1-164-315-11	CERAMIC CHIP	470pF	5%	50V
C69	1-107-826-11	CERAMIC CHIP	0.1 μ F	10%	16V
C70	1-107-826-11	CERAMIC CHIP	0.1 μ F	10%	16V
C71	1-126-925-91	ELECT	470 μ F	20%	10V
C72	1-107-826-11	CERAMIC CHIP	0.1 μ F	10%	16V
C73	1-117-720-11	CERAMIC CHIP	4.7 μ F		10V
C74	1-107-826-11	CERAMIC CHIP	0.1 μ F	10%	16V
C75	1-107-826-11	CERAMIC CHIP	0.1 μ F	10%	16V
C76	1-107-826-11	CERAMIC CHIP	0.1 μ F	10%	16V
C77	1-107-826-11	CERAMIC CHIP	0.1 μ F	10%	16V
C78	1-126-933-11	ELECT	100 μ F	20%	16V
C79	1-107-826-11	CERAMIC CHIP	0.1 μ F	10%	16V
C80	1-107-826-11	CERAMIC CHIP	0.1 μ F	10%	16V
C81	1-126-935-11	ELECT	470 μ F	20%	16V
C82	1-165-908-11	CERAMIC CHIP	1 μ F	10%	10V
C83	1-107-826-11	CERAMIC CHIP	0.1 μ F	10%	16V
C84	1-165-908-11	CERAMIC CHIP	1 μ F	10%	10V
C85	1-109-982-11	CERAMIC CHIP	1 μ F	10%	10V
C86	1-126-925-91	ELECT	470 μ F	20%	10V
C87	1-165-908-11	CERAMIC CHIP	1 μ F	10%	10V
C88	1-162-970-11	CERAMIC CHIP	0.01 μ F	10%	25V
C89	1-165-908-11	CERAMIC CHIP	1 μ F	10%	10V
C90	1-107-826-11	CERAMIC CHIP	0.1 μ F	10%	16V
C91	1-135-834-91	CERAMIC CHIP	2.2 μ F		
C92	1-135-834-91	CERAMIC CHIP	2.2 μ F		
C95	1-126-935-11	ELECT	470 μ F	20%	16V
C96	1-107-826-11	CERAMIC CHIP	0.1 μ F	10%	16V
C97	1-107-826-11	CERAMIC CHIP	0.1 μ F	10%	16V
C98	1-107-826-11	CERAMIC CHIP	0.1 μ F	10%	16V
C99	1-164-505-11	CERAMIC CHIP	2.2 μ F		16V
C100	1-164-505-11	CERAMIC CHIP	2.2 μ F		16V
C101	1-117-720-11	CERAMIC CHIP	4.7 μ F		10V
C106	1-164-505-11	CERAMIC CHIP	2.2 μ F		16V
C107	1-126-933-11	ELECT	100 μ F	20%	16V
C108	1-164-156-11	CERAMIC CHIP	0.1 μ F		25V
C109	1-164-505-11	CERAMIC CHIP	2.2 μ F		16V
C110	1-164-505-11	CERAMIC CHIP	2.2 μ F		16V
C111	1-164-505-11	CERAMIC CHIP	2.2 μ F		16V



REF. NO.	PART NO.	DESCRIPTION	VALUES			REF. NO.	PART NO.	DESCRIPTION	VALUES		
C112	1-117-720-11	CERAMIC CHIP	4.7μF		10V	C343	1-126-926-11	ELECT	1000μF	20%	10V
C113	1-117-720-11	CERAMIC CHIP	4.7μF		10V	C344	1-126-935-11	ELECT	470μF	20%	16V
C114	1-126-960-11	ELECT	1μF	20%	50V	C345	1-164-156-11	CERAMIC CHIP	0.1μF		25V
C115	1-126-960-11	ELECT	1μF	20%	50V	C346	1-164-156-11	CERAMIC CHIP	0.1μF		25V
C116	1-107-826-11	CERAMIC CHIP	0.1μF	10%	16V	C347	1-107-826-11	CERAMIC CHIP	0.1μF	10%	16V
C117	1-126-933-11	ELECT	100μF	20%	16V	C350	1-126-933-11	ELECT	100μF	20%	16V
C118	1-126-964-11	ELECT	10μF	20%	50V	C351	1-164-156-11	CERAMIC CHIP	0.1μF		25V
C119	1-126-964-11	ELECT	10μF	20%	50V	C352	1-107-826-11	CERAMIC CHIP	0.1μF	10%	16V
C120	1-164-156-11	CERAMIC CHIP	0.1μF		25V	C353	1-107-826-11	CERAMIC CHIP	0.1μF	10%	16V
C121	1-126-960-11	ELECT	1μF	20%	50V	C354	1-164-156-11	CERAMIC CHIP	0.1μF		25V
C123	1-165-908-11	CERAMIC CHIP	1μF	10%	10V	C355	1-126-933-11	ELECT	100μF	20%	16V
C124	1-165-908-11	CERAMIC CHIP	1μF	10%	10V	C356	1-164-156-11	CERAMIC CHIP	0.1μF		25V
C125	1-165-908-11	CERAMIC CHIP	1μF	10%	10V	C357	1-164-156-11	CERAMIC CHIP	0.1μF		25V
C126	1-165-908-11	CERAMIC CHIP	1μF	10%	10V	C360	1-126-933-11	ELECT	100μF	20%	16V
C127	1-165-908-11	CERAMIC CHIP	1μF	10%	10V	C361	1-107-826-11	CERAMIC CHIP	0.1μF	10%	16V
C128	1-165-908-11	CERAMIC CHIP	1μF	10%	10V	C363	1-162-917-11	CERAMIC CHIP	15pF	5%	50V
C131	1-126-960-11	ELECT	1μF	20%	50V	C364	1-162-917-11	CERAMIC CHIP	15pF	5%	50V
C132	1-126-933-11	ELECT	100μF	20%	16V	C365	1-164-156-11	CERAMIC CHIP	0.1μF		25V
C133	1-126-933-11	ELECT	100μF	20%	16V	C366	1-164-156-11	CERAMIC CHIP	0.1μF		25V
C134	1-126-933-11	ELECT	100μF	20%	16V	C376	1-107-826-11	CERAMIC CHIP	0.1μF	10%	16V
C135	1-126-933-11	ELECT	100μF	20%	16V	C377	1-164-315-11	CERAMIC CHIP	470pF	5%	50V
C136	1-126-933-11	ELECT	100μF	20%	16V	C378	1-162-915-11	CERAMIC CHIP	10pF	0.50pF	50V
C137	1-126-933-11	ELECT	100μF	20%	16V	C380	1-125-891-11	CERAMIC CHIP	0.47μF	10%	10V
C138	1-107-826-11	CERAMIC CHIP	0.1μF	10%	16V	C381	1-125-891-11	CERAMIC CHIP	0.47μF	10%	10V
C139	1-126-933-11	ELECT	100μF	20%	16V	C382	1-125-891-11	CERAMIC CHIP	0.47μF	10%	10V
C303	1-162-917-11	CERAMIC CHIP	15pF	5%	50V	C383	1-107-826-11	CERAMIC CHIP	0.1μF	10%	16V
C304	1-126-933-11	ELECT	100μF	20%	16V	C385	1-126-933-11	ELECT	100μF	20%	16V
C305	1-164-156-11	CERAMIC CHIP	0.1μF		25V	C386	1-164-156-11	CERAMIC CHIP	0.1μF		25V
C306	1-126-964-11	ELECT	10μF	20%	50V	C392	1-126-963-11	ELECT	4.7μF	20%	50V
C317	1-128-954-11	ELECT	1000μF	20%	25V	C398	1-164-156-11	CERAMIC CHIP	0.1μF		25V
C318	1-128-954-11	ELECT	1000μF	20%	25V	C402	1-126-933-11	ELECT	100μF	20%	16V
C320	1-164-227-11	CERAMIC CHIP	0.022μF	10%	25V	C403	1-162-970-11	CERAMIC CHIP	0.01μF	10%	25V
C321	1-164-156-11	CERAMIC CHIP	0.1μF		25V	C406	1-164-156-11	CERAMIC CHIP	0.1μF		25V
C322	1-164-156-11	CERAMIC CHIP	0.1μF		25V	C408	1-125-891-11	CERAMIC CHIP	0.47μF	10%	10V
C326	1-162-964-11	CERAMIC CHIP	0.001μF	10%	50V	C412	1-107-826-11	CERAMIC CHIP	0.1μF	10%	16V
C328	1-128-954-11	ELECT	1000μF	20%	25V	C415	1-126-963-11	ELECT	4.7μF	20%	50V
C331	1-164-156-11	CERAMIC CHIP	0.1μF		25V	C416	1-107-826-11	CERAMIC CHIP	0.1μF	10%	16V
C332	1-164-156-11	CERAMIC CHIP	0.1μF		25V	C418	1-107-826-11	CERAMIC CHIP	0.1μF	10%	16V
C334	1-164-156-11	CERAMIC CHIP	0.1μF		25V	C420	1-162-970-11	CERAMIC CHIP	0.01μF	10%	25V
C336	1-164-156-11	CERAMIC CHIP	0.1μF		25V	C425	1-125-891-11	CERAMIC CHIP	0.47μF	10%	10V
C337	1-128-942-31	ELECT	1000μF	20%	6.3V	C426	1-162-927-11	CERAMIC CHIP	100pF	5%	50V
C338	1-128-945-31	ELECT	1000μF	20%	10V	C427	1-162-919-11	CERAMIC CHIP	22pF	5%	50V
C339	1-128-950-31	ELECT	1000μF	20%	16V	C433	1-162-970-11	CERAMIC CHIP	0.01μF	10%	25V
C342	1-126-916-11	ELECT	1000μF	20%	6.3V	C434	1-162-970-11	CERAMIC CHIP	0.01μF	10%	25V



REF. NO.	PART NO.	DESCRIPTION	VALUES			REF. NO.	PART NO.	DESCRIPTION	VALUES		
C435	1-162-970-11	CERAMIC CHIP	0.01μF	10%	25V	C497	1-126-963-11	ELECT	4.7μF	20%	50V
C436	1-162-927-11	CERAMIC CHIP	100pF	5%	50V	C501	1-107-826-11	CERAMIC CHIP	0.1μF	10%	16V
C437	1-162-927-11	CERAMIC CHIP	100pF	5%	50V	C502	1-107-826-11	CERAMIC CHIP	0.1μF	10%	16V
C438	1-162-927-11	CERAMIC CHIP	100pF	5%	50V	C503	1-107-826-11	CERAMIC CHIP	0.1μF	10%	16V
C451	1-162-970-11	CERAMIC CHIP	0.01μF	10%	25V	C504	1-164-156-11	CERAMIC CHIP	0.1μF		25V
C452	1-126-960-11	ELECT	1μF	20%	50V	C505	1-164-156-11	CERAMIC CHIP	0.1μF		25V
C455	1-126-933-11	ELECT	100μF	20%	16V	C506	1-126-933-11	ELECT	100μF	20%	16V
C456	1-162-970-11	CERAMIC CHIP	0.01μF	10%	25V	C507	1-126-933-11	ELECT	100μF	20%	16V
C457	1-126-933-11	ELECT	100μF	20%	16V	C508	1-107-826-11	CERAMIC CHIP	0.1μF	10%	16V
C458	1-164-156-11	CERAMIC CHIP	0.1μF		25V	C509	1-126-933-11	ELECT	100μF	20%	16V
C459	1-162-970-11	CERAMIC CHIP	0.01μF	10%	25V	C510	1-127-715-91	CERAMIC CHIP	0.22μF	10%	16V
C460	1-165-733-31	ELECT	100μF	20%	25V	C511	1-164-156-11	CERAMIC CHIP	0.1μF		25V
C461	1-162-964-11	CERAMIC CHIP	0.001μF	10%	50V	C512	1-110-563-11	CERAMIC CHIP	0.068μF	10%	16V
C462	1-162-970-11	CERAMIC CHIP	0.01μF	10%	25V	C513	1-164-156-11	CERAMIC CHIP	0.1μF		25V
C463	1-127-715-91	CERAMIC CHIP	0.22μF	10%	16V	C514	1-162-966-11	CERAMIC CHIP	0.0022μF	10%	50V
C464	1-164-156-11	CERAMIC CHIP	0.1μF		25V	C515	1-164-156-11	CERAMIC CHIP	0.1μF		25V
C465	1-107-826-11	CERAMIC CHIP	0.1μF	10%	16V	C516	1-126-933-11	ELECT	100μF	20%	16V
C466	1-125-891-11	CERAMIC CHIP	0.47μF	10%	10V	C517	1-107-826-11	CERAMIC CHIP	0.1μF	10%	16V
C467	1-126-933-11	ELECT	100μF	20%	16V	C518	1-126-933-11	ELECT	100μF	20%	16V
C468	1-164-156-11	CERAMIC CHIP	0.1μF		25V	C519	1-126-964-11	ELECT	10μF	20%	50V
C469	1-162-964-11	CERAMIC CHIP	0.001μF	10%	50V	C523	1-164-156-11	CERAMIC CHIP	0.1μF		25V
C470	1-126-933-11	ELECT	100μF	20%	16V	C524	1-126-933-11	ELECT	100μF	20%	16V
C471	1-162-968-11	CERAMIC CHIP	0.0047μF	10%	50V	C525	1-164-156-11	CERAMIC CHIP	0.1μF		25V
C472	1-162-970-11	CERAMIC CHIP	0.01μF	10%	25V	C530	1-126-964-11	ELECT	10μF	20%	50V
C474	1-107-826-11	CERAMIC CHIP	0.1μF	10%	16V	C601	1-100-158-91	CERAMIC CHIP	1000pF	5%	100V
C475	1-126-935-11	ELECT	470μF	20%	16V	C602	1-126-041-11	ELECT	2200μF	20%	35V
C476	1-107-826-11	CERAMIC CHIP	0.1μF	10%	16V	C603	1-126-041-11	ELECT	2200μF	20%	35V
C477	1-126-933-11	ELECT	100μF	20%	16V	C604	1-164-156-11	CERAMIC CHIP	0.1μF		25V
C478	1-164-156-11	CERAMIC CHIP	0.1μF		25V	C605	1-164-156-11	CERAMIC CHIP	0.1μF		25V
C479	1-107-826-11	CERAMIC CHIP	0.1μF	10%	16V	C606	1-137-190-91	FILM	0.22μF	5%	50V
C480	1-107-826-11	CERAMIC CHIP	0.1μF	10%	16V	C607	1-162-964-11	CERAMIC CHIP	0.001μF	10%	50V
C481	1-162-970-11	CERAMIC CHIP	0.01μF	10%	25V	C609	1-164-363-11	CERAMIC CHIP	560pF	5%	50V
C482	1-126-962-11	ELECT	3.3μF	20%	50V	C611	1-162-966-11	CERAMIC CHIP	0.0022μF	10%	50V
C483	1-125-891-11	CERAMIC CHIP	0.47μF	10%	10V	C612	1-136-497-81	FILM	0.1μF	5%	50V
C484	1-162-923-11	CERAMIC CHIP	47pF	5%	50V	C613	1-164-363-11	CERAMIC CHIP	560pF	5%	50V
C485	1-125-891-11	CERAMIC CHIP	0.47μF	10%	10V	C614	1-100-158-91	CERAMIC CHIP	1000pF	5%	100V
C486	1-164-004-11	CERAMIC CHIP	0.1μF	10%	25V	C615	1-164-677-11	CERAMIC CHIP	0.033μF	10%	16V
C487	1-107-826-11	CERAMIC CHIP	0.1μF	10%	16V	C617	1-162-966-11	CERAMIC CHIP	0.0022μF	10%	50V
C488	1-164-004-11	CERAMIC CHIP	0.1μF	10%	25V	C619	1-162-966-11	CERAMIC CHIP	0.0022μF	10%	50V
C489	1-107-826-11	CERAMIC CHIP	0.1μF	10%	16V	C620	1-126-964-11	ELECT	10μF	20%	50V
C490	1-107-826-11	CERAMIC CHIP	0.1μF	10%	16V	C621	1-164-315-11	CERAMIC CHIP	470pF	5%	50V
C494	1-164-156-11	CERAMIC CHIP	0.1μF		25V	C622	1-162-975-11	CERAMIC CHIP	24pF	5%	50V
C495	1-126-963-11	ELECT	4.7μF	20%	50V	C623	1-126-947-11	ELECT	47μF	20%	35V
C496	1-126-933-11	ELECT	100μF	20%	16V	C624	1-136-497-81	FILM	0.1μF	5%	50V



REF. NO.	PART NO.	DESCRIPTION	VALUES			REF. NO.	PART NO.	DESCRIPTION	VALUES		
C625	1-164-315-11	CERAMIC CHIP	470pF	5%	50V	C671	1-136-153-00	FILM	0.01μF	5%	50V
C626	1-107-826-11	CERAMIC CHIP	0.1μF	10%	16V	C672	1-165-908-11	CERAMIC CHIP	1μF	10%	10V
C628	1-162-966-11	CERAMIC CHIP	0.0022μF	10%	50V	C673	1-137-190-91	FILM	0.22μF	5%	50V
C629	1-126-960-11	ELECT	1μF	20%	50V	C674	1-165-908-11	CERAMIC CHIP	1μF	10%	10V
C630	1-162-969-11	CERAMIC CHIP	0.0068μF	10%	25V	C675	1-136-287-11	FILM	0.0047μF	5%	100V
C631	1-162-959-11	CERAMIC CHIP	330pF	5%	50V	C676	1-162-966-11	CERAMIC CHIP	0.0022μF	10%	50V
C633	1-126-947-11	ELECT	47μF	20%	35V	C677	1-162-966-11	CERAMIC CHIP	0.0022μF	10%	50V
C634	1-164-156-11	CERAMIC CHIP	0.1μF		25V	C678	1-165-908-11	CERAMIC CHIP	1μF	10%	10V
C635	1-100-158-91	CERAMIC CHIP	1000pF	5%	100V	C679	1-165-908-11	CERAMIC CHIP	1μF	10%	10V
C636	1-137-190-91	FILM	0.22μF	5%	50V	C680	1-137-190-91	FILM	0.22μF	5%	50V
C637	1-162-959-11	CERAMIC CHIP	330pF	5%	50V	C681	1-137-365-11	MYLAR	0.0015μF	5%	50V
C638	1-164-156-11	CERAMIC CHIP	0.1μF		25V	C682	1-136-159-00	FILM	0.033μF	5%	50V
C639	1-162-969-11	CERAMIC CHIP	0.0068μF	10%	25V	C683	1-137-367-11	MYLAR	0.0033μF	5%	50V
C640	1-164-315-11	CERAMIC CHIP	470pF	5%	50V	C684	1-137-190-91	FILM	0.22μF	5%	50V
C641	1-126-960-11	ELECT	1μF	20%	50V	C685	1-164-156-11	CERAMIC CHIP	0.1μF		25V
C642	1-164-315-11	CERAMIC CHIP	470pF	5%	50V	C686	1-126-933-11	ELECT	100μF	20%	16V
C643	1-100-158-91	CERAMIC CHIP	1000pF	5%	100V	C687	1-126-933-11	ELECT	100μF	20%	16V
C644	1-126-947-11	ELECT	47μF	20%	35V	C688	1-136-177-00	FILM	1μF	5%	50V
C645	1-126-066-11	ELECT	470μF	20%	63V	C689	1-136-177-00	FILM	1μF	5%	50V
C646	1-164-363-11	CERAMIC CHIP	560pF	5%	50V	C690	1-136-497-81	FILM	0.1μF	5%	50V
C647	1-164-677-11	CERAMIC CHIP	0.033μF	10%	16V	C691	1-136-497-81	FILM	0.1μF	5%	50V
C648	1-100-158-91	CERAMIC CHIP	1000pF	5%	100V	C692	1-162-974-11	CERAMIC CHIP	0.01μF		50V
C649	1-164-363-11	CERAMIC CHIP	560pF	5%	50V	C701	1-164-156-11	CERAMIC CHIP	0.1μF		25V
C650	1-164-156-11	CERAMIC CHIP	0.1μF		25V	C702	1-162-968-11	CERAMIC CHIP	0.0047μF	10%	50V
C651	1-164-156-11	CERAMIC CHIP	0.1μF		25V	C703	1-107-826-11	CERAMIC CHIP	0.1μF	10%	16V
C652	1-164-156-11	CERAMIC CHIP	0.1μF		25V	C704	1-107-826-11	CERAMIC CHIP	0.1μF	10%	16V
C653	1-126-964-11	ELECT	10μF	20%	50V	C705	1-162-968-11	CERAMIC CHIP	0.0047μF	10%	50V
C654	1-165-908-11	CERAMIC CHIP	1μF	10%	10V	C706	1-162-963-11	CERAMIC CHIP	680pF	10%	50V
C655	1-165-908-11	CERAMIC CHIP	1μF	10%	10V	C707	1-162-963-11	CERAMIC CHIP	680pF	10%	50V
C656	1-165-908-11	CERAMIC CHIP	1μF	10%	10V	C708	1-164-156-11	CERAMIC CHIP	0.1μF		25V
C657	1-128-934-91	CERAMIC CHIP	0.33μF	20%	10V	C709	1-164-505-11	CERAMIC CHIP	2.2μF		16V
C658	1-137-190-91	FILM	0.22μF	5%	50V	C710	1-126-933-11	ELECT	100μF	20%	16V
C659	1-137-365-11	MYLAR	0.0015μF	5%	50V	C711	1-164-156-11	CERAMIC CHIP	0.1μF		25V
C660	1-136-159-00	FILM	0.033μF	5%	50V	C712	1-164-230-11	CERAMIC CHIP	220pF	5%	50V
C661	1-137-367-11	MYLAR	0.0033μF	5%	50V	C713	1-115-416-11	CERAMIC CHIP	0.001μF	5%	25V
C662	1-136-287-11	FILM	0.0047μF	5%	100V	C716	1-126-934-11	ELECT	220μF	20%	16V
C663	1-165-908-11	CERAMIC CHIP	1μF	10%	10V	C717	1-164-156-11	CERAMIC CHIP	0.1μF		25V
C664	1-136-287-11	FILM	0.0047μF	5%	100V	C718	1-115-416-11	CERAMIC CHIP	0.001μF	5%	25V
C665	1-136-153-00	FILM	0.01μF	5%	50V	C719	1-164-230-11	CERAMIC CHIP	220pF	5%	50V
C666	1-164-227-11	CERAMIC CHIP	0.022μF	10%	25V	C720	1-126-933-11	ELECT	100μF	20%	16V
C667	1-107-826-11	CERAMIC CHIP	0.1μF	10%	16V	C721	1-164-156-11	CERAMIC CHIP	0.1μF		25V
C668	1-126-933-11	ELECT	100μF	20%	16V	C722	1-164-505-11	CERAMIC CHIP	2.2μF		16V
C669	1-107-704-51	ELECT	470μF	20%	25V	C723	1-164-156-11	CERAMIC CHIP	0.1μF		25V
C670	1-165-908-11	CERAMIC CHIP	1μF	10%	10V	C724	1-162-920-11	CERAMIC CHIP	27pF	5%	50V



REF. NO.	PART NO.	DESCRIPTION	VALUES			REF. NO.	PART NO.	DESCRIPTION	VALUES		
C725	1-162-919-11	CERAMIC CHIP	22pF	5%	50V	C870	1-126-933-11	ELECT	100μF	20%	16V
C726	1-164-156-11	CERAMIC CHIP	0.1μF		25V	C871	1-107-826-11	CERAMIC CHIP	0.1μF	10%	16V
C727	1-162-918-11	CERAMIC CHIP	18pF	5%	50V	C872	1-107-826-11	CERAMIC CHIP	0.1μF	10%	16V
C728	1-162-918-11	CERAMIC CHIP	18pF	5%	50V	C873	1-107-826-11	CERAMIC CHIP	0.1μF	10%	16V
C729	1-164-156-11	CERAMIC CHIP	0.1μF		25V	C874	1-107-826-11	CERAMIC CHIP	0.1μF	10%	16V
C730	1-162-919-11	CERAMIC CHIP	22pF	5%	50V	C875	1-107-826-11	CERAMIC CHIP	0.1μF	10%	16V
C732	1-115-156-11	CERAMIC CHIP	1μF		10V	C876	1-107-826-11	CERAMIC CHIP	0.1μF	10%	16V
C733	1-115-416-11	CERAMIC CHIP	0.001μF	5%	25V	C877	1-107-826-11	CERAMIC CHIP	0.1μF	10%	16V
C734	1-164-156-11	CERAMIC CHIP	0.1μF		25V	C878	1-107-826-11	CERAMIC CHIP	0.1μF	10%	16V
C735	1-164-156-11	CERAMIC CHIP	0.1μF		25V	C879	1-107-826-11	CERAMIC CHIP	0.1μF	10%	16V
C736	1-164-156-11	CERAMIC CHIP	0.1μF		25V	C880	1-107-826-11	CERAMIC CHIP	0.1μF	10%	16V
C737	1-164-156-11	CERAMIC CHIP	0.1μF		25V	C881	1-125-837-91	CERAMIC CHIP	1μF	10%	6.3V
C738	1-126-942-61	ELECT	1000μF	20%	25V	C882	1-125-837-91	CERAMIC CHIP	1μF	10%	6.3V
C739	1-126-933-11	ELECT	100μF	20%	16V	C883	1-125-837-91	CERAMIC CHIP	1μF	10%	6.3V
C741	1-126-933-11	ELECT	100μF	20%	16V	C884	1-125-837-91	CERAMIC CHIP	1μF	10%	6.3V
C742	1-164-156-11	CERAMIC CHIP	0.1μF		25V	C885	1-125-837-91	CERAMIC CHIP	1μF	10%	6.3V
C743	1-126-933-11	ELECT	100μF	20%	16V	C886	1-125-837-91	CERAMIC CHIP	1μF	10%	6.3V
C744	1-164-156-11	CERAMIC CHIP	0.1μF		25V	C887	1-107-826-11	CERAMIC CHIP	0.1μF	10%	16V
C745	1-162-916-11	CERAMIC CHIP	12pF	5%	50V	C888	1-125-837-91	CERAMIC CHIP	1μF	10%	6.3V
C746	1-162-916-11	CERAMIC CHIP	12pF	5%	50V	C889	1-107-826-11	CERAMIC CHIP	0.1μF	10%	16V
C747	1-162-907-11	CERAMIC CHIP	2pF	0.25pF	50V	C890	1-107-826-11	CERAMIC CHIP	0.1μF	10%	16V
C748	1-164-245-11	CERAMIC CHIP	0.015μF	10%	25V	C891	1-126-933-11	ELECT	100μF	20%	16V
C750	1-164-156-11	CERAMIC CHIP	0.1μF		25V	C892	1-107-826-11	CERAMIC CHIP	0.1μF	10%	16V
C751	1-115-416-11	CERAMIC CHIP	0.001μF	5%	25V	C893	1-125-837-91	CERAMIC CHIP	1μF	10%	6.3V
C752	1-164-156-11	CERAMIC CHIP	0.1μF		25V	C894	1-107-826-11	CERAMIC CHIP	0.1μF	10%	16V
C753	1-126-933-11	ELECT	100μF	20%	16V	C895	1-162-915-11	CERAMIC CHIP	10pF	0.50pF	50V
C760	1-126-925-91	ELECT	470μF	20%	10V	C896	1-162-915-11	CERAMIC CHIP	10pF	0.50pF	50V
C851	1-107-826-11	CERAMIC CHIP	0.1μF	10%	16V	C897	1-125-837-91	CERAMIC CHIP	1μF	10%	6.3V
C852	1-164-392-11	CERAMIC CHIP	390pF	5%	50V	C898	1-125-837-91	CERAMIC CHIP	1μF	10%	6.3V
C853	1-107-826-11	CERAMIC CHIP	0.1μF	10%	16V	C899	1-107-826-11	CERAMIC CHIP	0.1μF	10%	16V
C854	1-107-826-11	CERAMIC CHIP	0.1μF	10%	16V	C900	1-107-826-11	CERAMIC CHIP	0.1μF	10%	16V
C855	1-107-826-11	CERAMIC CHIP	0.1μF	10%	16V	C901	1-107-826-11	CERAMIC CHIP	0.1μF	10%	16V
C856	1-162-927-11	CERAMIC CHIP	100pF	5%	50V	C902	1-125-837-91	CERAMIC CHIP	1μF	10%	6.3V
C857	1-162-965-11	CERAMIC CHIP	0.0015μF	10%	50V	C903	1-107-826-11	CERAMIC CHIP	0.1μF	10%	16V
C858	1-162-965-11	CERAMIC CHIP	0.0015μF	10%	50V	C904	1-125-837-91	CERAMIC CHIP	1μF	10%	6.3V
C859	1-115-416-11	CERAMIC CHIP	0.001μF	5%	25V	C906	1-125-837-91	CERAMIC CHIP	1μF	10%	6.3V
C860	1-107-826-11	CERAMIC CHIP	0.1μF	10%	16V	C907	1-125-837-91	CERAMIC CHIP	1μF	10%	6.3V
C861	1-162-965-11	CERAMIC CHIP	0.0015μF	10%	50V	C908	1-125-837-91	CERAMIC CHIP	1μF	10%	6.3V
C862	1-162-965-11	CERAMIC CHIP	0.0015μF	10%	50V	C909	1-125-837-91	CERAMIC CHIP	1μF	10%	6.3V
C863	1-164-156-11	CERAMIC CHIP	0.1μF		25V	C910	1-125-837-91	CERAMIC CHIP	1μF	10%	6.3V
C864	1-164-156-11	CERAMIC CHIP	0.1μF		25V	C912	1-164-315-11	CERAMIC CHIP	470pF	5%	50V
C865	1-162-970-11	CERAMIC CHIP	0.01μF	10%	25V	C913	1-164-315-11	CERAMIC CHIP	470pF	5%	50V
C868	1-107-826-11	CERAMIC CHIP	0.1μF	10%	16V	C914	1-164-315-11	CERAMIC CHIP	470pF	5%	50V
C869	1-107-826-11	CERAMIC CHIP	0.1μF	10%	16V	C916	1-107-826-11	CERAMIC CHIP	0.1μF	10%	16V



REF. NO.	PART NO.	DESCRIPTION	VALUES			REF. NO.	PART NO.	DESCRIPTION	VALUES
C917	1-162-925-11	CERAMIC CHIP	68pF	5%	50V	*	CN21	1-785-532-11	PIN, CONNECTOR (PC BOARD) 14P
C918	1-162-925-11	CERAMIC CHIP	68pF	5%	50V	*	CN22	1-785-530-11	PIN, CONNECTOR (PC BOARD) 10P
C919	1-162-925-11	CERAMIC CHIP	68pF	5%	50V		CN23	1-695-915-11	TAB (CONTACT)
C920	1-107-826-11	CERAMIC CHIP	0.1μF	10%	16V		CN24	1-695-915-11	TAB (CONTACT)
C921	1-107-826-11	CERAMIC CHIP	0.1μF	10%	16V		CN25	1-695-915-11	TAB (CONTACT)
C922	1-107-826-11	CERAMIC CHIP	0.1μF	10%	16V		CN26	1-785-900-21	CONNECTOR 5P
C923	1-107-826-11	CERAMIC CHIP	0.1μF	10%	16V	*	CN27	1-785-125-21	CONNECTOR 6P
C924	1-126-933-11	ELECT	100μF	20%	16V		CN28	1-785-900-21	CONNECTOR 5P
C925	1-107-826-11	CERAMIC CHIP	0.1μF	10%	16V	*	CN29	1-785-125-21	CONNECTOR 6P
C926	1-107-826-11	CERAMIC CHIP	0.1μF	10%	16V				
C927	1-107-826-11	CERAMIC CHIP	0.1μF	10%	16V				
C928	1-125-837-91	CERAMIC CHIP	1μF	10%	6.3V				
C929	1-125-837-91	CERAMIC CHIP	1μF	10%	6.3V				
C930	1-162-921-11	CERAMIC CHIP	33pF	5%	50V				
C931	1-162-921-11	CERAMIC CHIP	33pF	5%	50V				
C932	1-125-837-91	CERAMIC CHIP	1μF	10%	6.3V				
C933	1-162-921-11	CERAMIC CHIP	33pF	5%	50V				
C934	1-164-218-11	CERAMIC CHIP	180pF	5%	50V				
C935	1-164-218-11	CERAMIC CHIP	180pF	5%	50V				
C936	1-164-218-11	CERAMIC CHIP	180pF	5%	50V				
C937	1-162-970-11	CERAMIC CHIP	0.01μF	10%	25V				
C938	1-126-933-11	ELECT	100μF	20%	16V				
		CONNECTOR							
*	CN2	1-764-334-11	PIN, CONNECTOR(PCB)(V TYPE)		11P				
*	CN3	1-564-512-11	PLUG, CONNECTOR		9P				
*	CN4	1-818-480-11	PIN, CONNECTOR		12P				
	CN5	1-573-979-22	CONNECTOR, BOARD TO BOARD		11P				
*	CN6	1-779-892-11	CONNECTOR, BOARD TO BOARD		10P				
*	CN7	1-564-507-11	PLUG, CONNECTOR		4P				
*	CN8	1-779-892-11	CONNECTOR, BOARD TO BOARD		10P				
*	CN9	1-779-892-11	CONNECTOR, BOARD TO BOARD		10P				
*	CN10	1-779-892-11	CONNECTOR, BOARD TO BOARD		10P				
*	CN11	1-793-495-11	CONNECTOR, BOARD TO BOARD		50P				
*	CN12	1-764-333-11	PIN, CONNECTOR(PCB)(V TYPE)		10P				
*	CN13	1-764-334-11	PIN, CONNECTOR(PCB)(V TYPE)		11P				
*	CN14	1-564-507-11	PLUG, CONNECTOR		4P				
*	CN15	1-564-512-11	PLUG, CONNECTOR		9P				
*	CN16	1-564-507-11	PLUG, CONNECTOR		4P				
*	CN17	1-564-508-11	PLUG, CONNECTOR		5P				
*	CN18	1-564-509-11	PLUG, CONNECTOR		6P				
*	CN19	1-564-511-11	PLUG, CONNECTOR		8P				
*	CN20	1-779-892-11	CONNECTOR, BOARD TO BOARD		10P				
							DIODE		
						D2	8-719-977-28	DIODE	DTZ10B
						D3	8-719-977-28	DIODE	DTZ10B
						D4	8-719-977-28	DIODE	DTZ10B
						D5	8-719-977-28	DIODE	DTZ10B
						D6	8-719-977-28	DIODE	DTZ10B
						D7	8-719-977-28	DIODE	DTZ10B
						D8	8-719-977-28	DIODE	DTZ10B
						D9	8-719-977-28	DIODE	DTZ10B
						D10	8-719-977-28	DIODE	DTZ10B
						D11	8-719-977-28	DIODE	DTZ10B
						D12	8-719-977-28	DIODE	DTZ10B
						D13	8-719-977-28	DIODE	DTZ10B
						D14	8-719-977-28	DIODE	DTZ10B
						D15	8-719-977-28	DIODE	DTZ10B
						D16	8-719-977-28	DIODE	DTZ10B
						D17	8-719-977-28	DIODE	DTZ10B
						D18	8-719-977-28	DIODE	DTZ10B
						D19	8-719-977-28	DIODE	DTZ10B
						D20	8-719-977-28	DIODE	DTZ10B
						D21	8-719-977-28	DIODE	DTZ10B
						D23	8-719-977-28	DIODE	DTZ10B
						D24	8-719-977-28	DIODE	DTZ10B
						D25	8-719-977-28	DIODE	DTZ10B
						D26	8-719-977-28	DIODE	DTZ10B
						D27	8-719-977-28	DIODE	DTZ10B
						D28	8-719-977-28	DIODE	DTZ10B
						D35	8-719-066-11	DIODE	1PS184-115
						D36	8-719-977-28	DIODE	DTZ10B
						D37	8-719-977-28	DIODE	DTZ10B
						D38	8-719-977-28	DIODE	DTZ10B
						D39	8-719-977-28	DIODE	DTZ10B
						D40	8-719-977-28	DIODE	DTZ10B



REF. NO.	PART NO.	DESCRIPTION	VALUES	REF. NO.	PART NO.	DESCRIPTION	VALUES
D41	8-719-977-28	DIODE	DTZ10B	D856	8-719-081-97	DIODE	MMDL914T1
D42	8-719-977-28	DIODE	DTZ10B	D857	8-719-081-97	DIODE	MMDL914T1
D43	8-719-977-28	DIODE	DTZ10B	D858	8-719-081-97	DIODE	MMDL914T1
D44	8-719-081-97	DIODE	MMDL914T1				
D45	8-719-081-97	DIODE	MMDL914T1				
D304	8-719-078-04	DIODE	EC31QS03L-TE12L				
D305	8-719-078-04	DIODE	EC31QS03L-TE12L	FB301	1-412-911-11	FERRITE	0μH
D306	8-719-078-04	DIODE	EC31QS03L-TE12L	FB302	1-412-911-11	FERRITE	0μH
D307	8-719-036-94	DIODE	RD5.6SB-T1	FB303	1-412-911-11	FERRITE	0μH
D308	8-719-081-97	DIODE	MMDL914T1	FB305	1-414-445-11	FERRITE	0μH
				FB306	1-414-445-11	FERRITE	0μH
D309	8-719-081-97	DIODE	MMDL914T1				
D310	8-719-056-83	DIODE	UDZ-TE-17-6.8B	FB602	1-469-578-11	FERRITE	1.1μH
D311	8-719-081-97	DIODE	MMDL914T1	FB603	1-469-578-11	FERRITE	1.1μH
D312	8-719-977-28	DIODE	DTZ10B	FB604	1-469-578-11	FERRITE	1.1μH
D313	8-719-028-45	DIODE	D2L20U	FB605	1-469-578-11	FERRITE	1.1μH
				FB701	1-216-864-11	SHORT CHIP	
D451	6-500-654-01	DIODE	MM3Z3V0T1				
D452	8-719-081-97	DIODE	MMDL914T1	FB702	1-216-864-11	SHORT CHIP	
D453	8-719-081-97	DIODE	MMDL914T1	FB703	1-543-949-22	FERRITE	0μH
D454	8-719-081-97	DIODE	MMDL914T1	FB704	1-216-864-11	SHORT CHIP	
D456	8-719-036-94	DIODE	RD5.6SB-T1	FB705	1-216-864-11	SHORT CHIP	
				FB852	1-414-445-11	FERRITE	0μH
D457	8-719-081-97	DIODE	MMDL914T1				
D458	8-719-977-28	DIODE	DTZ10B	FB853	1-414-445-11	FERRITE	0μH
D459	8-719-081-97	DIODE	MMDL914T1	FB854	1-414-445-11	FERRITE	0μH
D460	8-719-977-28	DIODE	DTZ10B	FB855	1-414-445-11	FERRITE	0μH
D470	8-719-081-97	DIODE	MMDL914T1	FB856	1-414-445-11	FERRITE	0μH
				FB857	1-414-445-11	FERRITE	0μH
D471	8-719-081-97	DIODE	MMDL914T1				
D501	8-719-081-97	DIODE	MMDL914T1	FB858	1-414-445-11	FERRITE	0μH
D602	6-500-028-01	DIODE	MM3Z9V1ST1	FB859	1-414-445-11	FERRITE	0μH
D603	1-216-295-91	SHORT CHIP		FB860	1-414-445-11	FERRITE	0μH
D701	8-719-066-11	DIODE	1PS184-115	FB861	1-414-445-11	FERRITE	0μH
				FB862	1-414-445-11	FERRITE	0μH
D703	8-719-081-97	DIODE	MMDL914T1				
D706	8-719-083-57	DIODE	UDZSTE-173.6B	FB863	1-414-445-11	FERRITE	0μH
D707	8-719-081-97	DIODE	MMDL914T1	FB864	1-414-445-11	FERRITE	0μH
D708	8-719-066-11	DIODE	1PS184-115	FB865	1-414-445-11	FERRITE	0μH
D709	8-719-066-11	DIODE	1PS184-115	FB866	1-414-445-11	FERRITE	0μH
				FB867	1-414-445-11	FERRITE	0μH
D711	8-719-081-97	DIODE	MMDL914T1				
D712	8-719-081-97	DIODE	MMDL914T1	FB868	1-414-445-11	FERRITE	0μH
D720	8-719-066-11	DIODE	1PS184-115	FB869	1-414-445-11	FERRITE	0μH
D721	8-719-081-97	DIODE	MMDL914T1	FB870	1-414-445-11	FERRITE	0μH
D851	8-719-976-99	DIODE	DTZ5.1B	FB871	1-414-445-11	FERRITE	0μH
				FB872	1-414-445-11	FERRITE	0μH
D852	8-719-976-99	DIODE	DTZ5.1B				
D853	8-719-976-99	DIODE	DTZ5.1B	FB873	1-414-445-11	FERRITE	0μH
D854	8-719-976-99	DIODE	DTZ5.1B	FB874	1-414-445-11	FERRITE	0μH
D855	8-719-081-97	DIODE	MMDL914T1	FB875	1-414-445-11	FERRITE	0μH





REF. NO.	PART NO.	DESCRIPTION	VALUES	REF. NO.	PART NO.	DESCRIPTION	VALUES
FB876	1-414-445-11	FERRITE	0μH	IC857	6-704-067-01	IC	M24128-BWMN6T(A)
FB877	1-414-445-11	FERRITE	0μH	IC858	8-759-352-91	IC	PST9143NL
FB878	1-414-445-11	FERRITE	0μH	IC859	8-759-700-65	IC	NJM79L05A
FB879	1-414-445-11	FERRITE	0μH	IC860	8-759-830-08	IC	NJM2068V-TE2
FB880	1-414-445-11	FERRITE	0μH	IC861	8-759-830-08	IC	NJM2068V-TE2
FB882	1-414-445-11	FERRITE	0μH	IC862	8-759-830-08	IC	NJM2068V-TE2
FB883	1-414-445-11	FERRITE	0μH				
	FILTER				JACK		
FL302	1-239-848-21	FILTER, LOW PASS		J1	1-780-168-11	TERMINAL BLOCK, S	8P
FL305	1-239-848-21	FILTER, LOW PASS		J3	1-794-118-11	JACK BLOCK, PIN	3P
FL306	1-239-848-21	FILTER, LOW PASS		J5	1-794-116-11	JACK BLOCK, PIN	2P
				* J6	1-818-012-11	PIN JACK BLOCK	10P
				J8	1-565-790-21	JACK, SMALL TYPE	2P
	IC				COIL		
IC1	8-753-204-12	IC	CXA2209Q-T6	L6	1-400-397-11	INDUCTOR	10μH
IC2	8-752-107-98	IC	CXA2188Q-T4	L8	1-414-856-11	INDUCTOR	10μH
IC3	8-759-443-11	IC	NJM2283M-TE1	L9	1-414-856-11	INDUCTOR	10μH
IC4	8-759-278-58	IC	NJM4558V-TE2	L10	1-414-856-11	INDUCTOR	10μH
IC302	8-759-659-28	IC	SI-8033S	L11	1-414-856-11	INDUCTOR	10μH
IC303	8-759-474-09	IC	SI-8050S-LF1101	L12	1-400-397-11	INDUCTOR	10μH
IC304	6-703-656-01	IC	SI-8090S	L13	1-400-397-11	INDUCTOR	10μH
IC305	8-752-394-69	IC	CXD2073Q-T4	L14	1-400-397-11	INDUCTOR	10μH
IC306	8-752-102-21	IC	CXA2103AQ	L15	1-400-397-11	INDUCTOR	10μH
IC451	6-706-445-01	IC	NJM2880U1-05-TE1	L16	1-400-397-11	INDUCTOR	10μH
IC452	8-752-102-68	IC	CXA2170Q	L17	1-400-397-11	INDUCTOR	10μH
IC601	6-704-233-01	IC	TDA7490	L302	1-400-397-11	INDUCTOR	10μH
IC602	8-759-278-58	IC	NJM4558V-TE2	L306	1-412-537-31	INDUCTOR	100μH
IC603	6-704-236-01	IC	NJW1148	L307	1-412-525-31	INDUCTOR	10μH
IC604	8-759-569-92	IC	NJM2370U09-TE2	L308	1-412-525-31	INDUCTOR	10μH
IC701	6-706-444-01	IC	NJM2880U1-33-TE1	L310	1-456-414-11	COIL, CHOPPER	
IC702	6-802-654-01	IC	M306V7FGFP	L311	1-456-414-11	COIL, CHOPPER	
IC703	6-801-375-01	IC	PST9129NL	L312	1-456-414-11	COIL, CHOPPER	
IC704	6-704-573-01	IC	M24C32-WMN6T(B)	L313	1-412-525-31	INDUCTOR	10μH
IC705	6-804-751-01	IC	M306VSMG-539FP	L314	1-412-525-31	INDUCTOR	10μH
IC706	8-759-488-29	IC	TC7W66FU(TE12R)	L315	1-412-525-31	INDUCTOR	10μH
IC707	6-704-573-01	IC	M24C32-WMN6T(B)	L316	1-400-397-11	INDUCTOR	10μH
IC851	8-759-830-08	IC	NJM2068V-TE2	L317	1-400-397-11	INDUCTOR	10μH
IC852	8-759-278-58	IC	NJM4558V-TE2	L320	1-400-397-11	INDUCTOR	10μH
IC853	8-759-278-58	IC	NJM4558V-TE2	L323	1-400-397-11	INDUCTOR	10μH
IC854	8-759-641-26	IC	NJM2391DL1-33(TE1)	L451	1-400-397-11	INDUCTOR	10μH
IC855	6-704-266-01	IC	CM0033AF	L452	1-400-397-11	INDUCTOR	10μH
IC856	8-753-224-46	IC	CXP86460-653Q	L453	1-400-397-11	INDUCTOR	10μH

NOTE: The components identified by shading and  mark are critical for safety. Replace only with part number specified.

NOTE: Les composants identifiés par un trame et une  sont critiques pour la sécurité. Ne les remplacer que par une pièce portant le numéro spécifique.



REF. NO.	PART NO.	DESCRIPTION	VALUES	REF. NO.	PART NO.	DESCRIPTION	VALUES
L454	1-469-559-21	INDUCTOR	47µH	Q31	8-729-010-25	TRANSISTOR	MSD601-RT1
L455	1-400-397-11	INDUCTOR	10µH	Q32	8-729-010-25	TRANSISTOR	MSD601-RT1
L456	1-400-397-11	INDUCTOR	10µH	Q33	8-729-010-05	TRANSISTOR	MSB709-RT1
L457	1-400-397-11	INDUCTOR	10µH	Q34	8-729-010-25	TRANSISTOR	MSD601-RT1
L458	1-400-397-11	INDUCTOR	10µH	Q35	8-729-010-25	TRANSISTOR	MSD601-RT1
L459	1-400-397-11	INDUCTOR	10µH	Q36	8-729-010-05	TRANSISTOR	MSB709-RT1
L601	1-456-621-11	INDUCTOR	35µH	Q304	8-729-010-05	TRANSISTOR	MSB709-RT1
L602	1-456-620-11	INDUCTOR	25µH	Q306	8-729-010-25	TRANSISTOR	MSD601-RT1
L603	1-456-620-11	INDUCTOR	25µH	Q308	8-729-010-05	TRANSISTOR	MSB709-RT1
L604	1-456-621-11	INDUCTOR	35µH	Q311	8-729-010-25	TRANSISTOR	MSD601-RT1
L701	1-400-397-11	INDUCTOR	10µH	Q312	8-729-010-05	TRANSISTOR	MSB709-RT1
L702	1-400-397-11	INDUCTOR	10µH	Q313	8-729-010-25	TRANSISTOR	MSD601-RT1
L703	1-412-943-11	INDUCTOR	2.2µH	Q322	8-729-010-25	TRANSISTOR	MSD601-RT1
L704	1-400-397-11	INDUCTOR	10µH	Q323	8-729-010-25	TRANSISTOR	MSD601-RT1
L705	1-400-397-11	INDUCTOR	10µH	Q324	8-729-010-25	TRANSISTOR	MSD601-RT1
L851	1-469-552-21	INDUCTOR	3.3µH	Q325	8-729-010-25	TRANSISTOR	MSD601-RT1
IC LINK				Q451	8-729-010-05	TRANSISTOR	MSB709-RT1
PS1	1-532-679-00	IC LINK	0.6A 50V	Q452	8-729-010-25	TRANSISTOR	MSD601-RT1
 PS600	1-576-390-91	IC LINK	2.5A 50V	Q453	8-729-010-25	TRANSISTOR	MSD601-RT1
 PS601	1-576-390-91	IC LINK	2.5A 50V	Q454	8-729-010-25	TRANSISTOR	MSD601-RT1
TRANSISTOR				Q455	8-729-010-25	TRANSISTOR	MSD601-RT1
Q2	8-729-010-05	TRANSISTOR	MSB709-RT1	Q456	8-729-010-25	TRANSISTOR	MSD601-RT1
Q5	8-729-010-25	TRANSISTOR	MSD601-RT1	Q457	8-729-010-25	TRANSISTOR	MSD601-RT1
Q6	8-729-010-05	TRANSISTOR	MSB709-RT1	Q458	8-729-010-25	TRANSISTOR	MSD601-RT1
Q7	8-729-010-25	TRANSISTOR	MSD601-RT1	Q459	8-729-010-25	TRANSISTOR	MSD601-RT1
Q9	8-729-010-25	TRANSISTOR	MSD601-RT1	Q460	8-729-010-25	TRANSISTOR	MSD601-RT1
Q10	8-729-010-05	TRANSISTOR	MSB709-RT1	Q461	8-729-122-63	TRANSISTOR	2SA1226-E4
Q12	8-729-010-05	TRANSISTOR	MSB709-RT1	Q462	8-729-010-05	TRANSISTOR	MSB709-RT1
Q13	8-729-010-05	TRANSISTOR	MSB709-RT1	Q463	8-729-010-05	TRANSISTOR	MSB709-RT1
Q14	8-729-010-05	TRANSISTOR	MSB709-RT1	Q464	8-729-010-25	TRANSISTOR	MSD601-RT1
Q16	8-729-010-05	TRANSISTOR	MSB709-RT1	Q465	8-729-010-05	TRANSISTOR	MSB709-RT1
Q20	8-729-010-25	TRANSISTOR	MSD601-RT1	Q466	8-729-010-25	TRANSISTOR	MSD601-RT1
Q21	8-729-010-05	TRANSISTOR	MSB709-RT1	Q467	8-729-010-25	TRANSISTOR	MSD601-RT1
Q23	8-729-010-05	TRANSISTOR	MSB709-RT1	Q468	8-729-010-25	TRANSISTOR	MSD601-RT1
Q24	8-729-122-63	TRANSISTOR	2SA1226-E4	Q469	8-729-010-05	TRANSISTOR	MSB709-RT1
Q25	8-729-122-63	TRANSISTOR	2SA1226-E4	Q470	8-729-010-05	TRANSISTOR	MSB709-RT1
Q26	8-729-122-63	TRANSISTOR	2SA1226-E4	Q471	8-729-010-05	TRANSISTOR	MSB709-RT1
Q27	8-729-010-05	TRANSISTOR	MSB709-RT1	Q472	8-729-010-25	TRANSISTOR	MSD601-RT1
Q28	8-729-010-25	TRANSISTOR	MSD601-RT1	Q473	8-729-122-63	TRANSISTOR	2SA1226-E4
Q29	8-729-010-25	TRANSISTOR	MSD601-RT1	Q474	8-729-122-63	TRANSISTOR	2SA1226-E4
Q30	8-729-010-05	TRANSISTOR	MSB709-RT1	Q476	8-729-122-63	TRANSISTOR	2SA1226-E4
				Q477	8-729-028-97	TRANSISTOR	DTC114TUA-T106
				Q478	8-729-028-97	TRANSISTOR	DTC114TUA-T106
				Q479	8-729-028-97	TRANSISTOR	DTC114TUA-T106



REF. NO.	PART NO.	DESCRIPTION	VALUES	REF. NO.	PART NO.	DESCRIPTION	VALUES
Q481	8-729-010-25	TRANSISTOR	MSD601-RT1	RESISTOR			
Q482	8-729-010-25	TRANSISTOR	MSD601-RT1	R1	1-216-829-11	METAL CHIP	4.7K 5% 1/10W
Q483	8-729-010-25	TRANSISTOR	MSD601-RT1	R4	1-216-833-11	METAL CHIP	10K 5% 1/10W
Q484	8-729-010-25	TRANSISTOR	MSD601-RT1	R5	1-216-833-11	METAL CHIP	10K 5% 1/10W
Q485	8-729-010-25	TRANSISTOR	MSD601-RT1	R6	1-216-853-11	METAL CHIP	470K 5% 1/10W
Q486	8-729-010-05	TRANSISTOR	MSB709-RT1	R7	1-218-285-11	METAL CHIP	75 5% 1/10W
Q487	8-729-010-05	TRANSISTOR	MSB709-RT1	R8	1-218-285-11	METAL CHIP	75 5% 1/10W
Q488	8-729-010-05	TRANSISTOR	MSB709-RT1	R9	1-218-285-11	METAL CHIP	75 5% 1/10W
Q601	8-729-010-25	TRANSISTOR	MSD601-RT1	R10	1-216-853-11	METAL CHIP	470K 5% 1/10W
Q603	8-729-010-25	TRANSISTOR	MSD601-RT1	R11	1-216-853-11	METAL CHIP	470K 5% 1/10W
Q604	8-729-010-25	TRANSISTOR	MSD601-RT1	R12	1-218-285-11	METAL CHIP	75 5% 1/10W
Q605	8-729-010-05	TRANSISTOR	MSB709-RT1	R13	1-218-285-11	METAL CHIP	75 5% 1/10W
Q701	8-729-010-25	TRANSISTOR	MSD601-RT1	R14	1-218-285-11	METAL CHIP	75 5% 1/10W
Q702	8-729-010-25	TRANSISTOR	MSD601-RT1	R17	1-216-853-11	METAL CHIP	470K 5% 1/10W
Q703	8-729-010-25	TRANSISTOR	MSD601-RT1	R18	1-216-853-11	METAL CHIP	470K 5% 1/10W
Q706	8-729-010-25	TRANSISTOR	MSD601-RT1	R19	1-218-285-11	METAL CHIP	75 5% 1/10W
Q707	8-729-010-25	TRANSISTOR	MSD601-RT1	R20	1-216-853-11	METAL CHIP	470K 5% 1/10W
Q708	8-729-010-25	TRANSISTOR	MSD601-RT1	R22	1-216-821-11	METAL CHIP	1K 5% 1/10W
Q709	8-729-010-25	TRANSISTOR	MSD601-RT1	R23	1-216-857-11	METAL CHIP	1M 5% 1/10W
Q710	8-729-010-25	TRANSISTOR	MSD601-RT1	R24	1-216-847-11	METAL CHIP	150K 5% 1/10W
Q711	8-729-010-05	TRANSISTOR	MSB709-RT1	R25	1-216-825-11	METAL CHIP	2.2K 5% 1/10W
Q712	8-729-010-05	TRANSISTOR	MSB709-RT1	R46	1-216-833-11	METAL CHIP	10K 5% 1/10W
Q714	8-729-010-25	TRANSISTOR	MSD601-RT1	R48	1-216-809-11	METAL CHIP	100 5% 1/10W
Q717	8-729-010-25	TRANSISTOR	MSD601-RT1	R49	1-216-833-11	METAL CHIP	10K 5% 1/10W
Q718	8-729-010-25	TRANSISTOR	MSD601-RT1	R50	1-216-809-11	METAL CHIP	100 5% 1/10W
Q719	8-729-010-25	TRANSISTOR	MSD601-RT1	R52	1-216-845-11	METAL CHIP	100K 5% 1/10W
Q721	8-729-010-25	TRANSISTOR	MSD601-RT1	R54	1-216-809-11	METAL CHIP	100 5% 1/10W
Q722	8-729-029-14	TRANSISTOR	DTC144EUA-T106	R57	1-216-825-11	METAL CHIP	2.2K 5% 1/10W
Q723	8-729-010-25	TRANSISTOR	MSD601-RT1	R58	1-216-824-11	METAL CHIP	1.8K 5% 1/10W
Q730	8-729-010-05	TRANSISTOR	MSB709-RT1	R60	1-216-825-11	METAL CHIP	2.2K 5% 1/10W
Q851	8-729-010-25	TRANSISTOR	MSD601-RT1	R62	1-216-837-11	METAL CHIP	22K 5% 1/10W
Q852	8-729-010-05	TRANSISTOR	MSB709-RT1	R65	1-216-833-11	METAL CHIP	10K 5% 1/10W
Q853	8-729-010-05	TRANSISTOR	MSB709-RT1	R66	1-216-821-11	METAL CHIP	1K 5% 1/10W
Q854	8-729-010-25	TRANSISTOR	MSD601-RT1	R67	1-216-839-11	METAL CHIP	33K 5% 1/10W
Q855	8-729-010-05	TRANSISTOR	MSB709-RT1	R68	1-216-825-11	METAL CHIP	2.2K 5% 1/10W
Q856	8-729-010-25	TRANSISTOR	MSD601-RT1	R69	1-216-824-11	METAL CHIP	1.8K 5% 1/10W
Q857	8-729-010-05	TRANSISTOR	MSB709-RT1	R70	1-216-821-11	METAL CHIP	1K 5% 1/10W
Q858	8-729-010-25	TRANSISTOR	MSD601-RT1	R72	1-216-833-11	METAL CHIP	10K 5% 1/10W
Q859	8-729-028-28	TRANSISTOR	2SK2036(TE85L)	R73	1-216-821-11	METAL CHIP	1K 5% 1/10W
Q860	8-729-028-28	TRANSISTOR	2SK2036(TE85L)	R74	1-216-809-11	METAL CHIP	100 5% 1/10W
				R75	1-216-847-11	METAL CHIP	150K 5% 1/10W
				R77	1-216-857-11	METAL CHIP	1M 5% 1/10W
				R78	1-216-842-11	METAL CHIP	56K 5% 1/10W



REF. NO.	PART NO.	DESCRIPTION	VALUES			REF. NO.	PART NO.	DESCRIPTION	VALUES		
R79	1-216-825-11	METAL CHIP	2.2K	5%	1/10W	R136	1-216-809-11	METAL CHIP	100	5%	1/10W
R81	1-216-829-11	METAL CHIP	4.7K	5%	1/10W	R137	1-216-817-11	METAL CHIP	470	5%	1/10W
R83	1-216-829-11	METAL CHIP	4.7K	5%	1/10W	R138	1-216-809-11	METAL CHIP	100	5%	1/10W
R84	1-216-833-11	METAL CHIP	10K	5%	1/10W	R139	1-216-817-11	METAL CHIP	470	5%	1/10W
R85	1-216-857-11	METAL CHIP	1M	5%	1/10W	R140	1-216-817-11	METAL CHIP	470	5%	1/10W
R89	1-216-864-11	SHORT CHIP				R142	1-216-817-11	METAL CHIP	470	5%	1/10W
R90	1-216-864-11	SHORT CHIP				R143	1-216-821-11	METAL CHIP	1K	5%	1/10W
R91	1-216-833-11	METAL CHIP	10K	5%	1/10W	R144	1-216-817-11	METAL CHIP	470	5%	1/10W
R92	1-216-864-11	SHORT CHIP				R145	1-216-809-11	METAL CHIP	100	5%	1/10W
R93	1-216-821-11	METAL CHIP	1K	5%	1/10W	R146	1-216-817-11	METAL CHIP	470	5%	1/10W
R94	1-216-813-11	METAL CHIP	220	5%	1/10W	R147	1-216-817-11	METAL CHIP	470	5%	1/10W
R95	1-216-819-11	METAL CHIP	680	5%	1/10W	R148	1-216-809-11	METAL CHIP	100	5%	1/10W
R96	1-218-285-11	METAL CHIP	75	5%	1/10W	R149	1-216-817-11	METAL CHIP	470	5%	1/10W
R97	1-216-809-11	METAL CHIP	100	5%	1/10W	R150	1-216-809-11	METAL CHIP	100	5%	1/10W
R100	1-216-809-11	METAL CHIP	100	5%	1/10W	R151	1-216-833-11	METAL CHIP	10K	5%	1/10W
R101	1-218-285-11	METAL CHIP	75	5%	1/10W	R152	1-216-817-11	METAL CHIP	470	5%	1/10W
R102	1-218-285-11	METAL CHIP	75	5%	1/10W	R153	1-216-817-11	METAL CHIP	470	5%	1/10W
R103	1-218-285-11	METAL CHIP	75	5%	1/10W	R154	1-216-817-11	METAL CHIP	470	5%	1/10W
R104	1-218-285-11	METAL CHIP	75	5%	1/10W	R155	1-216-809-11	METAL CHIP	100	5%	1/10W
R105	1-218-285-11	METAL CHIP	75	5%	1/10W	R156	1-216-817-11	METAL CHIP	470	5%	1/10W
R106	1-216-819-11	METAL CHIP	680	5%	1/10W	R157	1-216-809-11	METAL CHIP	100	5%	1/10W
R107	1-216-833-11	METAL CHIP	10K	5%	1/10W	R158	1-216-817-11	METAL CHIP	470	5%	1/10W
R108	1-216-843-11	METAL CHIP	68K	5%	1/10W	R159	1-216-809-11	METAL CHIP	100	5%	1/10W
R109	1-216-806-11	METAL CHIP	56	5%	1/10W	R160	1-216-809-11	METAL CHIP	100	5%	1/10W
R110	1-216-806-11	METAL CHIP	56	5%	1/10W	R161	1-216-809-11	METAL CHIP	100	5%	1/10W
R111	1-216-806-11	METAL CHIP	56	5%	1/10W	R162	1-216-809-11	METAL CHIP	100	5%	1/10W
R112	1-216-813-11	METAL CHIP	220	5%	1/10W	R163	1-216-817-11	METAL CHIP	470	5%	1/10W
R113	1-216-813-11	METAL CHIP	220	5%	1/10W	R164	1-216-817-11	METAL CHIP	470	5%	1/10W
R114	1-216-809-11	METAL CHIP	100	5%	1/10W	R165	1-216-817-11	METAL CHIP	470	5%	1/10W
R115	1-216-809-11	METAL CHIP	100	5%	1/10W	R166	1-216-817-11	METAL CHIP	470	5%	1/10W
R116	1-216-819-11	METAL CHIP	680	5%	1/10W	R167	1-216-817-11	METAL CHIP	470	5%	1/10W
R118	1-216-843-11	METAL CHIP	68K	5%	1/10W	R168	1-216-817-11	METAL CHIP	470	5%	1/10W
R119	1-216-813-11	METAL CHIP	220	5%	1/10W	R169	1-216-817-11	METAL CHIP	470	5%	1/10W
R120	1-216-813-11	METAL CHIP	220	5%	1/10W	R170	1-216-809-11	METAL CHIP	100	5%	1/10W
R121	1-216-809-11	METAL CHIP	100	5%	1/10W	R171	1-216-809-11	METAL CHIP	100	5%	1/10W
R122	1-216-819-11	METAL CHIP	680	5%	1/10W	R172	1-216-809-11	METAL CHIP	100	5%	1/10W
R125	1-216-819-11	METAL CHIP	680	5%	1/10W	R173	1-216-809-11	METAL CHIP	100	5%	1/10W
R126	1-216-809-11	METAL CHIP	100	5%	1/10W	R174	1-216-809-11	METAL CHIP	100	5%	1/10W
R128	1-216-809-11	METAL CHIP	100	5%	1/10W	R175	1-216-809-11	METAL CHIP	100	5%	1/10W
R129	1-216-809-11	METAL CHIP	100	5%	1/10W	R176	1-216-809-11	METAL CHIP	100	5%	1/10W
R131	1-216-809-11	METAL CHIP	100	5%	1/10W	R177	1-216-809-11	METAL CHIP	100	5%	1/10W
R132	1-216-809-11	METAL CHIP	100	5%	1/10W	R180	1-216-861-11	METAL CHIP	2.2M	5%	1/10W
R133	1-216-809-11	METAL CHIP	100	5%	1/10W	R181	1-216-861-11	METAL CHIP	2.2M	5%	1/10W
R135	1-216-809-11	METAL CHIP	100	5%	1/10W	R182	1-216-817-11	METAL CHIP	470	5%	1/10W



REF. NO.	PART NO.	DESCRIPTION	VALUES			REF. NO.	PART NO.	DESCRIPTION	VALUES		
R183	1-216-817-11	METAL CHIP	470	5%	1/10W	R238	1-216-837-11	METAL CHIP	22K	5%	1/10W
R184	1-216-853-11	METAL CHIP	470K	5%	1/10W	R239	1-216-836-11	METAL CHIP	18K	5%	1/10W
R185	1-216-853-11	METAL CHIP	470K	5%	1/10W	R240	1-216-841-11	METAL CHIP	47K	5%	1/10W
R186	1-216-817-11	METAL CHIP	470	5%	1/10W	R241	1-216-841-11	METAL CHIP	47K	5%	1/10W
R187	1-216-817-11	METAL CHIP	470	5%	1/10W	R242	1-216-809-11	METAL CHIP	100	5%	1/10W
R188	1-216-864-11	SHORT CHIP				R243	1-216-821-11	METAL CHIP	1K	5%	1/10W
R189	1-216-864-11	SHORT CHIP				R244	1-216-809-11	METAL CHIP	100	5%	1/10W
R191	1-216-809-11	METAL CHIP	100	5%	1/10W	R245	1-216-821-11	METAL CHIP	1K	5%	1/10W
R197	1-216-825-11	METAL CHIP	2.2K	5%	1/10W	R247	1-216-841-11	METAL CHIP	47K	5%	1/10W
R198	1-216-845-11	METAL CHIP	100K	5%	1/10W	R248	1-216-821-11	METAL CHIP	1K	5%	1/10W
R199	1-216-849-11	METAL CHIP	220K	5%	1/10W	R307	1-216-809-11	METAL CHIP	100	5%	1/10W
R200	1-216-845-11	METAL CHIP	100K	5%	1/10W	R308	1-216-821-11	METAL CHIP	1K	5%	1/10W
R201	1-216-845-11	METAL CHIP	100K	5%	1/10W	R311	1-216-821-11	METAL CHIP	1K	5%	1/10W
R203	1-216-833-11	METAL CHIP	10K	5%	1/10W	R312	1-216-821-11	METAL CHIP	1K	5%	1/10W
R204	1-216-849-11	METAL CHIP	220K	5%	1/10W	R314	1-218-841-11	METAL CHIP	560	0.50%	1/10W
R205	1-216-849-11	METAL CHIP	220K	5%	1/10W	R316	1-216-825-11	METAL CHIP	2.2K	5%	1/10W
R206	1-216-845-11	METAL CHIP	100K	5%	1/10W	R320	1-216-821-11	METAL CHIP	1K	5%	1/10W
R207	1-216-841-11	METAL CHIP	47K	5%	1/10W	R321	1-216-821-11	METAL CHIP	1K	5%	1/10W
R208	1-216-833-11	METAL CHIP	10K	5%	1/10W	R322	1-218-864-11	METAL CHIP	5.1K	0.50%	1/10W
R209	1-216-845-11	METAL CHIP	100K	5%	1/10W	R323	1-218-841-11	METAL CHIP	560	0.50%	1/10W
R210	1-216-864-11	SHORT CHIP				R324	1-216-825-11	METAL CHIP	2.2K	5%	1/10W
R211	1-216-841-11	METAL CHIP	47K	5%	1/10W	R325	1-216-821-11	METAL CHIP	1K	5%	1/10W
R212	1-216-841-11	METAL CHIP	47K	5%	1/10W	R328	1-249-377-11	CARBON	0.47	5%	1/4W
R213	1-216-837-11	METAL CHIP	22K	5%	1/10W	R330	1-218-841-11	METAL CHIP	560	0.50%	1/10W
R214	1-216-836-11	METAL CHIP	18K	5%	1/10W	R331	1-216-821-11	METAL CHIP	1K	5%	1/10W
R215	1-216-809-11	METAL CHIP	100	5%	1/10W	R332	1-218-889-11	METAL CHIP	56K	0.50%	1/10W
R216	1-216-811-11	METAL CHIP	150	5%	1/10W	R335	1-218-847-11	METAL CHIP	1K	0.50%	1/10W
R217	1-216-811-11	METAL CHIP	150	5%	1/10W	R336	1-211-981-11	METAL CHIP	33	0.50%	1/10W
R218	1-216-811-11	METAL CHIP	150	5%	1/10W	R337	1-218-847-11	METAL CHIP	1K	0.50%	1/10W
R219	1-216-809-11	METAL CHIP	100	5%	1/10W	R338	1-211-969-11	METAL CHIP	10	0.50%	1/10W
R220	1-216-809-11	METAL CHIP	100	5%	1/10W	R339	1-218-859-11	METAL CHIP	3.3K	0.50%	1/10W
R222	1-216-853-11	METAL CHIP	470K	5%	1/10W	R340	1-211-977-11	METAL CHIP	22	0.50%	1/10W
R223	1-216-853-11	METAL CHIP	470K	5%	1/10W	R343	1-218-859-11	METAL CHIP	3.3K	0.50%	1/10W
R225	1-216-811-11	METAL CHIP	150	5%	1/10W	R346	1-218-855-11	METAL CHIP	2.2K	0.50%	1/10W
R226	1-216-811-11	METAL CHIP	150	5%	1/10W	R347	1-218-859-11	METAL CHIP	3.3K	0.50%	1/10W
R227	1-216-811-11	METAL CHIP	150	5%	1/10W	R348	1-216-864-11	SHORT CHIP			
R228	1-216-853-11	METAL CHIP	470K	5%	1/10W	R361	1-216-821-11	METAL CHIP	1K	5%	1/10W
R229	1-216-853-11	METAL CHIP	470K	5%	1/10W	R365	1-216-811-11	METAL CHIP	150	5%	1/10W
R230	1-216-811-11	METAL CHIP	150	5%	1/10W	R366	1-216-812-11	METAL CHIP	180	5%	1/10W
R231	1-216-811-11	METAL CHIP	150	5%	1/10W	R367	1-216-839-11	METAL CHIP	33K	5%	1/10W
R232	1-216-811-11	METAL CHIP	150	5%	1/10W	R368	1-216-837-11	METAL CHIP	22K	5%	1/10W
R235	1-216-811-11	METAL CHIP	150	5%	1/10W	R369	1-216-839-11	METAL CHIP	33K	5%	1/10W
R236	1-216-811-11	METAL CHIP	150	5%	1/10W	R370	1-216-837-11	METAL CHIP	22K	5%	1/10W
R237	1-216-811-11	METAL CHIP	150	5%	1/10W	R371	1-216-809-11	METAL CHIP	100	5%	1/10W



REF. NO.	PART NO.	DESCRIPTION	VALUES			REF. NO.	PART NO.	DESCRIPTION	VALUES		
R372	1-216-809-11	METAL CHIP	100	5%	1/10W	R480	1-216-825-11	METAL CHIP	2.2K	5%	1/10W
R373	1-216-817-11	METAL CHIP	470	5%	1/10W	R481	1-216-809-11	METAL CHIP	100	5%	1/10W
R374	1-216-817-11	METAL CHIP	470	5%	1/10W	R482	1-216-809-11	METAL CHIP	100	5%	1/10W
R375	1-218-841-11	METAL CHIP	560	0.50%	1/10W	R483	1-216-821-11	METAL CHIP	1K	5%	1/10W
R376	1-218-841-11	METAL CHIP	560	0.50%	1/10W	R484	1-216-821-11	METAL CHIP	1K	5%	1/10W
R377	1-218-865-11	METAL CHIP	5.6K	0.50%	1/10W	R485	1-216-821-11	METAL CHIP	1K	5%	1/10W
R378	1-218-865-11	METAL CHIP	5.6K	0.50%	1/10W	R486	1-216-809-11	METAL CHIP	100	5%	1/10W
R379	1-216-817-11	METAL CHIP	470	5%	1/10W	R488	1-216-826-11	METAL CHIP	2.7K	5%	1/10W
R380	1-216-817-11	METAL CHIP	470	5%	1/10W	R489	1-216-821-11	METAL CHIP	1K	5%	1/10W
R385	1-216-835-11	METAL CHIP	15K	5%	1/10W	R491	1-216-821-11	METAL CHIP	1K	5%	1/10W
R389	1-216-809-11	METAL CHIP	100	5%	1/10W	R492	1-216-809-11	METAL CHIP	100	5%	1/10W
R390	1-216-809-11	METAL CHIP	100	5%	1/10W	R493	1-216-834-11	METAL CHIP	12K	5%	1/10W
R393	1-216-828-11	METAL CHIP	3.9K	5%	1/10W	R494	1-218-863-11	METAL CHIP	4.7K	0.50%	1/10W
R396	1-216-864-11	SHORT CHIP				R495	1-216-809-11	METAL CHIP	100	5%	1/10W
R397	1-216-864-11	SHORT CHIP				R496	1-216-821-11	METAL CHIP	1K	5%	1/10W
R398	1-216-864-11	SHORT CHIP				R497	1-216-825-11	METAL CHIP	2.2K	5%	1/10W
R399	1-216-809-11	METAL CHIP	100	5%	1/10W	R498	1-216-809-11	METAL CHIP	100	5%	1/10W
R400	1-216-809-11	METAL CHIP	100	5%	1/10W	R499	1-216-829-11	METAL CHIP	4.7K	5%	1/10W
R451	1-216-833-11	METAL CHIP	10K	5%	1/10W	R500	1-216-823-11	METAL CHIP	1.5K	5%	1/10W
R452	1-216-821-11	METAL CHIP	1K	5%	1/10W	R501	1-216-863-11	METAL CHIP	3.3M	5%	1/10W
R453	1-216-833-11	METAL CHIP	10K	5%	1/10W	R502	1-216-809-11	METAL CHIP	100	5%	1/10W
R454	1-216-833-11	METAL CHIP	10K	5%	1/10W	R503	1-216-809-11	METAL CHIP	100	5%	1/10W
R455	1-216-809-11	METAL CHIP	100	5%	1/10W	R504	1-216-809-11	METAL CHIP	100	5%	1/10W
R457	1-216-809-11	METAL CHIP	100	5%	1/10W	R505	1-216-841-11	METAL CHIP	47K	5%	1/10W
R459	1-216-809-11	METAL CHIP	100	5%	1/10W	R506	1-216-841-11	METAL CHIP	47K	5%	1/10W
R460	1-216-809-11	METAL CHIP	100	5%	1/10W	R510	1-216-815-11	METAL CHIP	330	5%	1/10W
R461	1-218-871-11	METAL CHIP	10K	0.50%	1/10W	R511	1-216-827-11	METAL CHIP	3.3K	5%	1/10W
R462	1-218-871-11	METAL CHIP	10K	0.50%	1/10W	R512	1-216-829-11	METAL CHIP	4.7K	5%	1/10W
R463	1-218-871-11	METAL CHIP	10K	0.50%	1/10W	R513	1-216-829-11	METAL CHIP	4.7K	5%	1/10W
R464	1-216-841-11	METAL CHIP	47K	5%	1/10W	R514	1-216-829-11	METAL CHIP	4.7K	5%	1/10W
R465	1-216-841-11	METAL CHIP	47K	5%	1/10W	R515	1-216-825-11	METAL CHIP	2.2K	5%	1/10W
R466	1-218-871-11	METAL CHIP	10K	0.50%	1/10W	R516	1-216-825-11	METAL CHIP	2.2K	5%	1/10W
R467	1-216-809-11	METAL CHIP	100	5%	1/10W	R517	1-216-825-11	METAL CHIP	2.2K	5%	1/10W
R468	1-216-845-11	METAL CHIP	100K	5%	1/10W	R518	1-216-825-11	METAL CHIP	2.2K	5%	1/10W
R469	1-216-832-11	METAL CHIP	8.2K	5%	1/10W	R519	1-216-825-11	METAL CHIP	2.2K	5%	1/10W
R470	1-216-809-11	METAL CHIP	100	5%	1/10W	R520	1-216-829-11	METAL CHIP	4.7K	5%	1/10W
R471	1-216-809-11	METAL CHIP	100	5%	1/10W	R521	1-216-825-11	METAL CHIP	2.2K	5%	1/10W
R472	1-216-853-11	METAL CHIP	470K	5%	1/10W	R522	1-216-825-11	METAL CHIP	2.2K	5%	1/10W
R473	1-216-809-11	METAL CHIP	100	5%	1/10W	R523	1-216-821-11	METAL CHIP	1K	5%	1/10W
R474	1-216-809-11	METAL CHIP	100	5%	1/10W	R524	1-218-871-11	METAL CHIP	10K	0.50%	1/10W
R475	1-216-809-11	METAL CHIP	100	5%	1/10W	R525	1-216-815-11	METAL CHIP	330	5%	1/10W
R476	1-216-818-11	METAL CHIP	560	5%	1/10W	R527	1-216-809-11	METAL CHIP	100	5%	1/10W
R478	1-216-864-11	SHORT CHIP				R528	1-216-825-11	METAL CHIP	2.2K	5%	1/10W
R479	1-216-864-11	SHORT CHIP				R529	1-216-825-11	METAL CHIP	2.2K	5%	1/10W



REF. NO.	PART NO.	DESCRIPTION	VALUES			REF. NO.	PART NO.	DESCRIPTION	VALUES		
R531	1-216-833-11	METAL CHIP	10K	5%	1/10W	R583	1-216-821-11	METAL CHIP	1K	5%	1/10W
R532	1-216-809-11	METAL CHIP	100	5%	1/10W	R584	1-216-821-11	METAL CHIP	1K	5%	1/10W
R533	1-216-825-11	METAL CHIP	2.2K	5%	1/10W	R585	1-216-821-11	METAL CHIP	1K	5%	1/10W
R535	1-216-825-11	METAL CHIP	2.2K	5%	1/10W	R601	1-216-833-11	METAL CHIP	10K	5%	1/10W
R536	1-216-825-11	METAL CHIP	2.2K	5%	1/10W	R602	1-216-833-11	METAL CHIP	10K	5%	1/10W
R537	1-218-875-11	METAL CHIP	15K	0.50%	1/10W	R603	1-216-833-11	METAL CHIP	10K	5%	1/10W
R538	1-216-825-11	METAL CHIP	2.2K	5%	1/10W	R604	1-216-855-11	METAL CHIP	680K	5%	1/10W
R540	1-216-864-11	SHORT CHIP				R605	1-216-835-11	METAL CHIP	15K	5%	1/10W
R541	1-216-825-11	METAL CHIP	2.2K	5%	1/10W	R607	1-216-829-11	METAL CHIP	4.7K	5%	1/10W
R543	1-216-864-11	SHORT CHIP				R608	1-216-864-11	SHORT CHIP			
R544	1-216-815-11	METAL CHIP	330	5%	1/10W	R611	1-249-405-11	CARBON	100	5%	1/4W
R545	1-216-809-11	METAL CHIP	100	5%	1/10W	R614	1-216-840-11	METAL CHIP	39K	5%	1/10W
R546	1-216-825-11	METAL CHIP	2.2K	5%	1/10W	R615	1-216-829-11	METAL CHIP	4.7K	5%	1/10W
R547	1-216-825-11	METAL CHIP	2.2K	5%	1/10W	R616	1-249-405-11	CARBON	100	5%	1/4W
R548	1-216-825-11	METAL CHIP	2.2K	5%	1/10W	R619	1-216-833-11	METAL CHIP	10K	5%	1/10W
R549	1-216-825-11	METAL CHIP	2.2K	5%	1/10W	R620	1-216-829-11	METAL CHIP	4.7K	5%	1/10W
R550	1-216-825-11	METAL CHIP	2.2K	5%	1/10W	R621	1-218-871-11	METAL CHIP	10K	0.50%	1/10W
R551	1-216-825-11	METAL CHIP	2.2K	5%	1/10W	R622	1-216-829-11	METAL CHIP	4.7K	5%	1/10W
R552	1-216-825-11	METAL CHIP	2.2K	5%	1/10W	R623	1-216-841-11	METAL CHIP	47K	5%	1/10W
R553	1-216-825-11	METAL CHIP	2.2K	5%	1/10W	R624	1-216-817-11	METAL CHIP	470	5%	1/10W
R554	1-216-825-11	METAL CHIP	2.2K	5%	1/10W	R625	1-216-839-11	METAL CHIP	33K	5%	1/10W
R555	1-216-825-11	METAL CHIP	2.2K	5%	1/10W	R628	1-216-843-11	METAL CHIP	68K	5%	1/10W
R556	1-216-825-11	METAL CHIP	2.2K	5%	1/10W	R629	1-218-879-11	METAL CHIP	22K	0.50%	1/10W
R557	1-216-825-11	METAL CHIP	2.2K	5%	1/10W	R631	1-216-864-11	SHORT CHIP			
R558	1-216-825-11	METAL CHIP	2.2K	5%	1/10W	R633	1-218-879-11	METAL CHIP	22K	0.50%	1/10W
R559	1-216-864-11	SHORT CHIP				R634	1-216-833-11	METAL CHIP	10K	5%	1/10W
R560	1-216-809-11	METAL CHIP	100	5%	1/10W	R636	1-216-843-11	METAL CHIP	68K	5%	1/10W
R562	1-216-805-11	METAL CHIP	47	5%	1/10W	R637	1-216-846-11	METAL CHIP	120K	5%	1/10W
R564	1-216-803-11	METAL CHIP	33	5%	1/10W	R638	1-216-817-11	METAL CHIP	470	5%	1/10W
R565	1-216-803-11	METAL CHIP	33	5%	1/10W	R639	1-216-839-11	METAL CHIP	33K	5%	1/10W
R566	1-216-803-11	METAL CHIP	33	5%	1/10W	R641	1-216-864-11	SHORT CHIP			
R567	1-216-804-11	METAL CHIP	39	5%	1/10W	R642	1-216-829-11	METAL CHIP	4.7K	5%	1/10W
R568	1-216-804-11	METAL CHIP	39	5%	1/10W	R643	1-216-833-11	METAL CHIP	10K	5%	1/10W
R569	1-216-804-11	METAL CHIP	39	5%	1/10W	R644	1-216-841-11	METAL CHIP	47K	5%	1/10W
R572	1-216-809-11	METAL CHIP	100	5%	1/10W	R645	1-216-840-11	METAL CHIP	39K	5%	1/10W
R573	1-216-809-11	METAL CHIP	100	5%	1/10W	R646	1-249-405-11	CARBON	100	5%	1/4W
R574	1-216-809-11	METAL CHIP	100	5%	1/10W	R649	1-249-405-11	CARBON	100	5%	1/4W
R575	1-216-864-11	SHORT CHIP				R652	1-216-795-11	METAL CHIP	6.8	5%	1/10W
R576	1-216-817-11	METAL CHIP	470	5%	1/10W	R653	1-216-842-11	METAL CHIP	56K	5%	1/10W
R577	1-216-819-11	METAL CHIP	680	5%	1/10W	R654	1-216-829-11	METAL CHIP	4.7K	5%	1/10W
R578	1-218-285-11	METAL CHIP	75	5%	1/10W	R655	1-216-829-11	METAL CHIP	4.7K	5%	1/10W
R579	1-218-285-11	METAL CHIP	75	5%	1/10W	R656	1-216-842-11	METAL CHIP	56K	5%	1/10W
R580	1-218-285-11	METAL CHIP	75	5%	1/10W	R657	1-218-871-11	METAL CHIP	10K	0.50%	1/10W
R581	1-216-809-11	METAL CHIP	100	5%	1/10W	R658	1-218-870-11	METAL CHIP	9.1K	0.50%	1/10W



REF. NO.	PART NO.	DESCRIPTION	VALUES			REF. NO.	PART NO.	DESCRIPTION	VALUES		
R659	1-216-809-11	METAL CHIP	100	5%	1/10W	R735	1-216-809-11	METAL CHIP	100	5%	1/10W
R660	1-218-871-11	METAL CHIP	10K	0.50%	1/10W	R737	1-216-816-11	METAL CHIP	390	5%	1/10W
R661	1-216-835-11	METAL CHIP	15K	5%	1/10W	R738	1-216-809-11	METAL CHIP	100	5%	1/10W
R662	1-216-821-11	METAL CHIP	1K	5%	1/10W	R740	1-216-809-11	METAL CHIP	100	5%	1/10W
R663	1-216-821-11	METAL CHIP	1K	5%	1/10W	R741	1-216-809-11	METAL CHIP	100	5%	1/10W
R664	1-216-841-11	METAL CHIP	47K	5%	1/10W	R742	1-216-864-11	SHORT CHIP			
R665	1-216-833-11	METAL CHIP	10K	5%	1/10W	R744	1-216-809-11	METAL CHIP	100	5%	1/10W
R666	1-216-829-11	METAL CHIP	4.7K	5%	1/10W	R745	1-216-809-11	METAL CHIP	100	5%	1/10W
R667	1-215-880-00	METAL OXIDE	10	5%	2W	R746	1-216-809-11	METAL CHIP	100	5%	1/10W
R668	1-215-880-00	METAL OXIDE	10	5%	2W	R747	1-216-809-11	METAL CHIP	100	5%	1/10W
R701	1-216-821-11	METAL CHIP	1K	5%	1/10W	R748	1-216-833-11	METAL CHIP	10K	5%	1/10W
R702	1-216-821-11	METAL CHIP	1K	5%	1/10W	R749	1-216-833-11	METAL CHIP	10K	5%	1/10W
R703	1-216-809-11	METAL CHIP	100	5%	1/10W	R750	1-216-833-11	METAL CHIP	10K	5%	1/10W
R704	1-216-809-11	METAL CHIP	100	5%	1/10W	R751	1-216-809-11	METAL CHIP	100	5%	1/10W
R705	1-216-821-11	METAL CHIP	1K	5%	1/10W	R752	1-216-809-11	METAL CHIP	100	5%	1/10W
R706	1-216-829-11	METAL CHIP	4.7K	5%	1/10W	R754	1-216-833-11	METAL CHIP	10K	5%	1/10W
R707	1-216-821-11	METAL CHIP	1K	5%	1/10W	R755	1-216-833-11	METAL CHIP	10K	5%	1/10W
R708	1-216-857-11	METAL CHIP	1M	5%	1/10W	R756	1-216-833-11	METAL CHIP	10K	5%	1/10W
R709	1-216-817-11	METAL CHIP	470	5%	1/10W	R757	1-216-833-11	METAL CHIP	10K	5%	1/10W
R710	1-216-857-11	METAL CHIP	1M	5%	1/10W	R758	1-216-845-11	METAL CHIP	100K	5%	1/10W
R711	1-216-829-11	METAL CHIP	4.7K	5%	1/10W	R759	1-216-833-11	METAL CHIP	10K	5%	1/10W
R712	1-216-817-11	METAL CHIP	470	5%	1/10W	R760	1-216-809-11	METAL CHIP	100	5%	1/10W
R713	1-216-833-11	METAL CHIP	10K	5%	1/10W	R761	1-216-841-11	METAL CHIP	47K	5%	1/10W
R714	1-216-821-11	METAL CHIP	1K	5%	1/10W	R762	1-216-809-11	METAL CHIP	100	5%	1/10W
R715	1-216-809-11	METAL CHIP	100	5%	1/10W	R763	1-216-805-11	METAL CHIP	47	5%	1/10W
R716	1-216-809-11	METAL CHIP	100	5%	1/10W	R764	1-216-833-11	METAL CHIP	10K	5%	1/10W
R717	1-216-809-11	METAL CHIP	100	5%	1/10W	R765	1-216-805-11	METAL CHIP	47	5%	1/10W
R718	1-216-809-11	METAL CHIP	100	5%	1/10W	R766	1-216-821-11	METAL CHIP	1K	5%	1/10W
R719	1-216-833-11	METAL CHIP	10K	5%	1/10W	R767	1-216-864-11	SHORT CHIP			
R720	1-216-809-11	METAL CHIP	100	5%	1/10W	R768	1-216-816-11	METAL CHIP	390	5%	1/10W
R721	1-216-809-11	METAL CHIP	100	5%	1/10W	R769	1-216-841-11	METAL CHIP	47K	5%	1/10W
R722	1-216-809-11	METAL CHIP	100	5%	1/10W	R770	1-216-833-11	METAL CHIP	10K	5%	1/10W
R723	1-216-809-11	METAL CHIP	100	5%	1/10W	R771	1-216-864-11	SHORT CHIP			
R724	1-216-809-11	METAL CHIP	100	5%	1/10W	R772	1-216-816-11	METAL CHIP	390	5%	1/10W
R725	1-216-841-11	METAL CHIP	47K	5%	1/10W	R773	1-216-809-11	METAL CHIP	100	5%	1/10W
R726	1-216-829-11	METAL CHIP	4.7K	5%	1/10W	R774	1-216-809-11	METAL CHIP	100	5%	1/10W
R727	1-216-821-11	METAL CHIP	1K	5%	1/10W	R775	1-216-809-11	METAL CHIP	100	5%	1/10W
R728	1-216-833-11	METAL CHIP	10K	5%	1/10W	R776	1-216-809-11	METAL CHIP	100	5%	1/10W
R729	1-216-841-11	METAL CHIP	47K	5%	1/10W	R777	1-216-809-11	METAL CHIP	100	5%	1/10W
R730	1-216-809-11	METAL CHIP	100	5%	1/10W	R778	1-216-864-11	SHORT CHIP			
R731	1-216-809-11	METAL CHIP	100	5%	1/10W	R779	1-216-837-11	METAL CHIP	22K	5%	1/10W
R732	1-216-809-11	METAL CHIP	100	5%	1/10W	R780	1-216-816-11	METAL CHIP	390	5%	1/10W
R733	1-216-813-11	METAL CHIP	220	5%	1/10W	R781	1-216-839-11	METAL CHIP	33K	5%	1/10W
R734	1-216-809-11	METAL CHIP	100	5%	1/10W	R782	1-216-833-11	METAL CHIP	10K	5%	1/10W



REF. NO.	PART NO.	DESCRIPTION	VALUES			REF. NO.	PART NO.	DESCRIPTION	VALUES		
R783	1-216-833-11	METAL CHIP	10K	5%	1/10W	R851	1-216-821-11	METAL CHIP	1K	5%	1/10W
R784	1-216-833-11	METAL CHIP	10K	5%	1/10W	R852	1-218-863-11	METAL CHIP	4.7K	0.50%	1/10W
R785	1-216-841-11	METAL CHIP	47K	5%	1/10W	R853	1-218-706-11	METAL CHIP	3.9K	0.50%	1/10W
R786	1-216-841-11	METAL CHIP	47K	5%	1/10W	R854	1-218-858-11	METAL CHIP	3K	0.50%	1/10W
R787	1-216-864-11	SHORT CHIP				R855	1-218-871-11	METAL CHIP	10K	0.50%	1/10W
R788	1-216-821-11	METAL CHIP	1K	5%	1/10W	R856	1-218-887-11	METAL CHIP	47K	0.50%	1/10W
R789	1-216-829-11	METAL CHIP	4.7K	5%	1/10W	R857	1-218-887-11	METAL CHIP	47K	0.50%	1/10W
R790	1-216-821-11	METAL CHIP	1K	5%	1/10W	R858	1-216-837-11	METAL CHIP	22K	5%	1/10W
R792	1-216-833-11	METAL CHIP	10K	5%	1/10W	R859	1-216-833-11	METAL CHIP	10K	5%	1/10W
R793	1-216-833-11	METAL CHIP	10K	5%	1/10W	R860	1-218-887-11	METAL CHIP	47K	0.50%	1/10W
R797	1-216-821-11	METAL CHIP	1K	5%	1/10W	R861	1-218-841-11	METAL CHIP	560	0.50%	1/10W
R798	1-216-829-11	METAL CHIP	4.7K	5%	1/10W	R862	1-218-887-11	METAL CHIP	47K	0.50%	1/10W
R799	1-216-833-11	METAL CHIP	10K	5%	1/10W	R863	1-218-859-11	METAL CHIP	3.3K	0.50%	1/10W
R800	1-216-809-11	METAL CHIP	100	5%	1/10W	R864	1-218-875-11	METAL CHIP	15K	0.50%	1/10W
R801	1-216-833-11	METAL CHIP	10K	5%	1/10W	R865	1-218-887-11	METAL CHIP	47K	0.50%	1/10W
R802	1-216-864-11	SHORT CHIP				R866	1-218-887-11	METAL CHIP	47K	0.50%	1/10W
R804	1-216-809-11	METAL CHIP	100	5%	1/10W	R867	1-218-861-11	METAL CHIP	3.9K	0.50%	1/10W
R807	1-216-809-11	METAL CHIP	100	5%	1/10W	R868	1-218-887-11	METAL CHIP	47K	0.50%	1/10W
R809	1-216-833-11	METAL CHIP	10K	5%	1/10W	R869	1-218-841-11	METAL CHIP	560	0.50%	1/10W
R810	1-216-825-11	METAL CHIP	2.2K	5%	1/10W	R870	1-218-887-11	METAL CHIP	47K	0.50%	1/10W
R811	1-211-990-11	METAL CHIP	75	0.50%	1/10W	R871	1-218-895-11	METAL CHIP	100K	0.50%	1/10W
R812	1-216-809-11	METAL CHIP	100	5%	1/10W	R872	1-218-877-11	METAL CHIP	18K	0.50%	1/10W
R814	1-216-809-11	METAL CHIP	100	5%	1/10W	R873	1-216-821-11	METAL CHIP	1K	5%	1/10W
R815	1-216-821-11	METAL CHIP	1K	5%	1/10W	R874	1-216-821-11	METAL CHIP	1K	5%	1/10W
R816	1-216-833-11	METAL CHIP	10K	5%	1/10W	R875	1-216-821-11	METAL CHIP	1K	5%	1/10W
R817	1-216-809-11	METAL CHIP	100	5%	1/10W	R876	1-216-821-11	METAL CHIP	1K	5%	1/10W
R818	1-216-833-11	METAL CHIP	10K	5%	1/10W	R877	1-216-821-11	METAL CHIP	1K	5%	1/10W
R819	1-216-825-11	METAL CHIP	2.2K	5%	1/10W	R878	1-216-809-11	METAL CHIP	100	5%	1/10W
R820	1-216-833-11	METAL CHIP	10K	5%	1/10W	R879	1-216-809-11	METAL CHIP	100	5%	1/10W
R821	1-216-841-11	METAL CHIP	47K	5%	1/10W	R880	1-216-841-11	METAL CHIP	47K	5%	1/10W
R822	1-216-809-11	METAL CHIP	100	5%	1/10W	R881	1-216-809-11	METAL CHIP	100	5%	1/10W
R823	1-216-809-11	METAL CHIP	100	5%	1/10W	R882	1-216-823-11	METAL CHIP	1.5K	5%	1/10W
R824	1-216-833-11	METAL CHIP	10K	5%	1/10W	R883	1-216-823-11	METAL CHIP	1.5K	5%	1/10W
R829	1-216-833-11	METAL CHIP	10K	5%	1/10W	R884	1-216-821-11	METAL CHIP	1K	5%	1/10W
R831	1-216-833-11	METAL CHIP	10K	5%	1/10W	R885	1-216-821-11	METAL CHIP	1K	5%	1/10W
R832	1-216-829-11	METAL CHIP	4.7K	5%	1/10W	R886	1-216-809-11	METAL CHIP	100	5%	1/10W
R833	1-216-829-11	METAL CHIP	4.7K	5%	1/10W	R887	1-216-809-11	METAL CHIP	100	5%	1/10W
R834	1-216-833-11	METAL CHIP	10K	5%	1/10W	R888	1-216-821-11	METAL CHIP	1K	5%	1/10W
R835	1-216-833-11	METAL CHIP	10K	5%	1/10W	R889	1-216-825-11	METAL CHIP	2.2K	5%	1/10W
R836	1-216-841-11	METAL CHIP	47K	5%	1/10W	R890	1-216-833-11	METAL CHIP	10K	5%	1/10W
R837	1-216-833-11	METAL CHIP	10K	5%	1/10W	R891	1-216-825-11	METAL CHIP	2.2K	5%	1/10W
R838	1-216-829-11	METAL CHIP	4.7K	5%	1/10W	R892	1-216-818-11	METAL CHIP	560	5%	1/10W
R839	1-216-833-11	METAL CHIP	10K	5%	1/10W	R893	1-216-825-11	METAL CHIP	2.2K	5%	1/10W
R840	1-216-809-11	METAL CHIP	100	5%	1/10W	R894	1-216-818-11	METAL CHIP	560	5%	1/10W





REF. NO.	PART NO.	DESCRIPTION	VALUES			REF. NO.	PART NO.	DESCRIPTION	VALUES		
R895	1-216-833-11	METAL CHIP	10K	5%	1/10W	R939	1-218-883-11	METAL CHIP	33K	0.50%	1/10W
R896	1-216-825-11	METAL CHIP	2.2K	5%	1/10W	R940	1-218-886-11	METAL CHIP	43K	0.50%	1/10W
R897	1-216-818-11	METAL CHIP	560	5%	1/10W	R941	1-218-868-11	METAL CHIP	7.5K	0.50%	1/10W
R898	1-216-833-11	METAL CHIP	10K	5%	1/10W	R942	1-218-871-11	METAL CHIP	10K	0.50%	1/10W
R899	1-218-855-11	METAL CHIP	2.2K	0.50%	1/10W	R943	1-218-868-11	METAL CHIP	7.5K	0.50%	1/10W
R900	1-218-847-11	METAL CHIP	1K	0.50%	1/10W	R944	1-218-868-11	METAL CHIP	7.5K	0.50%	1/10W
R901	1-216-821-11	METAL CHIP	1K	5%	1/10W	R945	1-218-871-11	METAL CHIP	10K	0.50%	1/10W
R902	1-216-809-11	METAL CHIP	100	5%	1/10W	R946	1-218-883-11	METAL CHIP	33K	0.50%	1/10W
R903	1-216-809-11	METAL CHIP	100	5%	1/10W	R947	1-218-883-11	METAL CHIP	33K	0.50%	1/10W
R904	1-216-821-11	METAL CHIP	1K	5%	1/10W	R948	1-218-883-11	METAL CHIP	33K	0.50%	1/10W
R905	1-216-821-11	METAL CHIP	1K	5%	1/10W	R949	1-218-873-11	METAL CHIP	12K	0.50%	1/10W
R906	1-216-829-11	METAL CHIP	4.7K	5%	1/10W	R950	1-218-871-11	METAL CHIP	10K	0.50%	1/10W
R907	1-216-809-11	METAL CHIP	100	5%	1/10W	R951	1-218-871-11	METAL CHIP	10K	0.50%	1/10W
R908	1-216-817-11	METAL CHIP	470	5%	1/10W	R952	1-218-871-11	METAL CHIP	10K	0.50%	1/10W
R909	1-216-821-11	METAL CHIP	1K	5%	1/10W	R955	1-218-863-11	METAL CHIP	4.7K	0.50%	1/10W
R910	1-216-817-11	METAL CHIP	470	5%	1/10W	R956	1-218-863-11	METAL CHIP	4.7K	0.50%	1/10W
R911	1-216-821-11	METAL CHIP	1K	5%	1/10W	R957	1-218-863-11	METAL CHIP	4.7K	0.50%	1/10W
R912	1-216-833-11	METAL CHIP	10K	5%	1/10W	R958	1-216-833-11	METAL CHIP	10K	5%	1/10W
R913	1-216-821-11	METAL CHIP	1K	5%	1/10W	R959	1-216-833-11	METAL CHIP	10K	5%	1/10W
R914	1-216-820-11	METAL CHIP	820	5%	1/10W	R960	1-216-797-11	METAL CHIP	10	5%	1/10W
R915	1-216-821-11	METAL CHIP	1K	5%	1/10W	R961	1-216-797-11	METAL CHIP	10	5%	1/10W
R916	1-216-833-11	METAL CHIP	10K	5%	1/10W						
R917	1-216-821-11	METAL CHIP	1K	5%	1/10W			<u>RESISTOR BRIDGE</u>			
R918	1-216-821-11	METAL CHIP	1K	5%	1/10W	RB1	1-233-576-11	RES, CHIP NETWORK 100	(3216)		
R919	1-216-821-11	METAL CHIP	1K	5%	1/10W						
R920	1-216-821-11	METAL CHIP	1K	5%	1/10W			<u>TUNER</u>			
R921	1-218-863-11	METAL CHIP	4.7K	0.50%	1/10W	TU2	8-598-594-10	TUNER, FSS BTF-FA421			
R922	1-218-863-11	METAL CHIP	4.7K	0.50%	1/10W						
R923	1-218-863-11	METAL CHIP	4.7K	0.50%	1/10W			<u>VARISTOR</u>			
R924	1-218-877-11	METAL CHIP	18K	0.50%	1/10W	VD461	1-804-499-21	VARISTOR, CHIP	(1608)		
R925	1-218-877-11	METAL CHIP	18K	0.50%	1/10W	VD851	1-804-499-21	VARISTOR, CHIP	(1608)		
R926	1-218-877-11	METAL CHIP	18K	0.50%	1/10W	VD852	1-804-499-21	VARISTOR, CHIP	(1608)		
R927	1-218-860-11	METAL CHIP	3.6K	0.50%	1/10W	VD853	1-804-499-21	VARISTOR, CHIP	(1608)		
R928	1-218-877-11	METAL CHIP	18K	0.50%	1/10W	VD854	1-804-499-21	VARISTOR, CHIP	(1608)		
R929	1-218-860-11	METAL CHIP	3.6K	0.50%	1/10W			<u>CRYSTAL</u>			
R930	1-218-877-11	METAL CHIP	18K	0.50%	1/10W	X1	1-781-282-11	VIBRATOR, CERAMIC			
R931	1-218-860-11	METAL CHIP	3.6K	0.50%	1/10W	X301	1-781-131-31	VIBRATOR, CRYSTAL			
R932	1-218-877-11	METAL CHIP	18K	0.50%	1/10W	X451	1-760-895-21	VIBRATOR, CERAMIC			
R933	1-243-692-71	METAL OXIDE	220	5%	1W	X701	1-767-686-21	VIBRATOR, CRYSTAL			
R934	1-216-833-11	METAL CHIP	10K	5%	1/10W	X702	1-781-589-21	VIBRATOR, CRYSTAL			
R935	1-218-871-11	METAL CHIP	10K	0.50%	1/10W	X851	1-795-954-21	PIEZOELECTRIC OSCILLATOR			
R936	1-216-833-11	METAL CHIP	10K	5%	1/10W						
R937	1-216-833-11	METAL CHIP	10K	5%	1/10W						
R938	1-218-882-11	METAL CHIP	30K	0.50%	1/10W						



NOTE: The components identified by shading and  mark are critical for safety. Replace only with part number specified.

NOTE: Les composants identifiés par un trame et une  sont critiques pour la sécurité. Ne les remplacer que par une pièce portant le numéro spécifique.



REF. NO.	PART NO.	DESCRIPTION	VALUES	REF. NO.	PART NO.	DESCRIPTION	VALUES
							
	A-1065-548-A	D BOARD, COMPLETE		C5210	1-162-968-11	CERAMIC CHIP	0.0047µF 10% 50V
	4-382-854-01	SCREW (M3X8), P, SW (+)		C5211	1-107-826-11	CERAMIC CHIP	0.1µF 10% 16V
	7-682-952-09	SCREW +PSW 3X16		C5212	1-126-965-91	ELECT	22µF 20% 50V
				C5213	1-126-965-91	ELECT	22µF 20% 50V
				C5223	1-107-826-11	CERAMIC CHIP	0.1µF 10% 16V
				C5228	1-100-613-81	CERAMIC	470pF 5% 1KV
				C5410	1-104-987-11	MYLAR	0.001µF 5% 200V
				C5418	1-117-813-11	FILM	0.75µF 5% 250V
				C5419	1-107-649-11	ELECT	2.2µF 20% 250V
				C5552	1-126-964-11	ELECT	10µF 20% 50V
				C5553	1-107-698-11	ELECT	10µF 20% 25V
				C5555	1-109-879-11	CERAMIC	22pF 5% 2KV
				C5556	1-109-879-11	CERAMIC	22pF 5% 2KV
				C5557	1-117-214-11	CERAMIC	0.001µF 10% 2KV
				C5703	1-100-566-91	CERAMIC CHIP	0.1µF 10% 25V
				C6400	1-162-964-11	CERAMIC CHIP	0.001µF 10% 50V
				C6401	1-126-964-11	ELECT	10µF 20% 50V
				C6402	1-126-963-11	ELECT	4.7µF 20% 50V
				C6403	1-126-968-11	ELECT	100µF 20% 50V
				C6405	1-162-970-11	CERAMIC CHIP	0.01µF 10% 25V
				C6406	1-136-479-11	FILM	0.001µF 5% 100V
				C6407	1-136-497-81	FILM	0.1µF 5% 50V
				C6409	1-126-947-11	ELECT	47µF 20% 35V
				C6411	1-100-613-81	CERAMIC	470pF 5% 1KV
				C6412	1-100-613-81	CERAMIC	470pF 5% 1KV
				C6413	1-165-954-11	FILM	56000pF 3% 800V
				C6414	1-117-228-71	MYLAR	2.2µF 10% 450V
				C6416	1-126-948-11	ELECT	100µF 20% 35V
				C6417	1-162-974-11	CERAMIC CHIP	0.01µF 50V
				C6418	1-162-970-11	CERAMIC CHIP	0.01µF 10% 25V
				C6419	1-126-941-11	ELECT	470µF 20% 25V
				C6420	1-126-941-11	ELECT	470µF 20% 25V
				C6500	1-126-952-11	ELECT	1000µF 20% 35V
				C6501	1-126-952-11	ELECT	1000µF 20% 35V
				C6503	1-131-970-11	ELECT	1500µF 20% 25V
				C6504	1-131-970-11	ELECT	1500µF 20% 25V
				C6505	1-131-970-11	ELECT	1500µF 20% 25V
				C6506	1-126-941-11	ELECT	470µF 20% 25V
				C6509	1-162-964-11	CERAMIC CHIP	0.001µF 10% 50V
				C6512	1-165-441-81	ELECT	33µF 20% 160V
				C6514	1-107-662-11	ELECT	22µF 20% 350V
				C6515	1-165-733-31	ELECT	100µF 20% 25V
				C6517	1-126-933-11	ELECT	100µF 20% 16V
				C6519	1-107-826-11	CERAMIC CHIP	0.1µF 10% 16V
	C5022	1-117-640-11	FILM	6800pF	3%	1.2KV	
	C5103	1-126-934-11	ELECT	220µF	20%	16V	
	C5104	1-126-941-11	ELECT	470µF	20%	25V	
	C5105	1-164-227-11	CERAMIC CHIP	0.022µF	10%	25V	
	C5106	1-164-227-11	CERAMIC CHIP	0.022µF	10%	25V	
	C5107	1-130-783-71	MYLAR	0.33µF	10%	100V	
	C5108	1-126-968-11	ELECT	100µF	20%	50V	
	C5109	1-126-941-11	ELECT	470µF	20%	25V	
	C5110	1-104-987-11	MYLAR	0.001µF	5%	200V	
	C5111	1-162-964-11	CERAMIC CHIP	0.001µF	10%	50V	
	C5121	1-126-960-11	ELECT	1µF	20%	50V	
	C5201	1-137-150-51	FILM	0.01µF	5%	100V	
	C5202	1-162-970-11	CERAMIC CHIP	0.01µF	10%	25V	
	C5203	1-126-933-11	ELECT	100µF	20%	16V	
	C5204	1-107-648-91	ELECT	100µF	20%	200V	
	C5205	1-115-416-11	CERAMIC CHIP	0.001µF	5%	25V	
	C5206	1-106-383-00	MYLAR	0.047µF	5%	200V	
	C5207	1-104-665-11	ELECT	100µF	20%	25V	
	C5208	1-162-970-11	CERAMIC CHIP	0.01µF	10%	25V	
	C5209	1-162-924-11	CERAMIC CHIP	56pF	5%	50V	

The high-voltage leads associated with the FBT on the D board are not included and must be ordered separately. Order the following leads when requesting this D Board:

-  1-779-095-51 LEAD ASSY, HIGH-VOLTAGE
-  1-900-260-40 CONNECTOR ASSY, MV

CAPACITOR



REF. NO.	PART NO.	DESCRIPTION	VALUES	REF. NO.	PART NO.	DESCRIPTION	VALUES
C6601	1-104-666-11	ELECT	220µF 20% 25V	C8073	1-164-315-11	CERAMIC CHIP	470pF 5% 50V
C6602	1-100-566-91	CERAMIC CHIP	0.1µF 10% 25V	C8074	1-162-970-11	CERAMIC CHIP	0.01µF 10% 25V
C6603	1-162-969-11	CERAMIC CHIP	0.0068µF 10% 25V	C8075	1-162-970-11	CERAMIC CHIP	0.01µF 10% 25V
C6604	1-126-935-11	ELECT	470µF 20% 16V	C8076	1-126-963-11	ELECT	4.7µF 20% 50V
C6615	1-115-349-51	CERAMIC	0.01µF 2KV	C8077	1-162-970-11	CERAMIC CHIP	0.01µF 10% 25V
C6700	1-164-227-11	CERAMIC CHIP	0.022µF 10% 25V	C8078	1-126-964-11	ELECT	10µF 20% 50V
C6707	1-104-987-11	MYLAR	0.001µF 5% 200V	C8139	1-162-966-11	CERAMIC CHIP	0.0022µF 10% 50V
C6803	1-126-235-11	ELECT	100µF 20% 16V	C9401	1-162-927-11	CERAMIC CHIP	100pF 5% 50V
C6804	1-126-964-11	ELECT	10µF 20% 50V	C9402	1-162-927-11	CERAMIC CHIP	100pF 5% 50V
C8001	1-126-964-11	ELECT	10µF 20% 50V	C9403	1-162-927-11	CERAMIC CHIP	100pF 5% 50V
C8002	1-126-964-11	ELECT	10µF 20% 50V	C9404	1-126-968-11	ELECT	100µF 20% 50V
C8003	1-162-970-11	CERAMIC CHIP	0.01µF 10% 25V	C9405	1-162-927-11	CERAMIC CHIP	100pF 5% 50V
C8006	1-126-960-11	ELECT	1µF 20% 50V	C9406	1-162-927-11	CERAMIC CHIP	100pF 5% 50V
C8007	1-162-964-11	CERAMIC CHIP	0.001µF 10% 50V	C9407	1-126-968-11	ELECT	100µF 20% 50V
C8008	1-163-021-91	CERAMIC CHIP	0.01µF 10% 50V	C9408	1-162-927-11	CERAMIC CHIP	100pF 5% 50V
C8012	1-126-947-11	ELECT	47µF 20% 35V	C9409	1-126-968-11	ELECT	100µF 20% 50V
C8015	1-126-947-11	ELECT	47µF 20% 35V	C9410	1-126-968-11	ELECT	100µF 20% 50V
C8016	1-100-566-91	CERAMIC CHIP	0.1µF 10% 25V	C9411	1-162-927-11	CERAMIC CHIP	100pF 5% 50V
C8017	1-126-964-11	ELECT	10µF 20% 50V	C9413	1-162-927-11	CERAMIC CHIP	100pF 5% 50V
C8018	1-126-964-11	ELECT	10µF 20% 50V	C9415	1-165-740-21	ELECT	150µF 20% 35V
C8020	1-136-497-81	FILM	0.1µF 5% 50V	C9416	1-165-740-21	ELECT	150µF 20% 35V
C8021	1-162-968-11	CERAMIC CHIP	0.0047µF 10% 50V	C9417	1-165-740-21	ELECT	150µF 20% 35V
C8022	1-100-385-91	CERAMIC CHIP	0.47µF 25V	C9418	1-162-927-11	CERAMIC CHIP	100pF 5% 50V
C8024	1-126-947-11	ELECT	47µF 20% 35V	C9419	1-162-927-11	CERAMIC CHIP	100pF 5% 50V
C8025	1-126-947-11	ELECT	47µF 20% 35V	C9420	1-165-740-21	ELECT	150µF 20% 35V
C8027	1-136-497-81	FILM	0.1µF 5% 50V	C9423	1-162-927-11	CERAMIC CHIP	100pF 5% 50V
C8028	1-162-966-11	CERAMIC CHIP	0.0022µF 10% 50V	C9425	1-162-927-11	CERAMIC CHIP	100pF 5% 50V
C8030	1-162-970-11	CERAMIC CHIP	0.01µF 10% 25V				
C8031	1-126-933-11	ELECT	100µF 20% 16V	CONNECTOR			
C8032	1-117-160-51	FILM	680pF 2.00% 100V	* CN5003	1-564-509-11	PLUG, CONNECTOR	6P
C8033	1-126-964-11	ELECT	10µF 20% 50V	* CN5004	1-779-890-11	CONNECTOR, BOARD TO BOARD	10P
C8035	1-100-614-81	CERAMIC	330pF 5% 1KV	* CN5005	1-779-890-11	CONNECTOR, BOARD TO BOARD	10P
C8036	1-100-614-81	CERAMIC	330pF 5% 1KV	* CN5006	1-779-890-11	CONNECTOR, BOARD TO BOARD	10P
C8037	1-165-954-11	FILM	56000pF 3% 800V	* CN5009	1-580-689-11	PIN, CONNECTOR (PC BOARD)	4P
C8038	1-162-970-11	CERAMIC CHIP	0.01µF 10% 25V	* CN5010	1-580-689-11	PIN, CONNECTOR (PC BOARD)	4P
C8040	1-104-666-11	ELECT	220µF 20% 25V	* CN5011	1-580-689-11	PIN, CONNECTOR (PC BOARD)	4P
C8041	1-136-497-81	FILM	0.1µF 5% 50V	* CN5013	1-564-506-11	PLUG, CONNECTOR	3P
C8042	1-136-189-00	MYLAR	0.1µF 10% 250V	* CN5014	1-564-506-11	PLUG, CONNECTOR	3P
C8045	1-162-964-11	CERAMIC CHIP	0.001µF 10% 50V	* CN5015	1-564-506-11	PLUG, CONNECTOR	3P
C8046	1-162-968-11	CERAMIC CHIP	0.0047µF 10% 50V	* CN5016	1-779-890-11	CONNECTOR, BOARD TO BOARD	10P
C8048	1-100-566-91	CERAMIC CHIP	0.1µF 10% 25V	* CN5017	1-779-890-11	CONNECTOR, BOARD TO BOARD	10P
C8063	1-135-945-22	FILM	10000pF 3% 800V	* CN5019	1-564-506-11	PLUG, CONNECTOR	3P
C8065	1-127-715-91	CERAMIC CHIP	0.22µF 10% 16V	CN5500	1-764-101-11	PIN, CONNECTOR (PC BOARD)	2P
C8070	1-126-964-11	ELECT	10µF 20% 50V				















REF. NO.	PART NO.	DESCRIPTION	VALUES	REF. NO.	PART NO.	DESCRIPTION	VALUES	
*	CN6400	1-580-843-11	PIN, CONNECTOR (POWER)	D8001	8-719-081-97	DIODE	MMDL914T1	
	CN6401	1-764-101-11	PIN, CONNECTOR (PC BOARD)	2P	D8003	8-719-081-97	DIODE	MMDL914T1
*	CN9405	1-564-507-11	PLUG, CONNECTOR	4P	D8005	8-719-081-97	DIODE	MMDL914T1
*	CN9406	1-564-507-11	PLUG, CONNECTOR	4P	D8006	6-500-567-21	DIODE	10ERB20-TB5
*	CN9407	1-564-507-11	PLUG, CONNECTOR	4P	D8007	8-719-081-97	DIODE	MMDL914T1
DIODE								
D5003	8-719-081-97	DIODE	MMDL914T1	D8009	8-719-072-69	DIODE	PDZ15B-115	
D5005	8-719-081-97	DIODE	MMDL914T1	D8010	8-719-083-78	DIODE	10ERA60-TP	
D5101	8-719-036-94	DIODE	RD5.6SB-T1	D8011	8-719-082-03	DIODE	MM3Z15VT1	
D5102	8-719-908-03	DIODE	GP08D	D8012	8-719-082-03	DIODE	MM3Z15VT1	
D5201	8-719-110-39	DIODE	RD15ESB1	D8015	8-719-081-97	DIODE	MMDL914T1	
D5202	8-719-028-45	DIODE	D2L20U	D8019	8-719-070-10	DIODE	NNCD5.1A-T1	
D5203	8-719-081-97	DIODE	MMDL914T1	D8022	8-719-063-73	DIODE	D1NL20U-TR	
D5204	8-719-081-97	DIODE	MMDL914T1	D8023	8-719-070-10	DIODE	NNCD5.1A-T1	
D5205	8-719-081-97	DIODE	MMDL914T1	D8024	8-719-976-99	DIODE	DTZ5.1B	
D5206	8-719-081-97	DIODE	MMDL914T1	D8026	8-719-081-97	DIODE	MMDL914T1	
D5207	8-719-081-97	DIODE	MMDL914T1	D8027	6-500-654-01	DIODE	MM3Z3V0T1	
D5208	8-719-081-97	DIODE	MMDL914T1	D8030	8-719-056-93	DIODE	UDZ-TE-17-18B	
D5209	8-719-066-11	DIODE	1PS184-115	D8034	8-719-056-83	DIODE	UDZ-TE-17-6.8B	
D5701	8-719-070-57	DIODE	PDZ5.6B-115	D8038	8-719-082-03	DIODE	MM3Z15VT1	
D6401	8-719-083-78	DIODE	10ERA60-TP	D8039	8-719-082-03	DIODE	MM3Z15VT1	
D6406	8-719-082-03	DIODE	MM3Z15VT1	D8041	8-719-082-03	DIODE	MM3Z15VT1	
D6407	8-719-082-03	DIODE	MM3Z15VT1	D8140	8-719-404-50	DIODE	MA111-TX	
D6410	6-500-567-21	DIODE	10ERB20-TB5	D9407	8-719-991-33	DIODE	1SS133T-77	
D6411	8-719-082-03	DIODE	MM3Z15VT1	D9409	8-719-110-17	DIODE	RD10ESB2	
D6413	8-719-082-03	DIODE	MM3Z15VT1	FERRITE BEAD				
D6415	8-719-082-03	DIODE	MM3Z15VT1	FB5201	1-469-578-11	FERRITE	1.1µH	
D6502	8-719-060-88	DIODE	D4SBS6	FB5203	1-469-127-21	FERRITE	0µH	
D6503	8-719-060-88	DIODE	D4SBS6	FB5205	1-469-578-11	FERRITE	1.1µH	
D6504	8-719-510-13	DIODE	D10SC4MR	FB6400	1-469-579-11	FERRITE	0.45µH	
D6508	8-719-062-40	DIODE	D4SBL20µF3	FB6401	1-469-579-11	FERRITE	0.45µH	
D6509	8-719-052-90	DIODE	D1NL40-TA2	FB6402	1-469-579-11	FERRITE	0.45µH	
D6510	8-719-052-37	DIODE	F10P04Q	FB6403	1-469-579-11	FERRITE	0.45µH	
D6601	8-719-078-04	DIODE	EC31QS03L-TE12L	FB6405	1-469-579-11	FERRITE	0.45µH	
D6602	6-500-027-01	DIODE	MM3Z8V2ST1	FB6406	1-469-579-11	FERRITE	0.45µH	
D6603	8-719-081-97	DIODE	MMDL914T1	FB6407	1-469-579-11	FERRITE	0.45µH	
D6606	8-719-028-72	DIODE	RGP02-17EL-6433	FB6408	1-469-579-11	FERRITE	0.45µH	
D6800	8-719-150-92	DIODE	RD33EB3T	FB6500	1-469-579-11	FERRITE	0.45µH	
D6803	8-719-081-97	DIODE	MMDL914T1	FB6501	1-469-579-11	FERRITE	0.45µH	
D6804	6-500-654-01	DIODE	MM3Z3V0T1	FB6506	1-469-578-11	FERRITE	1.1µH	
D6805	8-719-081-97	DIODE	MMDL914T1	FB6507	1-469-578-11	FERRITE	1.1µH	
				FB6508	1-469-578-11	FERRITE	1.1µH	
				FB8001	1-469-579-11	FERRITE	0.45µH	

NOTE: The components identified by shading and  mark are critical for safety. Replace only with part number specified.

NOTE: Les composants identifiés par un trame et une  sont critiques pour la sécurité. Ne les remplacer que par une pièce portant le numéro spécifique.



REF. NO.	PART NO.	DESCRIPTION	VALUES	REF. NO.	PART NO.	DESCRIPTION	VALUES
FB8002	1-469-579-11	FERRITE	0.45μH	L6503	1-412-525-31	INDUCTOR	10μH
FB8003	1-469-579-11	FERRITE	0.45μH	L6504	1-412-525-31	INDUCTOR	10μH
IC				L6505	1-412-525-31	INDUCTOR	10μH
IC5101	8-759-593-33	IC	LA78045	L6508	1-412-525-31	INDUCTOR	10μH
IC5201	8-759-585-82	IC	BA9759F-E2	L6601	1-412-537-31	INDUCTOR	100μH
IC6400	6-705-810-01	IC	MCZ3001DB	L8002	1-428-950-31	INDUCTOR	125μH
IC6501	8-759-458-79	IC	PQ12RD11	L9400	1-414-187-11	INDUCTOR	47μH
IC6503	6-704-264-01	IC	EK1135	L9401	1-414-187-11	INDUCTOR	47μH
IC6601	6-706-502-01	IC	SI-8015JF	L9402	1-414-187-11	INDUCTOR	47μH
IC6801	8-749-921-86	IC	SE-140N	L9403	1-414-187-11	INDUCTOR	47μH
IC8001	8-759-700-07	IC	NJM2903M	L9404	1-412-533-21	INDUCTOR	47μH
IC8002	6-705-810-01	IC	MCZ3001DB	L9405	1-412-533-21	INDUCTOR	47μH
IC8004	8-759-701-01	IC	NJM2904M	L9406	1-412-533-21	INDUCTOR	47μH
IC8005	8-759-586-17	IC	TL1431CZ-AP	L9407	1-412-533-21	INDUCTOR	47μH
IC8104	8-759-586-17	IC	TL1431CZ-AP	PHOTO COUPLER			
IC9400	6-600-383-01	IC	STK394-510	 PH6401	6-600-187-01	PHOTO COUPLER	PC123Y22J00F
IC9401	6-600-383-01	IC	STK394-510	 PH6700	6-600-187-01	PHOTO COUPLER	PC123Y22J00F
CHIP CONDUCTOR				 PH8001	6-600-187-01	PHOTO COUPLER	PC123Y22J00F
JR1016	1-216-864-11	SHORT CHIP		 PH8003	6-600-187-01	PHOTO COUPLER	PC123Y22J00F
JR1020	1-216-864-11	SHORT CHIP		 PH8004	6-600-187-01	PHOTO COUPLER	PC123Y22J00F
JR1021	1-216-864-11	SHORT CHIP		IC LINK			
JR1022	1-216-864-11	SHORT CHIP		 PS6500	1-533-790-42	IC LINK	7A 90V
JR5001	1-216-864-11	SHORT CHIP		 PS6501	1-533-790-42	IC LINK	7A 90V
JR5002	1-216-864-11	SHORT CHIP		 PS9400	1-533-594-32	IC LINK	2.5A 90V
JR5003	1-216-864-11	SHORT CHIP		 PS9401	1-533-594-32	IC LINK	2.5A 90V
JR5004	1-216-864-11	SHORT CHIP		 PS9402	1-533-594-32	IC LINK	2.5A 90V
JR8001	1-216-864-11	SHORT CHIP		 PS9403	1-533-594-32	IC LINK	2.5A 90V
JR8003	1-216-864-11	SHORT CHIP		 PS9404	1-533-594-32	IC LINK	2.5A 90V
JR8004	1-216-864-11	SHORT CHIP		 PS9405	1-533-594-32	IC LINK	2.5A 90V
JR8009	1-216-864-11	SHORT CHIP		TRANSISTOR			
JR8010	1-216-864-11	SHORT CHIP		Q5001	6-550-144-01	TRANSISTOR	2SC5778-YB
COIL				Q5004	8-729-010-25	TRANSISTOR	MSD601-RT1
L5101	1-406-665-11	INDUCTOR	100μH	Q5005	8-729-010-25	TRANSISTOR	MSD601-RT1
L5202	1-414-189-31	INDUCTOR	100μH	Q5006	8-729-038-83	TRANSISTOR	2SK2251-01-F19
L5403	1-456-109-11	COIL,HORIZONTAL LINEARITY(HLC)		Q5008	8-729-010-25	TRANSISTOR	MSD601-RT1
L5405	1-412-552-11	INDUCTOR	2.2MH	Q5009	8-729-010-05	TRANSISTOR	MSB709-RT1
L6400	1-414-187-11	INDUCTOR	47μH	Q5101	8-729-010-25	TRANSISTOR	MSD601-RT1
L6501	1-412-525-31	INDUCTOR	10μH	Q5102	8-729-010-25	TRANSISTOR	MSD601-RT1
L6502	1-412-525-31	INDUCTOR	10μH	Q5103	8-729-010-25	TRANSISTOR	MSD601-RT1
				Q5201	6-550-153-01	TRANSISTOR	FQPF12P20XDTU





REF. NO.	PART NO.	DESCRIPTION	VALUES	REF. NO.	PART NO.	DESCRIPTION	VALUES
Q5202	8-729-010-25	TRANSISTOR	MSD601-RT1	R5101	1-216-845-11	METAL CHIP	100K 5% 1/10W
Q5203	8-729-010-25	TRANSISTOR	MSD601-RT1	R5102	1-216-841-11	METAL CHIP	47K 5% 1/10W
Q5521	8-729-010-05	TRANSISTOR	MSB709-RT1	R5103	1-216-833-11	METAL CHIP	10K 5% 1/10W
Q5522	8-729-046-80	TRANSISTOR	2SC4634LS-CB11	R5104	1-216-833-11	METAL CHIP	10K 5% 1/10W
Q5701	8-729-010-25	TRANSISTOR	MSD601-RT1	R5106	1-216-833-11	METAL CHIP	10K 5% 1/10W
Q5702	8-729-010-05	TRANSISTOR	MSB709-RT1	R5107	1-218-865-11	METAL CHIP	5.6K 0.50% 1/10W
Q6400	6-550-882-01	TRANSISTOR	2SK3568(LBS2SONY,Q	R5108	1-218-865-11	METAL CHIP	5.6K 0.50% 1/10W
Q6401	6-550-882-01	TRANSISTOR	2SK3568(LBS2SONY,Q	R5109	1-216-833-11	METAL CHIP	10K 5% 1/10W
Q6402	8-729-421-22	TRANSISTOR	UN2211	R5110	1-216-833-11	METAL CHIP	10K 5% 1/10W
Q6403	8-729-421-22	TRANSISTOR	UN2211	R5111	1-249-383-11	CARBON	1.5 5% 1/4W
Q6404	8-729-421-22	TRANSISTOR	UN2211	R5112	1-218-865-11	METAL CHIP	5.6K 0.50% 1/10W
Q6802	8-729-010-05	TRANSISTOR	MSB709-RT1	R5113	1-218-865-11	METAL CHIP	5.6K 0.50% 1/10W
Q6803	8-729-019-57	TRANSISTOR	2SA1208S-TP	R5115	1-218-867-11	METAL CHIP	6.8K 0.50% 1/10W
Q8003	8-729-010-25	TRANSISTOR	MSD601-RT1	R5116	1-218-867-11	METAL CHIP	6.8K 0.50% 1/10W
Q8004	8-729-010-25	TRANSISTOR	MSD601-RT1	R5117	1-214-800-11	METAL	2.2 1% 1/2W
Q8007	8-729-010-25	TRANSISTOR	MSD601-RT1	R5118	1-214-800-11	METAL	2.2 1% 1/2W
Q8008	8-729-010-25	TRANSISTOR	MSD601-RT1	R5119	1-243-572-71	METAL OXIDE	470 5% 2W
Q8010	8-729-010-25	TRANSISTOR	MSD601-RT1	R5120	1-243-572-71	METAL OXIDE	470 5% 2W
Q8011	8-729-010-05	TRANSISTOR	MSB709-RT1	R5121	1-249-414-11	CARBON	560 5% 1/4W
Q8013	6-550-882-01	TRANSISTOR	2SK3568(LBS2SONY,Q	R5126	1-218-917-11	METAL CHIP	820K 0.50% 1/10W
Q8014	6-550-882-01	TRANSISTOR	2SK3568(LBS2SONY,Q	R5127	1-216-857-11	METAL CHIP	1M 5% 1/10W
Q8021	8-729-010-05	TRANSISTOR	MSB709-RT1	R5201	1-218-879-11	METAL CHIP	22K 0.50% 1/10W
Q8028	8-729-421-22	TRANSISTOR	UN2211	R5202	1-218-884-11	METAL CHIP	36K 0.50% 1/10W
Q8034	8-729-421-22	TRANSISTOR	UN2211	R5206	1-249-425-11	CARBON	4.7K 5% 1/4W
Q8035	8-729-010-05	TRANSISTOR	MSB709-RT1	R5207	1-218-889-11	METAL CHIP	56K 0.50% 1/10W
RESISTOR				R5208	1-249-409-11	CARBON	220 5% 1/4W
R5001	1-243-619-71	METAL OXIDE	12K 5% 3W	R5209	1-218-895-11	METAL CHIP	100K 0.50% 1/10W
R5002	1-243-619-71	METAL OXIDE	12K 5% 3W	R5210	1-216-845-11	METAL CHIP	100K 5% 1/10W
R5003	1-215-873-00	METAL OXIDE	4.7K 5% 1W	R5211	1-218-895-11	METAL CHIP	100K 0.50% 1/10W
R5010	1-243-801-71	METAL OXIDE	0.22 5% 1W	R5212	1-218-871-11	METAL CHIP	10K 0.50% 1/10W
R5019	1-216-829-11	METAL CHIP	4.7K 5% 1/10W	R5213	1-216-845-11	METAL CHIP	100K 5% 1/10W
R5020	1-216-833-11	METAL CHIP	10K 5% 1/10W	R5214	1-216-845-11	METAL CHIP	100K 5% 1/10W
R5021	1-216-809-11	METAL CHIP	100 5% 1/10W	R5215	1-216-845-11	METAL CHIP	100K 5% 1/10W
R5023	1-216-833-11	METAL CHIP	10K 5% 1/10W	R5216	1-216-833-11	METAL CHIP	10K 5% 1/10W
R5024	1-216-833-11	METAL CHIP	10K 5% 1/10W	R5217	1-218-871-11	METAL CHIP	10K 0.50% 1/10W
R5025	1-216-809-11	METAL CHIP	100 5% 1/10W	R5221	1-218-895-11	METAL CHIP	100K 0.50% 1/10W
R5028	1-216-821-11	METAL CHIP	1K 5% 1/10W	R5223	1-218-895-11	METAL CHIP	100K 0.50% 1/10W
R5029	1-216-833-11	METAL CHIP	10K 5% 1/10W	R5241	1-216-821-11	METAL CHIP	1K 5% 1/10W
R5031	1-249-393-11	CARBON	10 5% 1/4W	R5243	1-216-843-11	METAL CHIP	68K 5% 1/10W
R5032	1-216-841-11	METAL CHIP	47K 5% 1/10W	R5245	1-216-833-11	METAL CHIP	10K 5% 1/10W
R5033	1-249-401-11	CARBON	47 5% 1/4W	R5247	1-216-829-11	METAL CHIP	4.7K 5% 1/10W
				R5249	1-216-837-11	METAL CHIP	22K 5% 1/10W
				R5250	1-218-871-11	METAL CHIP	10K 0.50% 1/10W
				R5251	1-218-895-11	METAL CHIP	100K 0.50% 1/10W

NOTE: The components identified by shading and  mark are critical for safety. Replace only with part number specified.

NOTE: Les composants identifiés par un trame et une  sont critiques pour la sécurité. Ne les remplacer que par une pièce portant le numéro spécifique.



REF. NO.	PART NO.	DESCRIPTION	VALUES			REF. NO.	PART NO.	DESCRIPTION	VALUES		
R5252	1-218-895-11	METAL CHIP	100K	0.50%	1/10W	R6603	1-216-825-11	METAL CHIP	2.2K	5%	1/10W
R5415	1-243-693-71	METAL OXIDE	270	5%	1W	R6604	1-218-874-11	METAL CHIP	13K	0.50%	1/10W
R5435	1-260-314-11	CARBON	68	5%	1/2W	R6605	1-218-861-11	METAL CHIP	3.9K	0.50%	1/10W
R5436	1-249-389-11	CARBON	4.7	5%	1/4W	R6612	1-249-377-11	CARBON	0.47	5%	1/4W
R5581	1-216-833-11	METAL CHIP	10K	5%	1/10W	R6700	1-216-817-11	METAL CHIP	470	5%	1/10W
R5582	1-249-441-11	CARBON	100K	5%	1/4W	R6702	1-216-821-11	METAL CHIP	1K	5%	1/10W
R5583	1-260-107-11	CARBON	4.7K	5%	1/2W	R6703	1-218-484-11	METAL CHIP	750	5%	1/10W
R5584	1-249-441-11	CARBON	100K	5%	1/4W	R6704	1-218-484-11	METAL CHIP	750	5%	1/10W
R5585	1-249-441-11	CARBON	100K	5%	1/4W	R6705	1-216-833-11	METAL CHIP	10K	5%	1/10W
R5586	1-216-827-11	METAL CHIP	3.3K	5%	1/10W	R6809	1-249-423-11	CARBON	3.3K	5%	1/4W
R5587	1-216-833-11	METAL CHIP	10K	5%	1/10W	R6810	1-216-821-11	METAL CHIP	1K	5%	1/10W
R5588	1-249-441-11	CARBON	100K	5%	1/4W	R6811	1-216-825-11	METAL CHIP	2.2K	5%	1/10W
R5589	1-216-842-11	METAL CHIP	56K	5%	1/10W	R6812	1-243-511-71	METAL OXIDE	2.2	5%	3W
R5701	1-249-425-11	CARBON	4.7K	5%	1/4W	R6813	1-216-833-11	METAL CHIP	10K	5%	1/10W
R5702	1-216-841-11	METAL CHIP	47K	5%	1/10W	R6814	1-218-855-11	METAL CHIP	2.2K	0.50%	1/10W
R6402	1-218-870-11	METAL CHIP	9.1K	0.50%	1/10W	R6815	1-216-837-11	METAL CHIP	22K	5%	1/10W
R6405	1-218-823-11	METAL CHIP	100	0.50%	1/10W	R6816	1-216-846-11	METAL CHIP	120K	5%	1/10W
R6406	1-245-478-21	METAL	470K	1%	1/4W	R6817	1-216-846-11	METAL CHIP	120K	5%	1/10W
R6407	1-218-875-11	METAL CHIP	15K	0.50%	1/10W	R6818	1-245-471-21	METAL	240K	1%	1/4W
R6409	1-218-830-11	METAL CHIP	200	0.50%	1/10W	R6821	1-245-471-21	METAL	240K	1%	1/4W
R6411	1-249-393-11	CARBON	10	5%	1/4W	R8001	1-219-512-11	METAL	2.2M	5%	1/2W
R6412	1-249-393-11	CARBON	10	5%	1/4W	R8002	1-219-512-11	METAL	2.2M	5%	1/2W
R6413	1-216-833-11	METAL CHIP	10K	5%	1/10W	R8003	1-216-839-11	METAL CHIP	33K	5%	1/10W
R6414	1-216-833-11	METAL CHIP	10K	5%	1/10W	R8004	1-216-829-11	METAL CHIP	4.7K	5%	1/10W
R6417	1-245-315-71	METAL OXIDE	0.1	5%	2W	R8005	1-216-837-11	METAL CHIP	22K	5%	1/10W
R6418	1-245-315-71	METAL OXIDE	0.1	5%	2W	R8008	1-218-877-11	METAL CHIP	18K	0.50%	1/10W
R6420	1-249-393-11	CARBON	10	5%	1/4W	R8010	1-218-484-11	METAL CHIP	750	5%	1/10W
 R6421	1-202-933-61	FUSIBLE	0.1	10%	1/2W	R8011	1-216-849-11	METAL CHIP	220K	5%	1/10W
R6422	1-249-377-11	CARBON	0.47	5%	1/4W	R8012	1-218-484-11	METAL CHIP	750	5%	1/10W
R6423	1-216-845-11	METAL CHIP	100K	5%	1/10W	R8013	1-216-833-11	METAL CHIP	10K	5%	1/10W
R6424	1-249-433-11	CARBON	22K	5%	1/4W	R8014	1-218-847-11	METAL CHIP	1K	0.50%	1/10W
R6425	1-216-821-11	METAL CHIP	1K	5%	1/10W	R8015	1-218-855-11	METAL CHIP	2.2K	0.50%	1/10W
R6426	1-216-833-11	METAL CHIP	10K	5%	1/10W	R8016	1-247-843-11	CARBON	3.3K	5%	1/4W
R6427	1-216-857-11	METAL CHIP	1M	5%	1/10W	R8017	1-218-855-11	METAL CHIP	2.2K	0.50%	1/10W
R6428	1-216-857-11	METAL CHIP	1M	5%	1/10W	 R8019	1-218-875-11	METAL CHIP	15K	0.50%	1/10W
R6429	1-245-478-21	METAL	470K	1%	1/4W	R8020	1-216-833-11	METAL CHIP	10K	5%	1/10W
R6500	1-216-833-11	METAL CHIP	10K	5%	1/10W	R8022	1-216-839-11	METAL CHIP	33K	5%	1/10W
R6501	1-216-833-11	METAL CHIP	10K	5%	1/10W	R8024	1-216-839-11	METAL CHIP	33K	5%	1/10W
R6503	1-215-925-11	METAL OXIDE	22K	5%	3W	R8025	1-216-821-11	METAL CHIP	1K	5%	1/10W
R6504	1-260-298-51	CARBON	3.3	5%	1/2W	R8026	1-218-855-11	METAL CHIP	2.2K	0.50%	1/10W
R6515	1-249-377-11	CARBON	0.47	5%	1/4W	R8027	1-218-891-11	METAL CHIP	68K	0.50%	1/10W
R6590	1-249-409-11	CARBON	220	5%	1/4W	R8028	1-218-871-11	METAL CHIP	10K	0.50%	1/10W
R6601	1-218-858-11	METAL CHIP	3K	0.50%	1/10W	R8029	1-218-891-11	METAL CHIP	68K	0.50%	1/10W
R6602	1-218-847-11	METAL CHIP	1K	0.50%	1/10W	R8030	1-218-895-11	METAL CHIP	100K	0.50%	1/10W

NOTE: The components identified by shading and \triangle mark are critical for safety. Replace only with part number specified.

NOTE: Les composants identifiés par un trame et une marque \triangle sont critiques pour la sécurité. Ne les remplacer que par une pièce portant le numéro spécifié.













REF. NO.	PART NO.	DESCRIPTION	VALUES			REF. NO.	PART NO.	DESCRIPTION	VALUES		
R8031	1-218-895-11	METAL CHIP	100K	0.50%	1/10W	R8145	1-216-841-11	METAL CHIP	47K	5%	1/10W
R8032	1-216-817-11	METAL CHIP	470	5%	1/10W	R8146	1-216-821-11	METAL CHIP	1K	5%	1/10W
R8033	1-216-841-11	METAL CHIP	47K	5%	1/10W	R8158	1-216-809-11	METAL CHIP	100	5%	1/10W
\triangle R8035	1-218-861-11	METAL CHIP	3.9K	0.50%	1/10W	R8159	1-216-835-11	METAL CHIP	15K	5%	1/10W
\triangle R8036	1-215-419-00	METAL	820	1%	1/4W	R8160	1-216-853-11	METAL CHIP	470K	5%	1/10W
\triangle R8037	1-215-447-00	METAL	12K	1%	1/4W	R8161	1-216-833-11	METAL CHIP	10K	5%	1/10W
\triangle R8038	1-215-447-00	METAL	12K	1%	1/4W	\triangle R8165	1-218-897-11	METAL CHIP	120K	0.50%	1/10W
\triangle R8039	1-215-447-00	METAL	12K	1%	1/4W	R8166	1-216-809-11	METAL CHIP	100	5%	1/10W
\triangle R8040	1-215-445-00	METAL	10K	1%	1/4W	R9407	1-218-823-11	METAL CHIP	100	0.50%	1/10W
\triangle R8041	1-216-864-11	SHORT CHIP				R9408	1-218-823-11	METAL CHIP	100	0.50%	1/10W
\triangle R8043	1-215-447-00	METAL	12K	1%	1/4W	R9409	1-218-823-11	METAL CHIP	100	0.50%	1/10W
R8046	1-218-855-11	METAL CHIP	2.2K	0.50%	1/10W	R9410	1-216-809-11	METAL CHIP	100	5%	1/10W
R8049	1-218-823-11	METAL CHIP	100	0.50%	1/10W	R9411	1-218-863-11	METAL CHIP	4.7K	0.50%	1/10W
R8050	1-211-979-11	METAL CHIP	27	0.50%	1/10W	R9412	1-218-823-11	METAL CHIP	100	0.50%	1/10W
R8051	1-202-933-61	FUSIBLE	0.1	10%	1/2W	R9413	1-218-823-11	METAL CHIP	100	0.50%	1/10W
R8052	1-218-893-11	METAL CHIP	82K	0.50%	1/10W	R9414	1-218-823-11	METAL CHIP	100	0.50%	1/10W
R8054	1-245-478-21	METAL	470K	1%	1/4W	R9415	1-218-863-11	METAL CHIP	4.7K	0.50%	1/10W
R8055	1-245-478-21	METAL	470K	1%	1/4W	R9416	1-218-863-11	METAL CHIP	4.7K	0.50%	1/10W
R8056	1-218-870-11	METAL CHIP	9.1K	0.50%	1/10W	R9417	1-216-809-11	METAL CHIP	100	5%	1/10W
R8057	1-218-874-11	METAL CHIP	13K	0.50%	1/10W	R9418	1-218-863-11	METAL CHIP	4.7K	0.50%	1/10W
R8058	1-249-393-11	CARBON	10	5%	1/4W	R9419	1-218-863-11	METAL CHIP	4.7K	0.50%	1/10W
R8060	1-218-839-11	METAL CHIP	470	0.50%	1/10W	R9420	1-218-863-11	METAL CHIP	4.7K	0.50%	1/10W
R8061	1-249-393-11	CARBON	10	5%	1/4W	R9424	1-218-863-11	METAL CHIP	4.7K	0.50%	1/10W
R8062	1-216-833-11	METAL CHIP	10K	5%	1/10W	R9425	1-218-863-11	METAL CHIP	4.7K	0.50%	1/10W
R8063	1-216-833-11	METAL CHIP	10K	5%	1/10W	R9427	1-214-808-11	METAL	4.7	1%	1/2W
R8066	1-216-821-11	METAL CHIP	1K	5%	1/10W	R9428	1-214-808-11	METAL	4.7	1%	1/2W
R8069	1-249-425-11	CARBON	4.7K	5%	1/4W	R9430	1-214-808-11	METAL	4.7	1%	1/2W
R8070	1-245-315-71	METAL OXIDE	0.1	5%	2W	R9432	1-214-808-11	METAL	4.7	1%	1/2W
R8072	1-249-377-11	CARBON	0.47	5%	1/4W	R9433	1-218-863-11	METAL CHIP	4.7K	0.50%	1/10W
R8073	1-216-857-11	METAL CHIP	1M	5%	1/10W	R9434	1-214-808-11	METAL	4.7	1%	1/2W
R8074	1-216-857-11	METAL CHIP	1M	5%	1/10W	R9435	1-218-863-11	METAL CHIP	4.7K	0.50%	1/10W
R8076	1-249-411-11	CARBON	330	5%	1/4W	R9436	1-214-808-11	METAL	4.7	1%	1/2W
\triangle R8078	1-218-895-11	METAL CHIP	100K	0.50%	1/10W	R9437	1-214-808-11	METAL	4.7	1%	1/2W
R8079	1-215-449-00	METAL	15K	1%	1/4W	R9438	1-214-808-11	METAL	4.7	1%	1/2W
R8082	1-216-863-11	METAL CHIP	3.3M	5%	1/10W	R9440	1-214-808-11	METAL	4.7	1%	1/2W
R8085	1-219-749-91	METAL	10K	5%	1/2W	R9441	1-214-808-11	METAL	4.7	1%	1/2W
R8086	1-219-750-91	METAL	22K	5%	1/2W	R9442	1-214-808-11	METAL	4.7	1%	1/2W
R8092	1-249-377-11	CARBON	0.47	5%	1/4W	R9443	1-214-808-11	METAL	4.7	1%	1/2W
R8096	1-216-817-11	METAL CHIP	470	5%	1/10W	R9446	1-214-808-11	METAL	4.7	1%	1/2W
R8097	1-216-797-11	METAL CHIP	10	5%	1/10W	R9447	1-214-808-11	METAL	4.7	1%	1/2W
R8099	1-218-839-11	METAL CHIP	470	0.50%	1/10W	R9448	1-218-863-11	METAL CHIP	4.7K	0.50%	1/10W
R8137	1-216-821-11	METAL CHIP	1K	5%	1/10W	R9450	1-218-887-11	METAL CHIP	47K	0.50%	1/10W
R8138	1-216-857-11	METAL CHIP	1M	5%	1/10W	R9451	1-214-808-11	METAL	4.7	1%	1/2W
R8144	1-216-849-11	METAL CHIP	220K	5%	1/10W	R9452	1-214-808-11	METAL	4.7	1%	1/2W

NOTE: The components identified by shading and  mark are critical for safety. Replace only with part number specified.

A component identified by this  symbol indicates that it has been carefully factory-selected to satisfy regulations regarding X-ray radiation. Should replacement be required, replace only with the value originally used.



REF. NO.	PART NO.	DESCRIPTION	VALUES			REF. NO.	PART NO.	DESCRIPTION	VALUES		
R9453	1-218-863-11	METAL CHIP	4.7K	0.50%	1/10W						
R9454	1-214-808-11	METAL	4.7	1%	1/2W						
R9455	1-214-808-11	METAL	4.7	1%	1/2W						
R9456	1-214-808-11	METAL	4.7	1%	1/2W						
R9457	1-214-808-11	METAL	4.7	1%	1/2W						
R9458	1-214-808-11	METAL	4.7	1%	1/2W						
R9459	1-214-808-11	METAL	4.7	1%	1/2W						
R9460	1-214-808-11	METAL	4.7	1%	1/2W						
R9461	1-214-808-11	METAL	4.7	1%	1/2W						
R9462	1-214-808-11	METAL	4.7	1%	1/2W						
R9463	1-214-808-11	METAL	4.7	1%	1/2W						
R9464	1-214-808-11	METAL	4.7	1%	1/2W						
R9465	1-214-808-11	METAL	4.7	1%	1/2W						
R9466	1-243-532-71	METAL OXIDE	120	5%	3W						
R9467	1-243-532-71	METAL OXIDE	120	5%	3W						
R9468	1-214-808-11	METAL	4.7	1%	1/2W						
R9470	1-214-808-11	METAL	4.7	1%	1/2W						
R9471	1-243-532-71	METAL OXIDE	120	5%	3W						
R9472	1-243-532-71	METAL OXIDE	120	5%	3W						
R9473	1-243-532-71	METAL OXIDE	120	5%	3W						
R9474	1-243-532-71	METAL OXIDE	120	5%	3W						
<u>VARIABLE RESISTOR</u>											
	RV8002	1-225-627-91	RES, VAR, ADJ, CERMET	2K							
<u>SPARK GAP</u>											
SG5500	1-519-466-11	GAP, SPARK									
SG8002	1-517-499-21	GAP, SPARK									
<u>TRANSFORMER</u>											
T5001	1-437-739-11	TRANSFORMER, FERRITE (HDT)									
T5002	1-443-395-11	FERRITE TRANSFORMER (HOT)									
T5500	1-443-394-11	TRANSFORMER, FERRITE (DFT)									
	T6400	1-439-821-11	TRANSFORMER, CONVERTER (PIT)								
	T8001	1-453-450-11	FBT ASSY NX-6030/M3A4								
											
						*	A-1065-549-A	G BOARD, COMPLETE			
							4-382-854-01	SCREW (M3X8), P, SW (+)			
<u>CAPACITOR</u>											
	C6001	1-165-530-31	MYLAR	0.47µF	10	0V					
	C6002	1-119-894-51	CERAMIC	2200pF	20%	250V					
	C6003	1-165-530-31	MYLAR	0.47µF	10	0V					
	C6004	1-119-894-51	CERAMIC	2200pF	20%	250V					
	C6006	1-113-889-11	CERAMIC	0.001µF	20%	250V					
	C6007	1-161-964-91	CERAMIC	0.0047µF		250V					
	C6008	1-161-964-91	CERAMIC	0.0047µF		250V					
	C6011	1-137-750-11	ELECT	1500µF	20%	250V					
	C6012	1-137-750-11	ELECT	1500µF	20%	250V					
	C6013	1-119-894-51	CERAMIC	2200pF	20%	250V					
	C6015	1-119-894-51	CERAMIC	2200pF	20%	250V					
	C6112	1-126-965-91	ELECT	22µF	20%	50V					
	C6115	1-131-970-11	ELECT	1500µF	20%	25V					
	C6116	1-126-967-11	ELECT	47µF	20%	50V					
	C6120	1-126-968-11	ELECT	100µF	20%	50V					
	C6127	1-162-966-11	CERAMIC CHIP	0.0022µF	10%	50V					
	C6900	1-137-639-21	MYLAR	0.47µF	10%	450V					
	C6902	1-162-964-11	CERAMIC CHIP	0.001µF	10%	50V					
	C6903	1-126-964-11	ELECT	10µF	20%	50V					
	C6904	1-126-959-11	ELECT	0.47µF	20%	50V					
	C6906	1-126-967-11	ELECT	47µF	20%	50V					
	C6907	1-162-970-11	CERAMIC CHIP	0.01µF	10%	25V					
	C6908	1-136-479-11	FILM	0.001µF	5%	100V					
	C6909	1-136-497-81	FILM	0.1µF	5%	50V					
	C6911	1-126-947-11	ELECT	47µF	20%	35V					
	C6914	1-117-219-11	CERAMIC	68pF	5%	1KV					
	C6915	1-117-219-11	CERAMIC	68pF	5%	1KV					
	C6916	1-100-624-11	FILM	4700pF	3%	800V					
	C6917	1-126-968-11	ELECT	100µF	20%	50V					
	C6918	1-126-968-11	ELECT	100µF	20%	50V					
	C6919	1-126-926-11	ELECT	1000µF	20%	10V					
	C6921	1-128-547-11	ELECT	6800µF	20%	16V					
	C6923	1-126-933-11	ELECT	100µF	20%	16V					
	C6925	1-162-970-11	CERAMIC CHIP	0.01µF	10%	25V					
	C6926	1-126-768-11	ELECT	2200µF	20%	16V					

NOTE: The components identified by shading and \triangle mark are critical for safety. Replace only with part number specified.

NOTE: Les composants identifiés par un trame et une marque \triangle sont critiques pour la sécurité. Ne les remplacer que par une pièce portant le numéro spécifique.



REF. NO.	PART NO.	DESCRIPTION	VALUES	REF. NO.	PART NO.	DESCRIPTION	VALUES
C6929	1-126-935-11	ELECT	470 μ F 20% 16V				
C6930	1-162-970-11	CERAMIC CHIP	0.01 μ F 10% 25V				
CONNECTOR				FERRITE BEAD			
* CN6000	1-580-843-11	PIN, CONNECTOR (POWER)		FB6900	1-469-578-11	FERRITE	1.1 μ H
* \triangle CN6001	1-580-843-11	PIN, CONNECTOR (POWER)		FUSE HOLDER			
CN6004	1-695-915-11	TAB (CONTACT)		\triangle FH6000	1-533-223-11	FUSE HOLDER	0A 0V
CN6012	1-564-507-11	PLUG, CONNECTOR	4P	\triangle FH6001	1-533-223-11	FUSE HOLDER	0A 0V
CN6901	1-764-101-11	PIN, CONNECTOR (PC BOARD)	2P	IC			
CN6902	1-564-509-11	PLUG, CONNECTOR	6P	IC6100	8-759-450-47	IC	BA05T
DIODE				IC6900	8-759-670-30	IC	MCZ3001D
D6000	8-719-081-97	DIODE	MMDL914T1	IC6901	8-759-586-17	IC	TL1431CZ-AP
D6005	8-719-022-99	DIODE	D6SB60L	IC6902	8-759-470-65	IC	PQ05RD1B
D6006	8-719-083-78	DIODE	10ERA60-TP	CHIP CONDUCTOR			
D6007	8-719-083-78	DIODE	10ERA60-TP	JR6000	1-216-864-11	SHORT CHIP	
D6108	8-719-056-93	DIODE	UDZ-TE-17-18B	JR6001	1-216-864-11	SHORT CHIP	
D6109	8-719-510-02	DIODE	D1NS4	JR6002	1-216-864-11	SHORT CHIP	
D6113	6-500-582-01	DIODE	KBP153G-A2	JUMPER WIRE			
D6115	8-719-081-97	DIODE	MMDL914T1	JW6042	1-469-578-11	FERRITE	1.1 μ H
D6116	8-719-081-97	DIODE	MMDL914T1	COIL			
D6117	8-719-081-97	DIODE	MMDL914T1	\triangle L6000	1-433-900-31	TRANSFORMER, LINE FILTER	
D6118	6-500-555-01	DIODE	MM3Z27VT1	\triangle L6001	1-433-900-31	TRANSFORMER, LINE FILTER	
D6119	8-719-081-97	DIODE	MMDL914T1	L6002	1-406-977-21	INDUCTOR	100 μ H
D6120	8-719-081-97	DIODE	MMDL914T1	L6900	1-412-537-31	INDUCTOR	100 μ H
D6123	8-719-081-97	DIODE	MMDL914T1	L6902	1-412-525-31	INDUCTOR	10 μ H
D6301	6-500-567-21	DIODE	10ERB20-TB5	L6903	1-406-659-11	INDUCTOR	10 μ H
D6901	8-719-083-78	DIODE	10ERA60-TP	PHOTO COUPLER			
D6902	8-719-082-03	DIODE	MM3Z15VT1	\triangle PH6900	6-600-187-01	PHOTO COUPLER	PC123Y22JOOF
D6903	8-719-082-03	DIODE	MM3Z15VT1	TRANSISTOR			
D6904	8-719-082-03	DIODE	MM3Z15VT1	Q6102	8-729-010-25	TRANSISTOR	MSD601-RT1
D6905	8-719-082-03	DIODE	MM3Z15VT1	Q6107	8-729-140-96	TRANSISTOR	2SD774-34
D6907	6-500-567-21	DIODE	10ERB20-TB5	Q6109	8-729-010-05	TRANSISTOR	MSB709-RT1
D6908	6-500-567-21	DIODE	10ERB20-TB5	Q6110	8-729-010-05	TRANSISTOR	MSB709-RT1
D6909	8-719-022-97	DIODE	D2S4UF	Q6111	8-729-010-25	TRANSISTOR	MSD601-RT1
D6910	8-719-510-12	DIODE	D10SC4M	FUSE			
D6913	8-719-068-71	DIODE	PTZ-TE25-13A	\triangle F6000	1-576-753-11	FUSE	6.3A 250V
D6914	8-719-082-03	DIODE	MM3Z15VT1	TRANSISTOR			

NOTE: The components identified by shading and \triangle mark are critical for safety. Replace only with part number specified.

NOTE: Les composants identifiés par un trame et une marque \triangle sont critiques pour la sécurité. Ne les remplacer que par une pièce portant le numéro spécifique.



REF. NO.	PART NO.	DESCRIPTION	VALUES			REF. NO.	PART NO.	DESCRIPTION	VALUES		
Q6112	8-729-010-25	TRANSISTOR	MSD601-RT1			R6931	1-218-877-11	METAL CHIP	18K	0.50%	1/10W
Q6900	8-729-052-29	TRANSISTOR	2SK2876-01MR-F122			R6932	1-218-867-11	METAL CHIP	6.8K	0.50%	1/10W
Q6901	8-729-052-29	TRANSISTOR	2SK2876-01MR-F122			RELAY					
RESISTOR						\triangle RY6000	1-755-395-11	RELAY (AC POWER)			
\triangle R6001	1-219-568-91	METAL	8.2M	5%	1/2W	TRANSFORMER					
R6002	1-240-303-31	CEMENTED	0.22	5%	10W	\triangle T6101	1-437-783-11	TRANSFORMER, STANDBY			
R6004	1-240-303-31	CEMENTED	0.22	5%	10W	\triangle T6900	1-439-879-11	TRANSFORMER, CONVERTER (PIT)			
R6012	1-219-510-11	METAL	470K	5%	1/2W	VARISTOR					
R6013	1-219-510-11	METAL	470K	5%	1/2W	\triangle VD6000	1-804-992-21	VARISTOR			
R6111	1-216-833-11	METAL CHIP	10K	5%	1/10W	VD6100	1-804-499-21	VARISTOR, CHIP	(1608)		
R6113	1-216-821-11	METAL CHIP	1K	5%	1/10W	P					
R6115	1-216-837-11	METAL CHIP	22K	5%	1/10W	* A-1068-754-A P BOARD, COMPLETE					
R6119	1-216-837-11	METAL CHIP	22K	5%	1/10W	4-382-854-01 SCREW (M3X8), P, SW (+)					
R6120	1-216-841-11	METAL CHIP	47K	5%	1/10W	7-685-872-09 SCREW +BVTT 3X8 (S)					
R6121	1-216-841-11	METAL CHIP	47K	5%	1/10W	Due to the complexity of this board, performing component level field repairs is not recommended. If service is required, complete board replacement is the preferred repair method. Data is provided for reference only.					
R6124	1-216-841-11	METAL CHIP	47K	5%	1/10W	CAPACITOR					
R6125	1-216-841-11	METAL CHIP	47K	5%	1/10W	C9507	1-162-970-11	CERAMIC CHIP	0.01 μ F	10%	25V
R6126	1-216-837-11	METAL CHIP	22K	5%	1/10W	C9508	1-126-394-11	ELECT CHIP	10 μ F	20%	16V
R6127	1-216-841-11	METAL CHIP	47K	5%	1/10W	C9509	1-162-966-11	CERAMIC CHIP	0.0022 μ F	10%	50V
R6128	1-216-841-11	METAL CHIP	47K	5%	1/10W	C9510	1-164-230-11	CERAMIC CHIP	220pF	5%	50V
R6129	1-216-841-11	METAL CHIP	47K	5%	1/10W	C9511	1-162-966-11	CERAMIC CHIP	0.0022 μ F	10%	50V
R6130	1-216-841-11	METAL CHIP	47K	5%	1/10W	C9513	1-162-966-11	CERAMIC CHIP	0.0022 μ F	10%	50V
R6902	1-218-869-11	METAL CHIP	8.2K	0.50%	1/10W	C9514	1-126-394-11	ELECT CHIP	10 μ F	20%	16V
R6903	1-218-837-11	METAL CHIP	390	0.50%	1/10W	C9515	1-126-394-11	ELECT CHIP	10 μ F	20%	16V
R6904	1-245-478-21	METAL	470K	1%	1/4W	C9516	1-107-826-11	CERAMIC CHIP	0.1 μ F	10%	16V
R6905	1-218-873-11	METAL CHIP	12K	0.50%	1/10W	C9517	1-126-394-11	ELECT CHIP	10 μ F	20%	16V
R6907	1-245-478-21	METAL	470K	1%	1/4W	C9519	1-100-566-91	CERAMIC CHIP	0.1 μ F	10%	25V
R6908	1-218-823-11	METAL CHIP	100	0.50%	1/10W	C9521	1-162-964-11	CERAMIC CHIP	0.001 μ F	10%	50V
R6909	1-212-897-00	FUSIBLE	470	5%	1/4W	C9522	1-162-964-11	CERAMIC CHIP	0.001 μ F	10%	50V
R6910	1-249-393-11	CARBON	10	5%	1/4W	C9524	1-100-566-91	CERAMIC CHIP	0.1 μ F	10%	25V
R6911	1-249-393-11	CARBON	10	5%	1/4W	C9525	1-100-566-91	CERAMIC CHIP	0.1 μ F	10%	25V
R6912	1-216-833-11	METAL CHIP	10K	5%	1/10W	C9526	1-126-394-11	ELECT CHIP	10 μ F	20%	16V
R6913	1-216-833-11	METAL CHIP	10K	5%	1/10W	C9527	1-164-505-11	CERAMIC CHIP	2.2 μ F		16V
R6916	1-216-817-11	METAL CHIP	470	5%	1/10W	C9528	1-126-246-11	ELECT CHIP	220 μ F	20%	4V
R6917	1-216-864-11	SHORT CHIP				C9529	1-107-826-11	CERAMIC CHIP	0.1 μ F	10%	16V
\triangle R6918	1-220-926-81	FUSIBLE	0.47	10%	1/2W						
R6920	1-216-363-21	METAL OXIDE	0.33	5%	2W						
R6921	1-216-821-11	METAL CHIP	1K	5%	1/10W						
R6922	1-249-393-11	CARBON	10	5%	1/4W						
R6923	1-216-821-11	METAL CHIP	1K	5%	1/10W						
R6924	1-216-864-11	SHORT CHIP									
R6925	1-249-393-11	CARBON	10	5%	1/4W						
R6927	1-216-833-11	METAL CHIP	10K	5%	1/10W						



REF. NO.	PART NO.	DESCRIPTION	VALUES	REF. NO.	PART NO.	DESCRIPTION	VALUES
C9530	1-126-394-11	ELECT CHIP	10µF 20% 16V	C9826	1-162-919-11	CERAMIC CHIP	22pF 5% 50V
C9531	1-126-394-11	ELECT CHIP	10µF 20% 16V	C9828	1-126-394-11	ELECT CHIP	10µF 20% 16V
C9532	1-126-394-11	ELECT CHIP	10µF 20% 16V	C9830	1-100-566-91	CERAMIC CHIP	0.1µF 10% 25V
C9533	1-100-566-91	CERAMIC CHIP	0.1µF 10% 25V	C9831	1-126-394-11	ELECT CHIP	10µF 20% 16V
C9534	1-100-566-91	CERAMIC CHIP	0.1µF 10% 25V	C9832	1-107-826-11	CERAMIC CHIP	0.1µF 10% 16V
C9535	1-100-566-91	CERAMIC CHIP	0.1µF 10% 25V	C9833	1-100-566-91	CERAMIC CHIP	0.1µF 10% 25V
C9537	1-107-826-11	CERAMIC CHIP	0.1µF 10% 16V	C9835	1-100-588-21	ELECT CHIP	1000µF 20% 6.3V
C9538	1-162-964-11	CERAMIC CHIP	0.001µF 10% 50V	C9836	1-126-394-11	ELECT CHIP	10µF 20% 16V
C9540	1-100-566-91	CERAMIC CHIP	0.1µF 10% 25V	C9839	1-126-394-11	ELECT CHIP	10µF 20% 16V
C9541	1-107-826-11	CERAMIC CHIP	0.1µF 10% 16V	C9841	1-100-118-21	ELECT CHIP	82µF 20% 16V
C9542	1-126-394-11	ELECT CHIP	10µF 20% 16V	C9842	1-137-897-21	ELECT CHIP	150µF 20% 4V
C9543	1-162-966-11	CERAMIC CHIP	0.0022µF 10% 50V	C9843	1-107-826-11	CERAMIC CHIP	0.1µF 10% 16V
C9545	1-162-966-11	CERAMIC CHIP	0.0022µF 10% 50V			CONNECTOR	
C9546	1-164-230-11	CERAMIC CHIP	220pF 5% 50V	* CN9500	1-818-400-11	HDMI CONNECTOR	
C9547	1-107-826-11	CERAMIC CHIP	0.1µF 10% 16V	CN9504	1-564-593-11	PLUG, CONNECTOR	14P
C9549	1-100-566-91	CERAMIC CHIP	0.1µF 10% 25V			DIODE	
C9550	1-100-566-91	CERAMIC CHIP	0.1µF 10% 25V	D9500	8-719-210-39	DIODE	EC10QS-04
C9551	1-100-566-91	CERAMIC CHIP	0.1µF 10% 25V	D9501	6-500-294-01	DIODE	PTZ-TE25-3.9B
C9552	1-126-246-11	ELECT CHIP	220µF 20% 4V	D9502	8-719-977-28	DIODE	DTZ10B
C9553	1-162-966-11	CERAMIC CHIP	0.0022µF 10% 50V	D9503	8-719-977-28	DIODE	DTZ10B
C9554	1-126-394-11	ELECT CHIP	10µF 20% 16V	D9506	8-719-404-50	DIODE	MA111-TX
C9555	1-126-394-11	ELECT CHIP	10µF 20% 16V	D9507	8-719-404-50	DIODE	MA111-TX
C9557	1-100-566-91	CERAMIC CHIP	0.1µF 10% 25V			FERRITE BEAD	
C9558	1-107-826-11	CERAMIC CHIP	0.1µF 10% 16V	FB9504	1-414-235-22	FERRITE	0µH
C9559	1-126-394-11	ELECT CHIP	10µF 20% 16V	FB9505	1-414-235-22	FERRITE	0µH
C9560	1-126-246-11	ELECT CHIP	220µF 20% 4V	FB9506	1-414-235-22	FERRITE	0µH
C9561	1-100-756-91	CERAMIC CHIP	0.047µF 50V	FB9507	1-414-235-22	FERRITE	0µH
C9562	1-127-692-11	CERAMIC CHIP	10µF 10% 16V	FB9508	1-414-235-22	FERRITE	0µH
C9563	1-126-394-11	ELECT CHIP	10µF 20% 16V	FB9509	1-414-235-22	FERRITE	0µH
C9571	1-126-394-11	ELECT CHIP	10µF 20% 16V	FB9510	1-414-235-22	FERRITE	0µH
C9575	1-162-970-11	CERAMIC CHIP	0.01µF 10% 25V	FB9512	1-414-235-22	FERRITE	0µH
C9576	1-126-394-11	ELECT CHIP	10µF 20% 16V			FILTER	
C9578	1-162-916-11	CERAMIC CHIP	12pF 5% 50V	* FL9501	1-813-308-11	INDUCTOR	0µH
C9579	1-162-916-11	CERAMIC CHIP	12pF 5% 50V	* FL9504	1-813-308-11	INDUCTOR	0µH
C9583	1-107-826-11	CERAMIC CHIP	0.1µF 10% 16V	* FL9505	1-813-308-11	INDUCTOR	0µH
C9584	1-100-566-91	CERAMIC CHIP	0.1µF 10% 25V	* FL9506	1-813-308-11	INDUCTOR	0µH
C9585	1-100-566-91	CERAMIC CHIP	0.1µF 10% 25V				
C9586	1-100-566-91	CERAMIC CHIP	0.1µF 10% 25V				
C9587	1-100-566-91	CERAMIC CHIP	0.1µF 10% 25V				
C9588	1-100-566-91	CERAMIC CHIP	0.1µF 10% 25V				
C9589	1-100-566-91	CERAMIC CHIP	0.1µF 10% 25V				
C9623	1-100-566-91	CERAMIC CHIP	0.1µF 10% 25V				
C9824	1-162-919-11	CERAMIC CHIP	22pF 5% 50V				
C9825	1-162-919-11	CERAMIC CHIP	22pF 5% 50V				



REF. NO.	PART NO.	DESCRIPTION	VALUES	REF. NO.	PART NO.	DESCRIPTION	VALUES
<u>IC</u>				R9509	1-216-857-11	METAL CHIP	1M 5% 1/10W
IC9500	6-706-257-01	IC	FMS6418AM16X	R9510	1-218-665-11	METAL CHIP	75 0.50% 1/10W
IC9502	6-704-819-01	IC	CS4335-KSZR	R9511	1-216-803-11	METAL CHIP	33 5% 1/10W
IC9503	6-704-407-01	IC	PQ1CZ41H2ZPH	R9512	1-218-665-11	METAL CHIP	75 0.50% 1/10W
IC9504	6-704-001-01	IC	BR24L02F-WE2	R9513	1-218-665-11	METAL CHIP	75 0.50% 1/10W
IC9506	6-703-042-01	IC	CD4052BNSR	R9514	1-218-665-11	METAL CHIP	75 0.50% 1/10W
IC9509	6-550-014-01	TRANSISTOR	SSM6N15FU(TE85R)	R9515	1-218-665-11	METAL CHIP	75 0.50% 1/10W
IC9514	8-759-331-71	IC	NJM4558E(TE2)	R9516	1-218-665-11	METAL CHIP	75 0.50% 1/10W
IC9517	6-804-248-01	IC	HD64F3694FXV-DA4	R9517	1-218-665-11	METAL CHIP	75 0.50% 1/10W
IC9521	8-759-642-22	IC	UPC29M05T-E2	R9518	1-216-857-11	METAL CHIP	1M 5% 1/10W
<u>JACK</u>				R9519	1-216-803-11	METAL CHIP	33 5% 1/10W
J9503	1-794-623-11	JACK, PIN 2P		R9520	1-216-816-11	METAL CHIP	390 5% 1/10W
<u>COIL</u>				R9526	1-218-716-11	METAL CHIP	10K 0.50% 1/10W
L9501	1-416-948-21	INDUCTOR	10μH	R9528	1-216-837-11	METAL CHIP	22K 5% 1/10W
L9502	1-400-303-21	INDUCTOR	68μH	R9529	1-216-850-11	METAL CHIP	270K 5% 1/10W
<u>IC LINK</u>				R9530	1-216-821-11	METAL CHIP	1K 5% 1/10W
PS9500	1-576-415-21	FUSE	2A 32V	R9531	1-216-829-11	METAL CHIP	4.7K 5% 1/10W
<u>TRANSISTOR</u>				R9532	1-218-694-11	METAL CHIP	1.2K 0.50% 1/10W
Q9501	8-729-024-88	TRANSISTOR	MUN2212T1	R9533	1-216-825-11	METAL CHIP	2.2K 5% 1/10W
Q9502	8-729-421-22	TRANSISTOR	UN2211	R9534	1-218-686-11	METAL CHIP	560 0.50% 1/10W
Q9503	8-729-027-62	TRANSISTOR	DTC144WKA-T146	R9535	1-216-845-11	METAL CHIP	100K 5% 1/10W
Q9506	8-729-024-88	TRANSISTOR	MUN2212T1	R9538	1-218-823-11	METAL CHIP	100 0.50% 1/10W
Q9511	8-729-421-22	TRANSISTOR	UN2211	R9539	1-216-821-11	METAL CHIP	1K 5% 1/10W
Q9514	8-729-027-62	TRANSISTOR	DTC144WKA-T146	R9540	1-216-829-11	METAL CHIP	4.7K 5% 1/10W
Q9516	8-729-421-22	TRANSISTOR	UN2211	R9541	1-218-694-11	METAL CHIP	1.2K 0.50% 1/10W
Q9517	8-729-421-22	TRANSISTOR	UN2211	R9542	1-216-850-11	METAL CHIP	270K 5% 1/10W
<u>RESISTOR</u>				R9543	1-218-686-11	METAL CHIP	560 0.50% 1/10W
R9501	1-218-665-11	METAL CHIP	75 0.50% 1/10W	R9544	1-218-706-11	METAL CHIP	3.9K 0.50% 1/10W
R9502	1-218-665-11	METAL CHIP	75 0.50% 1/10W	R9546	1-218-706-11	METAL CHIP	3.9K 0.50% 1/10W
R9505	1-216-841-11	METAL CHIP	47K 5% 1/10W	R9547	1-216-845-11	METAL CHIP	100K 5% 1/10W
R9507	1-216-857-11	METAL CHIP	1M 5% 1/10W	R9548	1-218-716-11	METAL CHIP	10K 0.50% 1/10W
R9508	1-216-857-11	METAL CHIP	1M 5% 1/10W	R9552	1-216-817-11	METAL CHIP	470 5% 1/10W
				R9555	1-218-706-11	METAL CHIP	3.9K 0.50% 1/10W
				R9556	1-216-829-11	METAL CHIP	4.7K 5% 1/10W
				R9557	1-218-706-11	METAL CHIP	3.9K 0.50% 1/10W
				R9558	1-216-829-11	METAL CHIP	4.7K 5% 1/10W
				R9559	1-216-809-11	METAL CHIP	100 5% 1/10W
				R9560	1-216-864-11	SHORT CHIP	
				R9562	1-216-809-11	METAL CHIP	100 5% 1/10W
				R9563	1-218-706-11	METAL CHIP	3.9K 0.50% 1/10W
				R9564	1-216-837-11	METAL CHIP	22K 5% 1/10W
				R9565	1-216-845-11	METAL CHIP	100K 5% 1/10W
				R9566	1-216-864-11	SHORT CHIP	
				R9569	1-216-845-11	METAL CHIP	100K 5% 1/10W



REF. NO.	PART NO.	DESCRIPTION	VALUES			REF. NO.	PART NO.	DESCRIPTION	VALUES		
R9572	1-216-837-11	METAL CHIP	22K	5%	1/10W	R9891	1-216-809-11	METAL CHIP	100	5%	1/10W
R9574	1-216-809-11	METAL CHIP	100	5%	1/10W	RESISTOR BRIDGE					
R9575	1-216-809-11	METAL CHIP	100	5%	1/10W						
R9576	1-216-857-11	METAL CHIP	1M	5%	1/10W	RB9500	1-234-524-21	RES, CHIP NETWORK 33	(3216)		
R9577	1-216-857-11	METAL CHIP	1M	5%	1/10W	RB9510	1-233-576-11	RES, CHIP NETWORK 100	(3216)		
R9580	1-216-809-11	METAL CHIP	100	5%	1/10W	RB9511	1-233-574-11	RES, CHIP NETWORK 10	(3216)		
R9581	1-216-809-11	METAL CHIP	100	5%	1/10W	RB9512	1-233-574-11	RES, CHIP NETWORK 10	(3216)		
R9582	1-216-833-11	METAL CHIP	10K	5%	1/10W	RB9516	1-236-908-11	NETWORK RESISTOR(CHIP)	10K		
R9584	1-216-833-11	METAL CHIP	10K	5%	1/10W	RB9517	1-236-908-11	NETWORK RESISTOR(CHIP)	10K		
R9585	1-216-809-11	METAL CHIP	100	5%	1/10W	VARISTOR					
R9586	1-216-809-11	METAL CHIP	100	5%	1/10W						
R9592	1-216-809-11	METAL CHIP	100	5%	1/10W	VD9500	6-500-701-01	DIODE	PGB0010603NR		
R9595	1-216-817-11	METAL CHIP	470	5%	1/10W	VD9501	6-500-701-01	DIODE	PGB0010603NR		
R9597	1-216-803-11	METAL CHIP	33	5%	1/10W	VD9502	6-500-701-01	DIODE	PGB0010603NR		
R9602	1-216-809-11	METAL CHIP	100	5%	1/10W	VD9503	6-500-701-01	DIODE	PGB0010603NR		
R9606	1-216-864-11	SHORT CHIP				VD9504	6-500-701-01	DIODE	PGB0010603NR		
R9612	1-216-864-11	SHORT CHIP				VD9505	6-500-701-01	DIODE	PGB0010603NR		
R9614	1-216-809-11	METAL CHIP	100	5%	1/10W	VD9506	6-500-701-01	DIODE	PGB0010603NR		
R9615	1-216-809-11	METAL CHIP	100	5%	1/10W	VD9507	6-500-701-01	DIODE	PGB0010603NR		
R9616	1-216-809-11	METAL CHIP	100	5%	1/10W	VD9518	6-500-701-01	DIODE	PGB0010603NR		
R9623	1-216-845-11	METAL CHIP	100K	5%	1/10W	VD9519	6-500-701-01	DIODE	PGB0010603NR		
R9624	1-216-845-11	METAL CHIP	100K	5%	1/10W	CRYSTAL					
R9625	1-216-845-11	METAL CHIP	100K	5%	1/10W						
R9626	1-216-833-11	METAL CHIP	10K	5%	1/10W	X9501	1-767-984-21	VIBRATOR, CRYSTAL			
R9627	1-216-809-11	METAL CHIP	100	5%	1/10W	<div style="border: 1px solid black; padding: 2px; display: inline-block;">BH</div> * A-1071-980-A BH BOARD, COMPLETE					
R9850	1-216-833-11	METAL CHIP	10K	5%	1/10W						
R9851	1-216-821-11	METAL CHIP	1K	5%	1/10W	Due to the complexity of this board, performing component level field repairs is not recommended. If service is required, complete board replacement is the preferred repair method. Data is provided for reference only.					
R9852	1-218-644-11	METAL CHIP	10	0.50%	1/10W						
R9853	1-216-845-11	METAL CHIP	100K	5%	1/10W	CAPACITOR					
R9854	1-216-845-11	METAL CHIP	100K	5%	1/10W						
R9860	1-218-706-11	METAL CHIP	3.9K	0.50%	1/10W	C3032	1-107-826-11	CERAMIC CHIP	0.1µF	10%	16V
R9864	1-218-701-11	METAL CHIP	2.4K	0.50%	1/10W	C3040	1-162-970-11	CERAMIC CHIP	0.01µF	10%	25V
R9866	1-216-821-11	METAL CHIP	1K	5%	1/10W	C3101	1-162-964-11	CERAMIC CHIP	0.001µF	10%	50V
R9867	1-216-821-11	METAL CHIP	1K	5%	1/10W	C3102	1-162-970-11	CERAMIC CHIP	0.01µF	10%	25V
R9868	1-216-833-11	METAL CHIP	10K	5%	1/10W	C3104	1-162-970-11	CERAMIC CHIP	0.01µF	10%	25V
R9869	1-216-833-11	METAL CHIP	10K	5%	1/10W	C3105	1-162-970-11	CERAMIC CHIP	0.01µF	10%	25V
R9882	1-218-665-11	METAL CHIP	75	0.50%	1/10W	C3106	1-162-970-11	CERAMIC CHIP	0.01µF	10%	25V
R9883	1-216-838-11	METAL CHIP	27K	5%	1/10W	C3107	1-162-970-11	CERAMIC CHIP	0.01µF	10%	25V
R9884	1-218-665-11	METAL CHIP	75	0.50%	1/10W	C3108	1-162-970-11	CERAMIC CHIP	0.01µF	10%	25V
R9885	1-218-665-11	METAL CHIP	75	0.50%	1/10W	C3109	1-162-970-11	CERAMIC CHIP	0.01µF	10%	25V
R9886	1-218-665-11	METAL CHIP	75	0.50%	1/10W	C3110	1-162-970-11	CERAMIC CHIP	0.01µF	10%	25V
R9887	1-218-665-11	METAL CHIP	75	0.50%	1/10W	C3111	1-162-970-11	CERAMIC CHIP	0.01µF	10%	25V
R9888	1-218-847-11	METAL CHIP	1K	0.50%	1/10W						
R9890	1-218-665-11	METAL CHIP	75	0.50%	1/10W						



REF. NO.	PART NO.	DESCRIPTION	VALUES			REF. NO.	PART NO.	DESCRIPTION	VALUES		
C3112	1-162-970-11	CERAMIC CHIP	0.01μF	10%	25V	C3156	1-107-826-11	CERAMIC CHIP	0.1μF	10%	16V
C3113	1-137-710-11	CERAMIC CHIP	10μF	20%	6.3V	C3157	1-137-710-11	CERAMIC CHIP	10μF	20%	6.3V
C3114	1-107-826-11	CERAMIC CHIP	0.1μF	10%	16V	C3158	1-107-826-11	CERAMIC CHIP	0.1μF	10%	16V
C3115	1-107-826-11	CERAMIC CHIP	0.1μF	10%	16V	C3160	1-107-826-11	CERAMIC CHIP	0.1μF	10%	16V
C3116	1-126-205-11	ELECT CHIP	47μF	20%	6.3V	C3163	1-100-507-91	CERAMIC CHIP	4.7μF	20%	6.3V
C3117	1-162-970-11	CERAMIC CHIP	0.01μF	10%	25V	C3165	1-107-826-11	CERAMIC CHIP	0.1μF	10%	16V
C3118	1-107-826-11	CERAMIC CHIP	0.1μF	10%	16V	C3167	1-162-970-11	CERAMIC CHIP	0.01μF	10%	25V
C3119	1-162-970-11	CERAMIC CHIP	0.01μF	10%	25V	C3169	1-126-205-11	ELECT CHIP	47μF	20%	6.3V
C3120	1-100-507-91	CERAMIC CHIP	4.7μF	20%	6.3V	C3170	1-126-205-11	ELECT CHIP	47μF	20%	6.3V
C3121	1-162-970-11	CERAMIC CHIP	0.01μF	10%	25V	C3171	1-107-826-11	CERAMIC CHIP	0.1μF	10%	16V
C3122	1-100-507-91	CERAMIC CHIP	4.7μF	20%	6.3V	C3173	1-162-970-11	CERAMIC CHIP	0.01μF	10%	25V
C3123	1-162-970-11	CERAMIC CHIP	0.01μF	10%	25V	C3178	1-162-970-11	CERAMIC CHIP	0.01μF	10%	25V
C3124	1-162-970-11	CERAMIC CHIP	0.01μF	10%	25V	C3179	1-162-970-11	CERAMIC CHIP	0.01μF	10%	25V
C3125	1-162-970-11	CERAMIC CHIP	0.01μF	10%	25V	C3184	1-162-927-11	CERAMIC CHIP	100pF	5%	50V
C3126	1-162-970-11	CERAMIC CHIP	0.01μF	10%	25V	C3185	1-162-927-11	CERAMIC CHIP	100pF	5%	50V
C3127	1-162-970-11	CERAMIC CHIP	0.01μF	10%	25V	C3188	1-162-927-11	CERAMIC CHIP	100pF	5%	50V
C3128	1-162-970-11	CERAMIC CHIP	0.01μF	10%	25V	C3189	1-162-927-11	CERAMIC CHIP	100pF	5%	50V
C3129	1-162-970-11	CERAMIC CHIP	0.01μF	10%	25V	C3207	1-162-970-11	CERAMIC CHIP	0.01μF	10%	25V
C3130	1-162-970-11	CERAMIC CHIP	0.01μF	10%	25V	C3208	1-162-970-11	CERAMIC CHIP	0.01μF	10%	25V
C3131	1-162-970-11	CERAMIC CHIP	0.01μF	10%	25V	C3209	1-126-205-11	ELECT CHIP	47μF	20%	6.3V
C3132	1-162-970-11	CERAMIC CHIP	0.01μF	10%	25V	C3301	1-162-923-11	CERAMIC CHIP	47pF	5%	50V
C3133	1-162-970-11	CERAMIC CHIP	0.01μF	10%	25V	C3302	1-162-923-11	CERAMIC CHIP	47pF	5%	50V
C3134	1-162-970-11	CERAMIC CHIP	0.01μF	10%	25V	C3305	1-137-710-11	CERAMIC CHIP	10μF	20%	6.3V
C3135	1-162-970-11	CERAMIC CHIP	0.01μF	10%	25V	C3306	1-162-970-11	CERAMIC CHIP	0.01μF	10%	25V
C3136	1-162-970-11	CERAMIC CHIP	0.01μF	10%	25V	C3307	1-162-970-11	CERAMIC CHIP	0.01μF	10%	25V
C3137	1-162-970-11	CERAMIC CHIP	0.01μF	10%	25V	C3311	1-162-970-11	CERAMIC CHIP	0.01μF	10%	25V
C3138	1-162-970-11	CERAMIC CHIP	0.01μF	10%	25V	C3312	1-162-970-11	CERAMIC CHIP	0.01μF	10%	25V
C3139	1-162-970-11	CERAMIC CHIP	0.01μF	10%	25V	C3313	1-162-970-11	CERAMIC CHIP	0.01μF	10%	25V
C3140	1-162-970-11	CERAMIC CHIP	0.01μF	10%	25V	C3314	1-162-970-11	CERAMIC CHIP	0.01μF	10%	25V
C3141	1-162-970-11	CERAMIC CHIP	0.01μF	10%	25V	C3315	1-162-970-11	CERAMIC CHIP	0.01μF	10%	25V
C3142	1-162-970-11	CERAMIC CHIP	0.01μF	10%	25V	C3316	1-162-970-11	CERAMIC CHIP	0.01μF	10%	25V
C3143	1-162-970-11	CERAMIC CHIP	0.01μF	10%	25V	C3317	1-162-970-11	CERAMIC CHIP	0.01μF	10%	25V
C3144	1-162-970-11	CERAMIC CHIP	0.01μF	10%	25V	C3318	1-162-970-11	CERAMIC CHIP	0.01μF	10%	25V
C3145	1-162-970-11	CERAMIC CHIP	0.01μF	10%	25V	C3320	1-162-970-11	CERAMIC CHIP	0.01μF	10%	25V
C3146	1-137-710-11	CERAMIC CHIP	10μF	20%	6.3V	C3321	1-162-970-11	CERAMIC CHIP	0.01μF	10%	25V
C3147	1-162-970-11	CERAMIC CHIP	0.01μF	10%	25V	C3324	1-162-970-11	CERAMIC CHIP	0.01μF	10%	25V
C3148	1-162-970-11	CERAMIC CHIP	0.01μF	10%	25V	C3325	1-162-970-11	CERAMIC CHIP	0.01μF	10%	25V
C3149	1-162-970-11	CERAMIC CHIP	0.01μF	10%	25V	C3328	1-162-970-11	CERAMIC CHIP	0.01μF	10%	25V
C3150	1-162-970-11	CERAMIC CHIP	0.01μF	10%	25V	C3329	1-162-970-11	CERAMIC CHIP	0.01μF	10%	25V
C3151	1-162-970-11	CERAMIC CHIP	0.01μF	10%	25V	C3330	1-162-970-11	CERAMIC CHIP	0.01μF	10%	25V
C3152	1-162-970-11	CERAMIC CHIP	0.01μF	10%	25V	C3331	1-162-970-11	CERAMIC CHIP	0.01μF	10%	25V
C3153	1-107-826-11	CERAMIC CHIP	0.1μF	10%	16V	C3332	1-162-970-11	CERAMIC CHIP	0.01μF	10%	25V
C3154	1-137-710-11	CERAMIC CHIP	10μF	20%	6.3V	C3333	1-162-970-11	CERAMIC CHIP	0.01μF	10%	25V
C3155	1-107-826-11	CERAMIC CHIP	0.1μF	10%	16V	C3334	1-162-970-11	CERAMIC CHIP	0.01μF	10%	25V



REF. NO.	PART NO.	DESCRIPTION	VALUES	REF. NO.	PART NO.	DESCRIPTION	VALUES
C3335	1-162-970-11	CERAMIC CHIP	0.01μF 10% 25V	C3383	1-162-970-11	CERAMIC CHIP	0.01μF 10% 25V
C3337	1-107-826-11	CERAMIC CHIP	0.1μF 10% 16V	C3384	1-107-826-11	CERAMIC CHIP	0.1μF 10% 16V
C3338	1-162-970-11	CERAMIC CHIP	0.01μF 10% 25V	C3385	1-126-205-11	ELECT CHIP	47μF 20% 6.3V
C3340	1-162-970-11	CERAMIC CHIP	0.01μF 10% 25V	C3386	1-126-205-11	ELECT CHIP	47μF 20% 6.3V
C3341	1-165-884-91	CERAMIC CHIP	2.2μF 10% 6.3V	C3387	1-107-826-11	CERAMIC CHIP	0.1μF 10% 16V
C3342	1-162-970-11	CERAMIC CHIP	0.01μF 10% 25V	C3388	1-100-507-91	CERAMIC CHIP	4.7μF 20% 6.3V
C3343	1-162-970-11	CERAMIC CHIP	0.01μF 10% 25V	C3389	1-107-826-11	CERAMIC CHIP	0.1μF 10% 16V
C3344	1-162-917-11	CERAMIC CHIP	15pF 5% 50V	C3390	1-126-205-11	ELECT CHIP	47μF 20% 6.3V
C3345	1-162-917-11	CERAMIC CHIP	15pF 5% 50V	C3391	1-107-826-11	CERAMIC CHIP	0.1μF 10% 16V
C3346	1-165-884-91	CERAMIC CHIP	2.2μF 10% 6.3V	C3392	1-137-710-11	CERAMIC CHIP	10μF 20% 6.3V
C3347	1-107-826-11	CERAMIC CHIP	0.1μF 10% 16V	C3393	1-137-710-11	CERAMIC CHIP	10μF 20% 6.3V
C3348	1-107-826-11	CERAMIC CHIP	0.1μF 10% 16V	C3394	1-107-826-11	CERAMIC CHIP	0.1μF 10% 16V
C3349	1-107-826-11	CERAMIC CHIP	0.1μF 10% 16V	C3395	1-107-826-11	CERAMIC CHIP	0.1μF 10% 16V
C3350	1-107-826-11	CERAMIC CHIP	0.1μF 10% 16V	C3397	1-100-507-91	CERAMIC CHIP	4.7μF 20% 6.3V
C3351	1-162-970-11	CERAMIC CHIP	0.01μF 10% 25V	C3398	1-107-826-11	CERAMIC CHIP	0.1μF 10% 16V
C3352	1-165-884-91	CERAMIC CHIP	2.2μF 10% 6.3V	C3399	1-162-970-11	CERAMIC CHIP	0.01μF 10% 25V
C3353	1-107-826-11	CERAMIC CHIP	0.1μF 10% 16V	C3400	1-164-230-11	CERAMIC CHIP	220pF 5% 50V
C3354	1-162-970-11	CERAMIC CHIP	0.01μF 10% 25V	C3402	1-107-826-11	CERAMIC CHIP	0.1μF 10% 16V
C3355	1-107-826-11	CERAMIC CHIP	0.1μF 10% 16V	C3403	1-162-970-11	CERAMIC CHIP	0.01μF 10% 25V
C3356	1-100-507-91	CERAMIC CHIP	4.7μF 20% 6.3V	C3404	1-162-970-11	CERAMIC CHIP	0.01μF 10% 25V
C3357	1-107-826-11	CERAMIC CHIP	0.1μF 10% 16V			CONNECTOR	
C3358	1-107-826-11	CERAMIC CHIP	0.1μF 10% 16V	* CN3001	1-816-448-11	CONNECTOR, BOARD TO BOARD	50P
C3359	1-107-826-11	CERAMIC CHIP	0.1μF 10% 16V			FERRITE BEAD	
C3360	1-162-970-11	CERAMIC CHIP	0.01μF 10% 25V	FB3101	1-414-228-11	FERRITE	0μH
C3361	1-100-507-91	CERAMIC CHIP	4.7μF 20% 6.3V	FB3102	1-400-180-21	INDUCTOR	0μH
C3362	1-125-837-91	CERAMIC CHIP	1μF 10% 6.3V	FB3103	1-400-180-21	INDUCTOR	0μH
C3363	1-162-970-11	CERAMIC CHIP	0.01μF 10% 25V	FB3301	1-400-180-21	INDUCTOR	0μH
C3365	1-107-826-11	CERAMIC CHIP	0.1μF 10% 16V	FB3302	1-400-180-21	INDUCTOR	0μH
C3366	1-107-826-11	CERAMIC CHIP	0.1μF 10% 16V			FILTER	
C3367	1-164-230-11	CERAMIC CHIP	220pF 5% 50V	FL3001	1-234-177-21	FERRITE	0μH
C3368	1-100-507-91	CERAMIC CHIP	4.7μF 20% 6.3V	FL3100	1-234-677-21	FILTER, EMI	
C3370	1-162-970-11	CERAMIC CHIP	0.01μF 10% 25V	FL3101	1-234-560-21	FILTER, LOW PASS	
C3371	1-162-970-11	CERAMIC CHIP	0.01μF 10% 25V	FL3102	1-234-559-21	FILTER, LOW PASS	
C3372	1-162-970-11	CERAMIC CHIP	0.01μF 10% 25V	FL3103	1-234-559-21	FILTER, LOW PASS	
C3373	1-162-970-11	CERAMIC CHIP	0.01μF 10% 25V	FL3105	1-234-177-21	FERRITE	0μH
C3374	1-162-970-11	CERAMIC CHIP	0.01μF 10% 25V	FL3301	1-234-854-21	FILTER, LOW PASS (SMD)	
C3375	1-100-507-91	CERAMIC CHIP	4.7μF 20% 6.3V				
C3376	1-126-205-11	ELECT CHIP	47μF 20% 6.3V				
C3377	1-162-970-11	CERAMIC CHIP	0.01μF 10% 25V				
C3378	1-126-205-11	ELECT CHIP	47μF 20% 6.3V				
C3379	1-162-970-11	CERAMIC CHIP	0.01μF 10% 25V				
C3380	1-162-970-11	CERAMIC CHIP	0.01μF 10% 25V				
C3381	1-107-826-11	CERAMIC CHIP	0.1μF 10% 16V				
C3382	1-100-507-91	CERAMIC CHIP	4.7μF 20% 6.3V				



REF. NO.	PART NO.	DESCRIPTION	VALUES	REF. NO.	PART NO.	DESCRIPTION	VALUES
<u>IC</u>				<u>RESISTOR</u>			
IC3101	8-752-425-02	IC	CXD3802BQ	R3024	1-216-827-11	METAL CHIP	3.3K 5% 1/10W
IC3102	6-705-983-01	IC	IS42S32200B-6TL-TR	R3035	1-543-949-22	FERRITE	0μH
IC3103	6-706-706-01	IC	SN10503PWPR	R3036	1-543-949-22	FERRITE	0μH
IC3105	8-759-833-72	IC	NJM2870F25-TE2	R3037	1-543-949-22	FERRITE	0μH
IC3106	6-705-403-01	IC	PQ070XZ01ZPH	R3041	1-543-949-22	FERRITE	0μH
IC3205	6-705-403-01	IC	PQ070XZ01ZPH	R3042	1-543-949-22	FERRITE	0μH
IC3301	8-753-215-81	IC	CXD3808Q	R3049	1-543-949-22	FERRITE	0μH
IC3302	6-705-983-01	IC	IS42S32200B-6TL-TR	R3055	1-543-949-22	FERRITE	0μH
IC3303	8-759-649-46	IC	SN74AHC1G08DCKR	R3056	1-543-949-22	FERRITE	0μH
IC3306	8-759-649-46	IC	SN74AHC1G08DCKR	R3101	1-216-803-11	METAL CHIP	33 5% 1/10W
IC3310	8-759-833-72	IC	NJM2870F25-TE2	R3102	1-218-847-11	METAL CHIP	1K 0.50% 1/10W
IC3311	8-759-833-72	IC	NJM2870F25-TE2	R3103	1-216-819-11	METAL CHIP	680 5% 1/10W
				R3104	1-216-805-11	METAL CHIP	47 5% 1/10W
				R3105	1-218-830-11	METAL CHIP	200 0.50% 1/10W
				R3106	1-216-809-11	METAL CHIP	100 5% 1/10W
<u>COIL</u>							
L3101	1-469-555-21	INDUCTOR	10μH	R3107	1-216-819-11	METAL CHIP	680 5% 1/10W
L3102	1-469-555-21	INDUCTOR	10μH	R3108	1-218-830-11	METAL CHIP	200 0.50% 1/10W
L3105	1-469-549-21	INDUCTOR	1μH	R3109	1-216-819-11	METAL CHIP	680 5% 1/10W
L3307	1-469-555-21	INDUCTOR	10μH	R3110	1-216-805-11	METAL CHIP	47 5% 1/10W
L3308	1-469-555-21	INDUCTOR	10μH	R3111	1-218-834-11	METAL CHIP	300 0.50% 1/10W
L3309	1-469-555-21	INDUCTOR	10μH	R3112	1-216-809-11	METAL CHIP	100 5% 1/10W
L3310	1-469-555-21	INDUCTOR	10μH	R3113	1-216-819-11	METAL CHIP	680 5% 1/10W
L3311	1-469-555-21	INDUCTOR	10μH	R3114	1-218-834-11	METAL CHIP	300 0.50% 1/10W
L3315	1-469-549-21	INDUCTOR	1μH	R3115	1-216-809-11	METAL CHIP	100 5% 1/10W
L3316	1-469-555-21	INDUCTOR	10μH	R3116	1-216-809-11	METAL CHIP	100 5% 1/10W
L3317	1-412-026-11	INDUCTOR	1μH				
				R3117	1-216-819-11	METAL CHIP	680 5% 1/10W
				R3118	1-216-809-11	METAL CHIP	100 5% 1/10W
				R3119	1-216-805-11	METAL CHIP	47 5% 1/10W
				R3120	1-218-834-11	METAL CHIP	300 0.50% 1/10W
				R3121	1-216-809-11	METAL CHIP	100 5% 1/10W
				R3122	1-216-819-11	METAL CHIP	680 5% 1/10W
				R3123	1-218-834-11	METAL CHIP	300 0.50% 1/10W
				R3124	1-216-809-11	METAL CHIP	100 5% 1/10W
				R3125	1-218-847-11	METAL CHIP	1K 0.50% 1/10W
				R3129	1-216-805-11	METAL CHIP	47 5% 1/10W
				R3130	1-216-805-11	METAL CHIP	47 5% 1/10W
				R3133	1-216-809-11	METAL CHIP	100 5% 1/10W
				R3134	1-216-809-11	METAL CHIP	100 5% 1/10W
				R3135	1-543-949-22	FERRITE	0μH
				R3136	1-543-949-22	FERRITE	0μH
				R3141	1-218-847-11	METAL CHIP	1K 0.50% 1/10W
				R3142	1-218-847-11	METAL CHIP	1K 0.50% 1/10W
<u>TRANSISTOR</u>							
Q3101	8-729-102-07	TRANSISTOR	2SC2223-F13				
Q3102	8-729-122-63	TRANSISTOR	2SA1226-E4				
Q3103	8-729-102-07	TRANSISTOR	2SC2223-F13				
Q3104	8-729-122-63	TRANSISTOR	2SA1226-E4				
Q3105	8-729-102-07	TRANSISTOR	2SC2223-F13				
Q3106	8-729-122-63	TRANSISTOR	2SA1226-E4				
Q3113	8-729-010-25	TRANSISTOR	MSD601-RT1				
Q3306	8-729-028-28	TRANSISTOR	2SK2036(TE85L)				
Q3307	8-729-028-28	TRANSISTOR	2SK2036(TE85L)				
Q3308	8-729-010-25	TRANSISTOR	MSD601-RT1				
Q3310	8-729-010-25	TRANSISTOR	MSD601-RT1				
Q3312	8-729-010-25	TRANSISTOR	MSD601-RT1				
Q3313	8-729-010-05	TRANSISTOR	MSB709-RT1				
Q3314	8-729-010-25	TRANSISTOR	MSD601-RT1				



REF. NO.	PART NO.	DESCRIPTION	VALUES			REF. NO.	PART NO.	DESCRIPTION	VALUES		
R3143	1-218-847-11	METAL CHIP	1K	0.50%	1/10W	R3369	1-216-813-11	METAL CHIP	220	5%	1/10W
R3144	1-218-849-11	METAL CHIP	1.2K	0.50%	1/10W	R3370	1-216-851-11	METAL CHIP	330K	5%	1/10W
R3145	1-218-849-11	METAL CHIP	1.2K	0.50%	1/10W	R3372	1-218-849-11	METAL CHIP	1.2K	0.50%	1/10W
R3146	1-218-849-11	METAL CHIP	1.2K	0.50%	1/10W	R3373	1-218-859-11	METAL CHIP	3.3K	0.50%	1/10W
R3147	1-218-863-11	METAL CHIP	4.7K	0.50%	1/10W	R3374	1-216-817-11	METAL CHIP	470	5%	1/10W
R3148	1-218-863-11	METAL CHIP	4.7K	0.50%	1/10W	R3375	1-216-809-11	METAL CHIP	100	5%	1/10W
R3149	1-218-863-11	METAL CHIP	4.7K	0.50%	1/10W	R3376	1-216-809-11	METAL CHIP	100	5%	1/10W
R3163	1-218-851-11	METAL CHIP	1.5K	0.50%	1/10W	R3377	1-216-809-11	METAL CHIP	100	5%	1/10W
R3164	1-218-863-11	METAL CHIP	4.7K	0.50%	1/10W	R3378	1-216-809-11	METAL CHIP	100	5%	1/10W
R3170	1-216-801-11	METAL CHIP	22	5%	1/10W	R3383	1-216-805-11	METAL CHIP	47	5%	1/10W
R3172	1-216-864-11	SHORT CHIP				R3392	1-216-864-11	SHORT CHIP			
R3176	1-216-864-11	SHORT CHIP				R3393	1-216-864-11	SHORT CHIP			
R3181	1-216-833-11	METAL CHIP	10K	5%	1/10W	R3395	1-216-817-11	METAL CHIP	470	5%	1/10W
R3182	1-216-833-11	METAL CHIP	10K	5%	1/10W	R3396	1-216-864-11	SHORT CHIP			
R3186	1-216-833-11	METAL CHIP	10K	5%	1/10W	R3402	1-216-864-11	SHORT CHIP			
R3190	1-216-864-11	SHORT CHIP				R3403	1-216-813-11	METAL CHIP	220	5%	1/10W
R3199	1-216-855-11	METAL CHIP	680K	5%	1/10W	R3404	1-216-837-11	METAL CHIP	22K	5%	1/10W
R3280	1-218-838-11	METAL CHIP	430	0.50%	1/10W	R3406	1-216-833-11	METAL CHIP	10K	5%	1/10W
R3281	1-218-847-11	METAL CHIP	1K	0.50%	1/10W	R3407	1-216-864-11	SHORT CHIP			
R3282	1-218-873-11	METAL CHIP	12K	0.50%	1/10W	R3409	1-216-801-11	METAL CHIP	22	5%	1/10W
R3301	1-216-864-11	SHORT CHIP				R3416	1-216-801-11	METAL CHIP	22	5%	1/10W
R3322	1-216-805-11	METAL CHIP	47	5%	1/10W	R3419	1-216-801-11	METAL CHIP	22	5%	1/10W
R3323	1-216-809-11	METAL CHIP	100	5%	1/10W	R3440	1-216-864-11	SHORT CHIP			
R3324	1-216-809-11	METAL CHIP	100	5%	1/10W						
R3326	1-216-809-11	METAL CHIP	100	5%	1/10W						
R3327	1-216-809-11	METAL CHIP	100	5%	1/10W						
R3333	1-216-833-11	METAL CHIP	10K	5%	1/10W						
R3334	1-216-833-11	METAL CHIP	10K	5%	1/10W						
R3351	1-216-809-11	METAL CHIP	100	5%	1/10W						
R3352	1-216-809-11	METAL CHIP	100	5%	1/10W						
R3355	1-218-863-11	METAL CHIP	4.7K	0.50%	1/10W						
R3356	1-216-821-11	METAL CHIP	1K	5%	1/10W						
R3357	1-218-854-11	METAL CHIP	2K	0.50%	1/10W						
R3358	1-216-809-11	METAL CHIP	100	5%	1/10W						
R3359	1-216-809-11	METAL CHIP	100	5%	1/10W						
R3360	1-216-805-11	METAL CHIP	47	5%	1/10W						
R3361	1-216-864-11	SHORT CHIP									
R3362	1-216-817-11	METAL CHIP	470	5%	1/10W						
R3363	1-218-854-11	METAL CHIP	2K	0.50%	1/10W						
R3364	1-218-826-11	METAL CHIP	130	0.50%	1/10W						
R3365	1-218-826-11	METAL CHIP	130	0.50%	1/10W						
R3366	1-218-826-11	METAL CHIP	130	0.50%	1/10W						
R3367	1-216-805-11	METAL CHIP	47	5%	1/10W						
R3368	1-218-829-11	METAL CHIP	180	0.50%	1/10W						

<u>RESISTOR BRIDGE</u>											
RB3102	1-233-576-11	RES, CHIP NETWORK 100	(3216)								
RB3103	1-233-576-11	RES, CHIP NETWORK 100	(3216)								
RB3104	1-233-576-11	RES, CHIP NETWORK 100	(3216)								
RB3105	1-233-576-11	RES, CHIP NETWORK 100	(3216)								
RB3106	1-233-576-11	RES, CHIP NETWORK 100	(3216)								
RB3107	1-233-576-11	RES, CHIP NETWORK 100	(3216)								
RB3108	1-233-576-11	RES, CHIP NETWORK 100	(3216)								
RB3109	1-233-576-11	RES, CHIP NETWORK 100	(3216)								
RB3110	1-233-576-11	RES, CHIP NETWORK 100	(3216)								
RB3111	1-233-576-11	RES, CHIP NETWORK 100	(3216)								
RB3112	1-233-576-11	RES, CHIP NETWORK 100	(3216)								
RB3113	1-233-576-11	RES, CHIP NETWORK 100	(3216)								
RB3114	1-236-908-11	NETWORK RESISTOR(CHIP)	10K								
RB3115	1-236-908-11	NETWORK RESISTOR(CHIP)	10K								
RB3116	1-236-908-11	NETWORK RESISTOR(CHIP)	10K								
RB3117	1-236-908-11	NETWORK RESISTOR(CHIP)	10K								
RB3303	1-239-409-11	NETWORK RESISTOR(CHIP)	47								
RB3304	1-239-409-11	NETWORK RESISTOR(CHIP)	47								

BH QH HA2 SR

REF. NO.	PART NO.	DESCRIPTION	VALUES
RB3305	1-239-409-11	NETWORK RESISTOR(CHIP)	47
RB3306	1-239-409-11	NETWORK RESISTOR(CHIP)	47
RB3309	1-239-409-11	NETWORK RESISTOR(CHIP)	47
RB3310	1-239-409-11	NETWORK RESISTOR(CHIP)	47
RB3311	1-239-409-11	NETWORK RESISTOR(CHIP)	47
RB3312	1-239-409-11	NETWORK RESISTOR(CHIP)	47

CRYSTAL

X3101	1-813-373-11	OSCILLATOR, CRYSTAL
X3301	1-813-114-21	VIBRATOR, CRYSTAL

QH

A-1303-030-A QH BOARD, COMPLETE

Due to the complexity of this board, performing component level field repairs is not recommended. If service is required, complete board replacement is the preferred repair method. Data is provided for reference only.

HA2

* **A-1057-706-A HA2 BOARD, MOUNTED**

CAPACITOR

C1201	1-126-157-11	ELECT	10µF	20%	16V
-------	--------------	-------	------	-----	-----

CONNECTOR

* CN1201	1-564-524-11	PLUG, CONNECTOR	9P
----------	--------------	-----------------	----

DIODE

D1201	8-719-053-43	DIODE	SLR-325VCT31
D1202	8-719-053-43	DIODE	SLR-325VCT31
D1203	8-719-977-28	DIODE	DTZ10B

IC

IC1201	8-742-211-20	HYB IC	SBX3071-71
--------	--------------	--------	------------

REF. NO.	PART NO.	DESCRIPTION	VALUES
----------	----------	-------------	--------

RESISTOR

R1201	1-216-809-11	METAL CHIP	100 5% 1/10W
R1202	1-216-817-11	METAL CHIP	470 5% 1/10W
R1203	1-216-819-11	METAL CHIP	680 5% 1/10W
R1204	1-216-821-11	METAL CHIP	1K 5% 1/10W
R1205	1-216-825-11	METAL CHIP	2.2K 5% 1/10W
R1206	1-216-817-11	METAL CHIP	470 5% 1/10W
R1207	1-216-817-11	METAL CHIP	470 5% 1/10W
R1208	1-216-797-11	METAL CHIP	10 5% 1/10W
R1209	1-216-837-11	METAL CHIP	22K 5% 1/10W

SWITCH

S1201	1-572-198-11	SWITCH, KEYBOARD
S1202	1-572-198-11	SWITCH, KEYBOARD
S1203	1-572-198-11	SWITCH, KEYBOARD
S1204	1-572-198-11	SWITCH, KEYBOARD
S1205	1-572-198-11	SWITCH, KEYBOARD
S1206	1-572-198-11	SWITCH, KEYBOARD
S1207	1-572-198-11	SWITCH, KEYBOARD

SR

* **A-1405-083-A SR BOARD, MOUNTED**

Due to the complexity of this board, performing component level field repairs is not recommended. If service is required, complete board replacement is the preferred repair method. Data is provided for reference only.

CONNECTOR

* CN9901	1-564-506-11	PLUG, CONNECTOR	3P
----------	--------------	-----------------	----

DIODE

D9901	8-719-036-94	DIODE	RD5.6SB-T1
-------	--------------	-------	------------

SWITCH

SB9901	1-477-983-21	PHOTO SENSOR
--------	--------------	--------------

HB3

REF. NO.	PART NO.	DESCRIPTION	VALUES	REF. NO.	PART NO.	DESCRIPTION	VALUES
HB3				MISCELLANEOUS			
*	A-1059-471-A	HB3 BOARD, MOUNTED		7-600-005-96		BLACK ACETATE (NO.570F) 46X50M	
	CAPACITOR			7-600-003-52		TAPE, ACETATE (2142) 46X30M	
C1100	1-126-960-11	ELECT	1μF 20% 50V	7-600-001-97		TAPE, ACETATE (P2412) 25X30M	
C1101	1-126-960-11	ELECT	1μF 20% 50V	7-600-019-13		TAPE, ACETATE (P2412HD) 25MMX30M	
	CONNECTOR			ACCESSORIES AND PACKING			
*	CN1101	1-564-526-11	PLUG, CONNECTOR 11P	4-041-426-01		BAG, PROTECTION (KDP-51WS655 ONLY)	
	DIODE			*	4-076-420-01	BAG, PROTECTION (KDP-57WS655 ONLY)	
D1100	8-719-977-28	DIODE	DTZ10B	*	2-159-717-01	CARTON, INDIVIDUAL (KDP-51WS655 ONLY)	
D1101	8-719-977-28	DIODE	DTZ10B	*	2-159-718-01	CARTON, INDIVIDUAL (KDP-57WS655 ONLY)	
D1103	8-719-977-28	DIODE	DTZ10B	*	2-021-823-01	CUSHION, LOWER (KDP-51WS655 ONLY)	
	JACK			*	2-021-825-01	CUSHION, LOWER (KDP-57WS655 ONLY)	
J1101	1-770-361-11	TERMINAL BLOCK, S		*	2-021-824-01	CUSHION, UPPER (KDP-51WS655 ONLY)	
	RESISTOR			*	4-094-656-11	CUSHION, UPPER (KDP-57WS655 ONLY)	
R1100	1-216-853-11	METAL CHIP	470K 5% 1/10W	2-025-243-11		MANUAL, INSTRUCTION	
R1101	1-216-853-11	METAL CHIP	470K 5% 1/10W	2-148-833-01		GUIDE, QUICK SET-UP	
R1102	1-218-285-11	METAL CHIP	75 5% 1/10W	*	4-042-463-01	SHEET, PROTECTION	
R1103	1-218-285-11	METAL CHIP	75 5% 1/10W	*	4-094-659-01	TRAY (KDP-57WS655 ONLY)	
R1106	1-216-821-11	METAL CHIP	1K 5% 1/10W	REMOTE COMMANDER			
R1107	1-218-285-11	METAL CHIP	75 5% 1/10W	1-478-918-11		REMOTE COMMANDER (RM-Y915)	
				3-072-138-01		BATTERY COVER (for RM-Y915)	

Sony Corporation
 Sony Technology Center
 Technical Services
 Service Promotion Department

In an effort to reduce the size of this pdf file the tiled schematics are not attached to this Service Manual. To receive a complete set of the tiled schematics for this manual please submit a request to Service_Promotion@am.sony.com.